

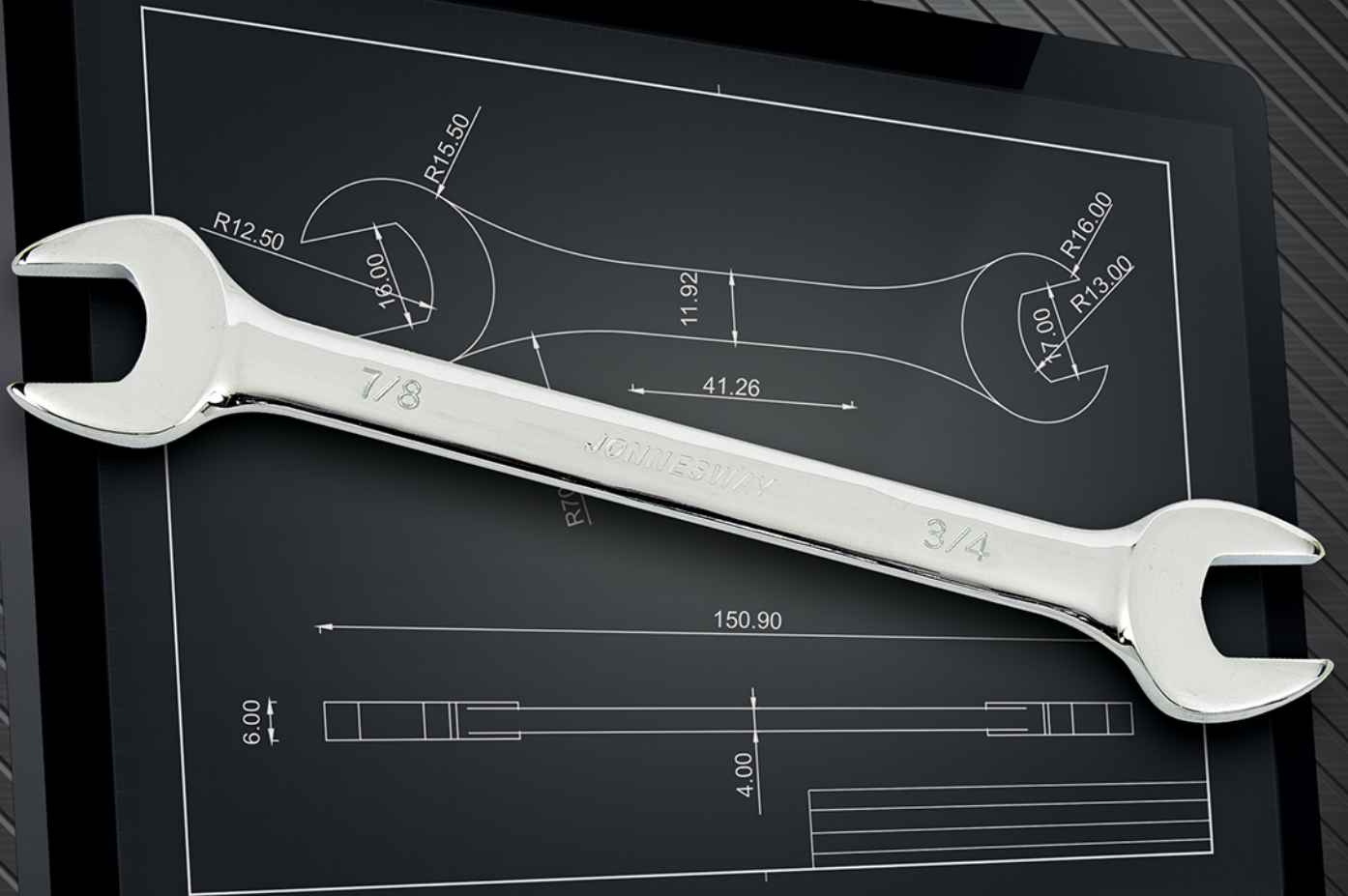

JONNESWAY®

Ferramentas Profissionais Manuais e Pneumáticas



2020

Ferramentas Profissionais Manuais e Pneumáticas

JONNESWAY®

de profissionais
para profissionais

2020



JONNESWAY

Ferramentas Profissionais Manuais e Pneumáticas



Este catálogo anula e substitui todas as edições anteriores.
Todos os preços apresentados nesta tabela estão sujeitos a IVA à taxa legal em vigor.

A Jonnesway está em constante desenvolvimento dos seus produtos, portanto, os modelos, composições, características técnicas, físicas, design e preços podem ser alterados, substituídos ou mesmo retirados deste catálogo sem aviso prévio e sem obrigação de efetuar qualquer alteração nas ferramentas e/ou equipamentos vendidos anteriormente. As capacidades indicadas para os produtos, são as que resultaram dos ensaios realizados nos laboratórios da Jonnesway, não sendo portanto contratuais.



www.jonneswaytools.com





















facebook.com/jonneswaytools



Lusilectra
Salvador Caetano

Catálogo versão 3.3 Portugal
Entra em vigor em janeiro de 2020

Outros Equipamentos	Outros equipamentos	5-10	
Carros e Composições de Ferramentas	Carros e composições de ferramentas	11-23	
	Armários e carros para ferramentas	24-26	
	Malas vazias e complementos para carros	27-31	
Ferramenta Manual	Tabuleiros de ferramenta	33-48	
	Ferramenta de aperto	49-90	
	Alicates	91-97	
	Chaves	98-109	
	Martelos	110	
	Diversos	111-114	
	Ferramenta isolada a 1 000V	115-119	
	Ferramenta Especial Mecânica	Mecânica	121-151
Motociclos		152-154	
Chapeiro		154-158	
Pesados		159	
Acessórios		160	
Ferramenta Pneumática	Ferramenta pneumática	161-179	
	Acessórios para redes de ar comprimido	180-182	
Merchandising	Merchandising	183-187	



JONNESWAY®

Ferramentas Profissionais
• Manuais • Pneumáticas •
específicas para automóvel, motociclos e pesados





JONNESWAY®

Outros Equipamentos



Outros equipamentos

AE020009

335.00€

Bomba hidropneumática

Pressão de serviço: 690bar
 Alimentação: 7-10bar
 Dimensões: 257,50x127x204,50mm
 Peso: 8 000g
 Capacidade: 1 660cc



AE060002

570.00€

Macaco para transmissões

Altura máxima: 750mm
 Altura mínima: 200mm
 Capacidade: 1t
 Dimensões: 865x480mm
 Peso: 60kg



AE060003

1 050.00€

Macaco para transmissões

Altura máxima: 890mm
 Altura mínima: 165mm
 Capacidade: 1,5t
 Dimensões: 1 105x652mm
 Peso: 130kg



AE070002A

435.00€

Macaco de fossa

Altura máxima: 1 835mm
 Altura mínima: 1 035mm
 Capacidade: 600kg

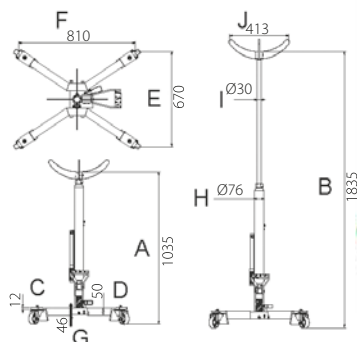

AE080001

600.00€

Macaco de fossa com prato universal

Altura máxima: 1 377mm
 Altura mínima: 880mm
 Capacidade: 500kg
 Prato: 729x597mm

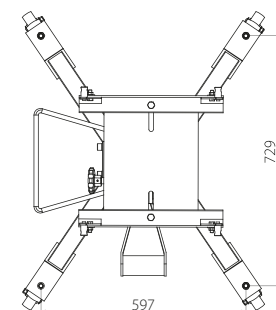
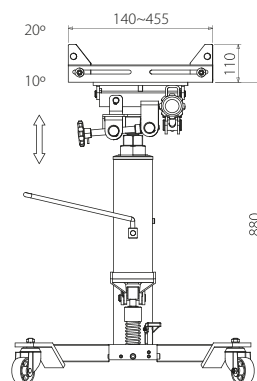
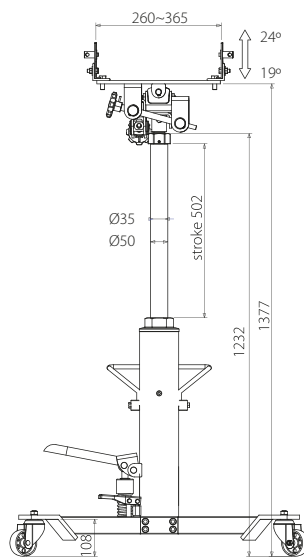

AE090025

455.00€

Macaco de rodas baixo perfil em alumínio

Altura máxima: 445mm
 Altura mínima: 87mm
 Capacidade: 2 000kg



AG010154

12.50€

Banco plástico de apoio com rodas

Dimensões: 450x335x310mm
 Peso: 1 500g



AG010219

99.00€

Banco metálico com rodas

Dimensões: 350x260x240mm
 Capacidade: 150kg

Inclui: Gaveta
 Suporte lateral para peças
 Prateleira de apoio



AG010222

73.00€

Banco metálico com rodas

Dimensões: 330x350x560mm
 Capacidade: 130kg

Inclui: Gaveta
 Suportes laterais para peças



AE090105A

50.00€

Estrado para mecânico

Dimensões: 1 000x470x130mm
 Carga admissível: 120kg



AE110020

915.00€

Macaco hidropneumático

Altura máxima: 377mm
 Altura mínima: 205mm
 Capacidade: 20t

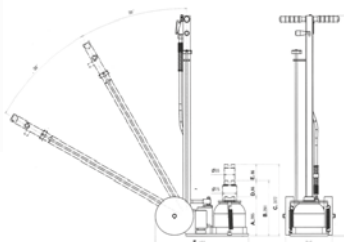

AE130003

770.00€

Grua hidráulica de 2t

Caraterísticas em mm:
 Altura mínima: 60
 Elevação máxima: 2 330
 Largura da base: 718-936
 Comprimento da base: 1 606-2 426
 Comprimento máximo braço: 1 960



AE130003-1

84.00€

Travessa

Capacidade: 500kg





AE140013

645.00€

Suporte articulado de motores

Capacidade: 600kg



AE150001

180.00€

Preguiça

Altura: 710-1 065mm

Capacidade: 12t



AE150002

150.00€

Preguiça para pesados

Altura: 456-710mm

Capacidade: 12t



AE170002

123.00€

Travessa para suporte de motores

Ajuste: 530-1 480mm



AE010025A

285.00€

Jogo prensa de chapreiro de 4t

Composição:

Bomba hidráulica manual

Cilindro hidráulico: 4t (369-522mm)

Pinça de alargamento

Adaptadores

Extensões

Mala com rodas



AE010015A

460.00€

Jogo prensa de chapreiro de 10t

Composição:

Bomba hidráulica manual

Cilindro hidráulico: 10t (369-522mm)

Pinça de alargamento

Adaptadores

Extensões

Mala com rodas



AE050003

143.00€

Macaco chapreiro 5t

Capacidade: 5t

Comprimento: 750mm

Curso pistão: 160mm



AE180001

175.00€

Travessa para portas

Comprimento: 74-115mm



AE200003

1 025.00€

Elevador para rodas veículos pesados

Capacidade: 600kg
Elevação: 395 mm



AE300025

280.00€

Aspirador de óleo

Com bomba pneumática, sondas de aspiração e indicador do nível do óleo.

Capacidade: 16l
Peso: 9 kg
Dimensões: 310x330x1 020mm



AE300149

138.00€

Aparadeira de óleo

Aparadeira regulável em altura em polietileno de alta densidade com descarga por gravidade.

Capacidade: 50l
Peso: 12kg
Dimensões: 550x550x990~1 070 mm



AR020016

81.00€

Multímetro digital e analisador automóvel

Funções: RPM, dwell, volts AC/DC, amps DC, resistências, ciclo de trabalho, temperatura, testes díodos e teste continuidade.



AR020060

199.00€

Pinça amperimétrica

De acordo com a norma IEC 1010 CAT III 1 000V

Multímetro digital com escalas automáticas
Multifunções para AC/DV amp; AC/DC V e Ohms
Capacitância, frequência e díodos
Proteção de sobrecarga

Memória
RMS (valor eficaz)

Pinça amperimétrica: 2 000A - AC/DC
Gama medição: 2 000 A AC/400A DC



AR020061

150.00€

Multímetro digital

De acordo com a norma IEC 1010 CAT III 1 000V

Mostrador de grande dimensão
Escalas automáticas AC/DC para voltagem, amperagem, capacitância, frequência e resistência
Leitura até 10 Amp com proteção e impedância alta para leituras de mV
Memória
RMS (valor eficaz)



AR030067

34.00€

Medidor de voltagem multifuncional

Pilhas não incluídas

Leitura de corrente AC/DC: 12-690V
Mostrador LED/LCD



Outros equipamentos



C-T4A

455.00€

Bancada de trabalho cinzenta com 3 gavetas

Tampo metálico com cobertura em acrílico

Medidas:

Altura: 800mm

Profundidade: 700mm

Largura: 1 525mm



C-T5G-DP

93.00€

Painel traseiro cinzento para bancada

Aplicação:

Bancada: C-T4A

Medidas:

Altura: 700mm

Largura: 1 525mm

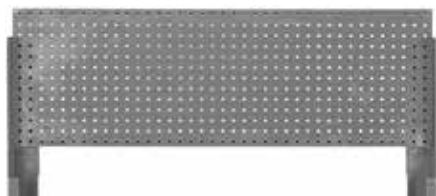

C-DBU1

1.30€

Gancho para painel traseiro de bancada

Aplicação:

Painel: C-T5G-DP

Armários: C-SA

Comprimento: 25,4mm



C-DBU7

1.70€

Gancho para painel perfurado

Aplicação:

Painel: C-T5G-DP

Armários: C-SA

Comprimento: 50,8mm

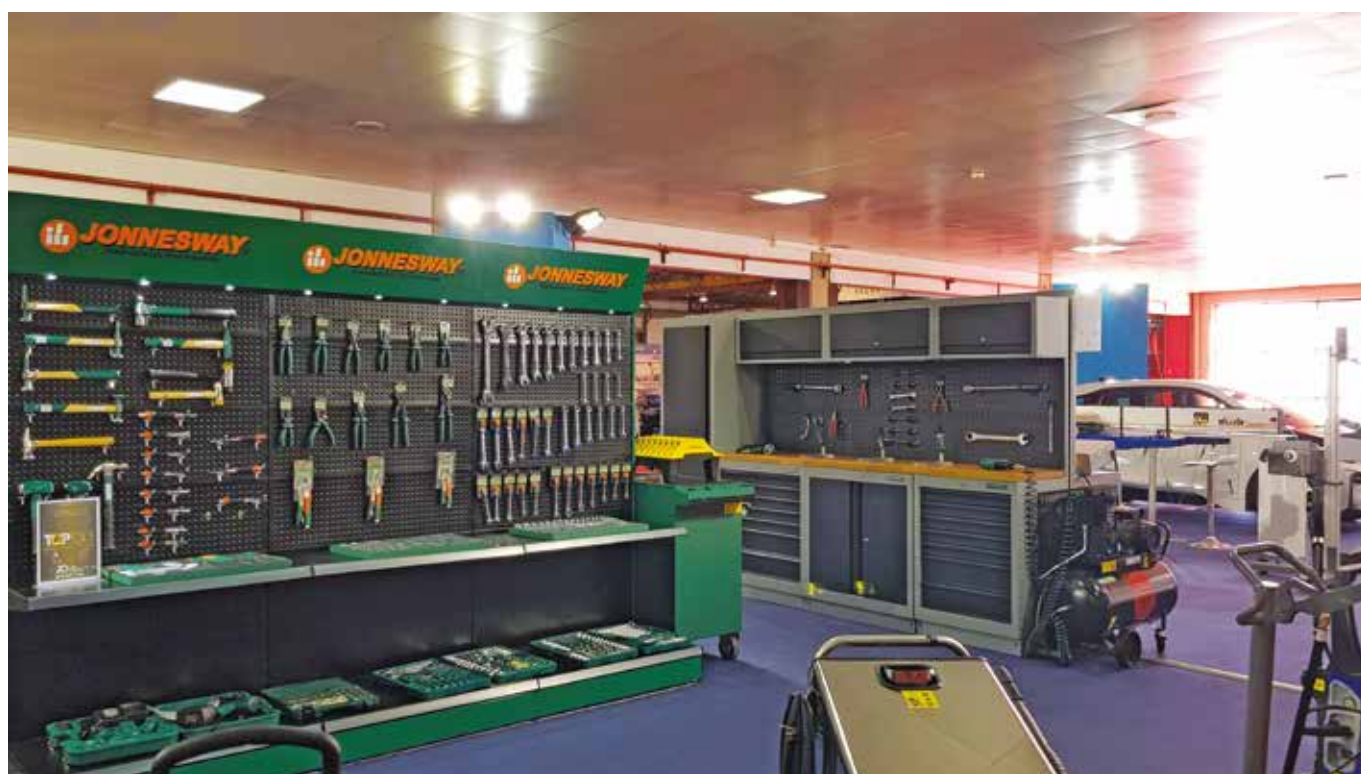



JONNESWAY[®]

Carros e Composições de Ferramentas



**Carros e
composições
de ferramentas**

**Malas vazias
e acessórios
para carros**



**Armários e
carros para
ferramentas**

As suas necessidades ...



... a nossa solução!

Desenvolvemos soluções exclusivas para si!

EVA POWER

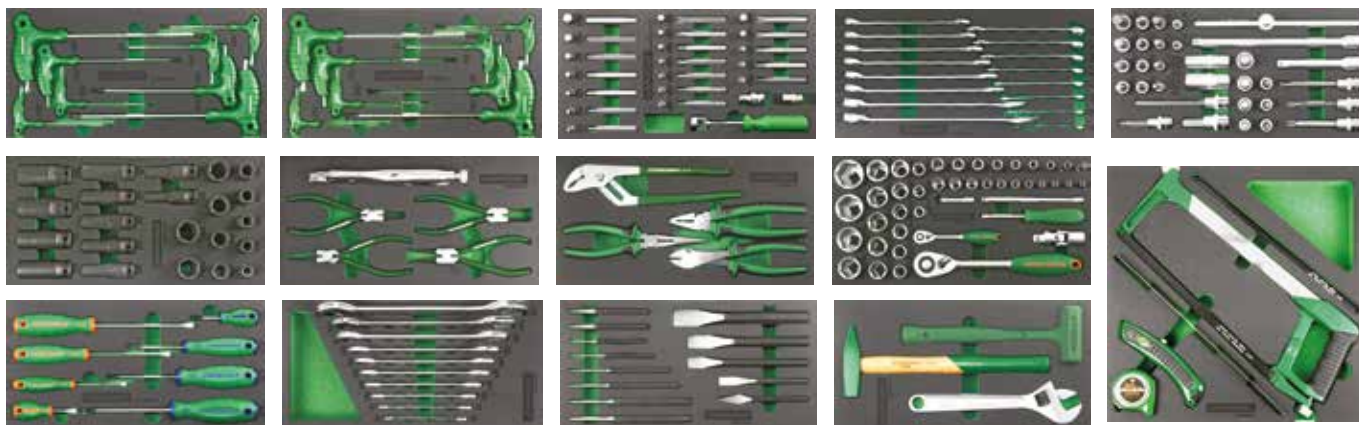
 Carro com composição de ferramentas em **Tabuleiros EVA**
TABULEIROS

Composição:

S04H4144KV Jogo de chaves de caixa com roquete de 1/2" e 1/4" com 44 peças
S04H2132KV Jogo de chaves de vela, extensões e bits com 32 peças
W26116KV Jogo de chaves mistas com 16 peças
S03A4122KV Jogo de chaves de impacto de 1/2" com 22 peças
M63113KV Jogo de punções, saca troços e talhadeiras com 13 peças
D71PP08KV Jogo de chaves de fenda/ phillips com 8 peças
W25110KV Jogo de chaves de bocas com 10 peças

P011804KV Jogo de alicates com 4 peças
S29H4141KV Jogo com chave de travões e bits com 41 peças
H10MB08KV Jogo de chaves hexagonais de punho com 8 peças
H10MT08KV Jogo de chaves torx de punho com 8 peças
M09103KV Jogo de martelos com 3 peças
P32M105KV Jogo de alicates de freios com 5 peças
MHS08KV Jogo com serra, régua, x-ato e fita métrica

CARROS



C-6DWB1



C-7DB2B



EVA POWER-V	Cor: verde 	1 515.00€
EVA POWER-C	Cor: cinza 	1 515.00€

EVA POWER BLACK	Cor: preto 	1 350.00€
EVA POWER GREEN	Cor: verde 	1 350.00€

MEC SOLUTION

Carro de ferramentas com composição flexível, ajustável às suas necessidades

Adicione **3 TABULEIROS EVA**, sendo **1 do TIPO A** e **2 do TIPO B** e finalmente escolha o carro que vá de encontro das suas necessidades

TABULEIROS TIPO

A



S04H42165SV

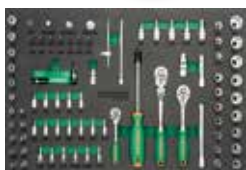

S04H3194SV

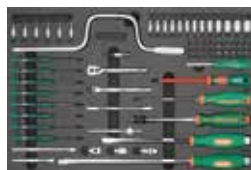

S04H2184SV

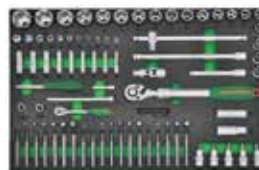

S04H4295SV



S04H46121SV

TABULEIROS TIPO

B

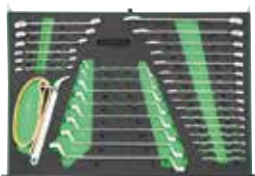

W2623431SV



D737128SV



H10121SV



D737134SV



P82736SV



P82714SV



W23559SV

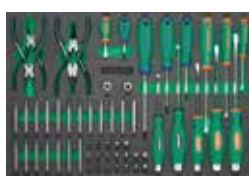

D71157SV



W26134SV

A



B



B



CARRO

CARROS

CARRO



C-6DWB1



C-7DB2B



MEC SOLUTION-V	Cor: verde	1 270.00€
MEC SOLUTION-C	Cor: cinza	1 270.00€

MEC SOLUTION BLACK	Cor: preto	1 205.00€
MEC SOLUTION GREEN	Cor: verde	1 205.00€

POWER LINE

Carro com composição de ferramentas universal para mecânico auto ou técnico de manutenção industrial

TABULEIROS



Composição:

Jogo 4 alicates de freios
 Jogo 3 alicates (universal/ pontas/ corte)
 Jogo 2 martelos e cinzeis
 Jogo 8 chaves fenda/ philips
 Jogo 9 chaves macho hexagonal

Jogo 8 chaves torx dupla punho
 Jogo serra, punções e chave inglesa
 Jogo alicate pressão e alicate ajustável
 Jogo chaves caixa com roquete 1/4"
 Jogo chaves caixa com roquete 1/2"

Jogo bits caixa 1/2" e 3/8"
 Jogo bits 1/2" e 3/8"
 Jogo 10 chaves de bocas
 Jogo 16 chaves mistas
 Jogo 8 chaves luneta 75°

CARROS





C-6DWB1



C-7DB2B

MEC POWER 19V	Cor: verde		1 290.00€
MEC POWER 19C	Cor: cinza		1 290.00€

BLACK POWER 19	Cor: preto		1 125.00€
GREEN POWER 19	Cor: verde		1 125.00€

MEC PROF-20

Carro de ferramentas para mecânico

TABULEIROS



Composição: 271 peças

Tabuleiro com

Jogo chaves de caixa longa 1/4" e 1/2" de 6 a 27mm
 Jogo chaves de caixa 1/4", 1/2" e 3/4" de 6 a 36mm
 Jogo extensões de 1/4", 1/2" e 3/4"
 Adaptadores
 Cardans
 Jogo chaves de caixa torx de 1/4" e 1/2" de E5 a E 24

Tabuleiro com

Jogo chaves luneta de 10 a 22mm
 Jogo alicates de pontas pequenos
 Jogo de chaves de hexagonais curtas
 Apalpa folgas
 Martelo pena esférica
 Chave inglesa

Tabuleiro com

Jogo chaves mistas de 6 a 34mm

Tabuleiro com

Jogo chaves fenda, Philips e torx com punho
 Chave de caixa com punho

Tabuleiro com

Jogo alicates longos, universal, pontas, corte, pressão, ajustável
 Chave de filtros

Tabuleiro com

Jogo de roquetes 1/4", 3/4", 1/2", 3/8"
 Roquete extensível de 1/2"
 Jogo bits curtos e longos 1/2"
 Jogo chaves de caixa torx de 1/2"
 Jogo chaves ribe de 1/2"
 Jogo chaves estriadas de 1/2"
 Jogo de chaves de hexagonais 1/2"

CARROS



C-6DWB1



C-7DB2B



MEC PROF20-V	Cor: verde	1 800.00€
MEC PROF20-C	Cor: cinza	1 800.00€

MEC PROF20-BLACK	Cor: preto	1 635.00€
MEC PROF20-GREEN	Cor: verde	1 635.00€

ELECTR. 1000volts

Carro de electricista com composição de ferramenta isolada a 1 000volts

TABULEIROS

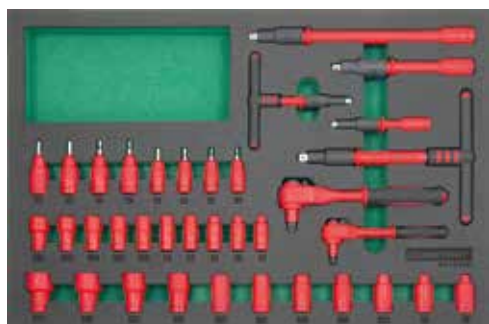
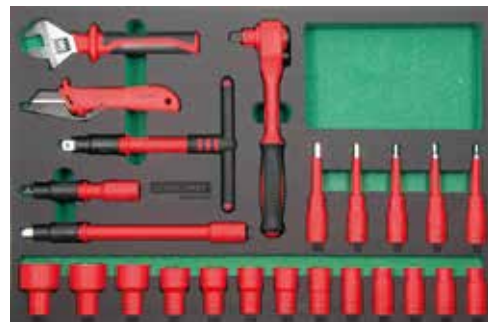
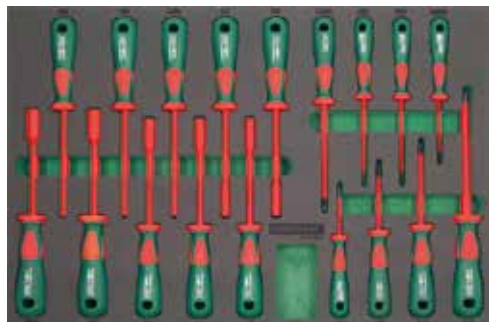

Composição:

Tabuleiro com 18 chaves isoladas

- 4 Chaves de fenda
- 4 Chaves phillips
- 10 Chaves de caixa de punho

Tabuleiro com 36 peças 1/4" e 3/8"

- 2 Roquete 1/4" e 3/8"
- 2 Cabo T de 1/4" e 3/8"
- 1 Extensão 100mm de 1/4"
- 10 Chaves de caixa 1/4"
- 4 Bits de caixa 1/4"
- 2 Extensões 3/8"
- 11 Chaves de caixa 3/8"
- 4 Bits de caixa 3/8"

Tabuleiro com 24 peças 1/2"

- 1 Roquete
- 1 Cabo T
- 2 Extensões
- 13 Chaves de caixa
- 5 Bits de caixa
- 1 Chave inglesa
- 1 X-ato

Tabuleiro com 25 peças

- 9 Chaves de bocas
- 13 Chaves de luneta
- 1 Alicate universal
- 1 Alicate de corte
- 1 Alicate de pontas

CARROS





C-6DWB1



C-7DB2B

ELECTR. 1000-V	Cor: verde		2 000.00€
ELECTR. 1000-C	Cor: cinza		2 000.00€

ELECTR. 1000 BLACK	Cor: preto		1 835.00€
ELECTR. 1000 GREEN	Cor: verde		1 835.00€

HV 1000V

Carro de ferramentas para eletricitista com composição de ferramenta isolada a 1000volts

TABULEIROS



Composição: 43 peças

Tabuleiro com

- Jogo de alicate de pontas, universal e de corte
- Jogo chaves fenda e Philips
- Jogo chaves de caixa com punho
- Busca polos



Tabuleiro com

- Multímetro digital
- Jogo de extensões
- Roquete
- Navalha
- Jogo chaves de caixa 1/2" de 8 a 22mm
- Jogo chaves luneta de 8 a 14mm
- Jogo chaves bocas de 8 a 14mm
- Jogo chaves hexagonais de 4 a 8mm
- Chave ajustável

CARROS



C-6DWB1



C-7DB2B



HV1000V-V	Cor: verde	1 385.00€
HV1000V-C	Cor: cinza	1 385.00€

HV1000V-BLACK	Cor: preto	1 220.00€
HV1000V-GREEN	Cor: verde	1 220.00€

ELECTR

Carro de ferramentas para eletricista, composição geral

TABULEIROS



Composição: 144 peças

Tabuleiro com

Jogo alicates universal, de pontas, de corte
Mini alicates
Alicate de descarnar
Alicate de cravar terminais

Tabuleiro com

Jogo chaves mistas de 10 a 22mm,
Jogo chaves de precisão
Chaves fenda e Philips

Tabuleiro com

Jogo de bits com adaptadores
Jogo chaves de boca perfil fino de 10 a 19mm
Jogo chaves caixa 1/2" de 17 a 30mm
Jogo chaves de caixa 3/8" de 11 a 16mm
Jogo de roquetes e extensões

Tabuleiro com

Bandeja magnética
Gambiarras leds
Multímetro digital
X-acto
Tesoura
Raspador com lâminas





C-6DWB5



C-7DB2B



ELECTR-V	Cor: verde 	1 500.00€
ELECTR-C	Cor: cinza 	1 500.00€

ELECTR-BLACK	Cor: preto 	1 325.00€
ELECTR-GREEN	Cor: verde 	1 325.00€

CHAPEIRO 20

Carro de ferramentas para chapeiro



TABULEIROS



Composição: 55 peças

Tabuleiro com

Lima de chapeiro
Jogo de martelos chapeiro
Chaves cavilhas

Tabuleiro com

Jogo alicates universal, de pontas e de corte
Desandador de percussão
Jogo alicates de pressão

Tabuleiro com

Jogo de ventosas
Jogo chaves fenda e Philips de pancada
Jogo de ferramentas para remoção de frisos plásticos

Tabuleiro com

Jogo encontradores para ferro
Kit remoção de vidros para brisas



C-4DWA1



C-7DB2B



CHAPEIRO20-V	Cor: verde		1 315.00€
CHAPEIRO20-C	Cor: cinza		1 315.00€

CHAPEIRO20- BLACK	Cor: preto		1 260.00€
CHAPEIRO20-GREEN	Cor: verde		1 260.00€

CHAPEIRO ALU

Carro de ferramentas para chapeiro

TABULEIROS



Composição: 56 peças

Tabuleiro com

Lima de chapeiro
Jogo de martelos chapeiro
Chaves cavilhas

Tabuleiro com

Jogo alicates universal, de pontas e de corte
Desandador de percussão
Jogo alicates de pressão

Tabuleiro com

Jogo de ventosas
Jogo chaves fenda e Philips de pancada
Jogo de ferramentas para remoção de frisos plásticos

Tabuleiro com

Jogo encontradores para alumínio
Kit remoção de vidros para brisas





C-4DWA1



C-7DB2B



CHAPEIROALU-V	Cor: verde		1 350.00€
CHAPEIROALU-C	Cor: cinza		1 350.00€

CHAPEIROALU-BLACK	Cor: preto		1 295.00€
CHAPEIROALU-GREEN	Cor: verde		1 295.00€

PINTOR20



TABULEIROS



Composição: 55 peças

Tabuleiro com

Jogo de espátulas remoção de frisos
Espelho auxiliar de reparação de
mossas
Jogo chaves para remoção de
cavilhas e molas

Tabuleiro com

Pistola pintura
Base para lixa
Jogo de 4 espátula
Lixadora orbital
Saca terminais de cabo de baterias

Tabuleiro com

Jogo chaves luneta de 6 a 32mm,
X-acto
Jogo chaves fenda e Philips

Tabuleiro com

Jogo de 6 ventosas e acessórios



C-4DWA1



C-7DB2B

PINTOR20-V	Cor: verde		1 330.00€
PINTOR20-C	Cor: cinza		1 330.00€

PINTOR20-BLACK	Cor: preto		1 275.00€
PINTOR20-GREEN	Cor: verde		1 275.00€

MEC PESADOS

Carro de ferramentas com 7 gavetas
+ pega + bloco complementar

TABULEIROS



MEC PESADOS 20A

2 760.00€



MEC PESADOS 20B

2 605.00€



Composição: 162 peças

Tabuleiro com

Jogo chaves caixa de 1/2" de 8 a 34mm com roquete e extensão
Jogo chaves torx macho 1/2" de T30 a T80
Jogo chaves macho hexagonais de 1/2" de H5 a H19
Cardan
Rabo de força

Tabuleiro com

Jogo chaves caixa de impacto longas de 1/2" e 3/4" de 10 a 46mm
Adaptadores
Extensão
Cardan

Tabuleiro com

Jogo de martelos, marreta e alicates

Tabuleiro com

Jogo chaves fenda e Philips de pancada
Jogo chaves Hexagonais de impacto, chave de filtro

Tabuleiro com

Jogo chaves luneta de 6 a 32mm e Jogo chaves de bocas de 6 a 32mm

Tabuleiro com

Jogo chaves de 3/4" de 19 a 50mm com extensões, adaptadores, cardan e roquete

Tabuleiro com

Jogo chaves mistas de 20 a 46mm

C-SA2

3 700.00€

Armário modular

- Dimensões totais: 2 322x1 980x526mm
- 1 Módulo de armário vertical: 600x526x1980mm
- 1 Módulo 6 gavetas: 861x500x994mm
- 1 Módulo 2 portas: 861x500x994mm
- 2 Armários superiores: 861x300x338mm
- 2 Painéis perfurados: 861x20x338mm
- 1 Tampo madeira: 1 725x480x40mm



C-SA2S

3 620.00€

Armário modular

- Dimensões totais: 2 322x526x1 980mm
- 1 Módulo de armário vertical: 600x526x1 980mm
- 1 Módulo 6 gavetas: 861x500x994mm
- 1 Módulo 2 portas: 861x500x994mm
- 2 Armários superiores: 861x300x338mm
- 2 Painéis perfurados: 861x20x338mm
- 1 Tampo inox: 1 725x480x40mm



C-SA3

4 850.00€

Armário modular

- Dimensões totais: 2 998x526x1 980mm
- 1 Módulo de armário vertical: 600x526x1 980mm
- 1 Módulo 6 gavetas: 861x500x994mm
- 1 Módulo 6 gavetas: 676x500x994mm
- 1 Módulo 2 portas: 861x500x994mm
- 1 Armário superior: 861x300x338mm
- 1 Armário superior: 676x300x338mm
- 2 Painéis perfurados: 861x20x338mm
- 1 Pannel perfurado: 676x20x338mm
- 1 Tampo madeira: 2 404x480x40mm



C-SA3S

4 770.00€

Armário modular

- Dimensões totais: 2 998x526x1 980mm
- 1 Módulo de armário vertical: 600x526x1 980mm
- 1 Módulo 6 gavetas: 861x500x994mm
- 1 Módulo 6 gavetas: 676x500x994mm
- 1 Módulo 2 portas: 861x500x994mm
- 2 Armário superior: 861x300x338mm
- 1 Armário superior: 676x300x338mm
- 2 Painéis perfurados: 861x20x338mm
- 1 Pannel perfurado: 676x20x338mm
- 1 Tampo inox: 2 404x480x40mm

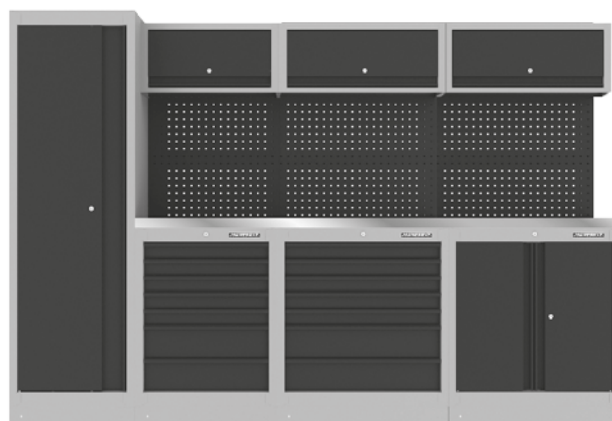

C-SA4S

4 550.00€

Armário modular

Dimensões totais: 2 998x526x1 980mm
 1 Módulo de armário vertical: 600x526x1 980mm
 1 Módulo 6 gavetas: 676x500x994mm
 1 Carrinho 7 gavetas: 671x459x940mm
 1 Módulo 2 portas: 861x500x994mm
 2 Armário superior: 861x300x338mm
 1 Armário superior: 676x300x338mm
 2 Painéis perfurados: 861x20x338mm
 1 Painel perfurado: 676x20x338mm
 1 Tampo aço inox: 2 404x480x40mm



C-SQ2401

820.00€

Armário alto para arrumos

Dimensões totais: 600x526x1 980mm
 1 Porta



C-SP3401

230.00€

Armário de topo

Dimensões totais: 861x300x338mm
 Porta basculante



C-SQ3401

799.00€

Armário largo com 7 gavetas

Dimensões totais: 861x500x994mm
 7 Gavetas



C-SQ3402

525.00€

Armário largo com 2 portas

Dimensões totais: 861x500x994mm
 2 Portas



C-SQ3403

710.00€

Armário multifunções

Dimensões totais: 861x500x994mm
 1 Alojamento para rolo de papel
 1 Divisão para o lixo
 1 Divisão para arrumos



C-S7DW1

637.00€

Carro vazio para armário oficial

Permite ser arrumado em armário oficial
 Dimensões totais: 671x459x940mm
 Peso: 52,4kg
 7 Gavetas



C-SR3401

70.00€

Conjunto de 2 painéis perfurados

Dimensões totais: 861x20x338mm

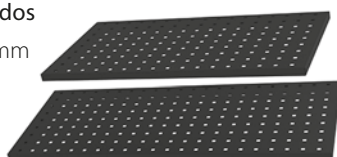

C-SU01

8.00€

Rodapé

Para armário alto.

Comprimento: 500mm

C-SU02

8.00€

Rodapé

É necessário incluir para os módulos de fecho.

Comprimento: 470mm



C-SW01

67.00€

Suporte lateral

É necessário incluir uma unidade para suporte do armário superior quando este ficar na extremidade.



C-SW02

43.00€

Suporte central para união de módulos

É necessário incluir uma unidade por cada 2 módulos.



C-SM

240.00€

Tampo de madeira para armário

Precio por metro

Dimensões totais: 1 000x480x40mm

C-SG

205.00€

Tampo em chapa galvanizada

Precio por metro

Dimensões totais: 1 000x480x40mm

C-SInox

525.00€

Tampo em aço inox liso

Precio por metro

Dimensões totais: 1 000x480x40mm



C-1DM1

285.00€

Gaveta lateral de apoio de laptop/ tablet até 14"

Adicional para carros de ferramentas

Dimensões gaveta: 410x285x70



* Exemplo de aplicação em carro de ferramentas

C-3DW5

630.00€

Carro vazio para ferramenta

Dimensões totais: 670x460x960mm

Peso: 54,2kg

3 Gavetas de 576x380x75mm

1 Arrumos com 2 portas de 603x404x478mm



C-4DWA1

Cor: verde



540.00€

C-4DWA1G

Cor: cinza



540.00€

Carro vazio para ferramenta com 4 gavetas

Tampo especial preparado para banca de trabalho

Dimensões totais: 670x460x795mm

2 Gavetas de 579x380x56mm

1 Gaveta de 579x380x123mm

1 Gaveta de 579x380x179mm



C-7DB2

Cor: verde



485.00€

C-7DB2B

Cor: preto



485.00€

Carro vazio para ferramenta com 7 gavetas

Dimensões totais: 670x460x960mm

5 Gavetas de 576x380x75mm

2 Gavetas de 576x380x154mm

Peso total: 60kg

Capacidade de carga: 40kg/roda

Dimensão rodas: 127x25,5mm



C-6DWB1

Cor: verde



650.00€

C-6DWB1G

Cor: cinza



650.00€

Carro vazio para ferramenta com 6 gavetas

Tampo especial preparado para banca de trabalho

Dimensões totais: 670x460x960mm

4 Gavetas de 579x380x56mm

1 Gaveta de 579x380x123mm

1 Gaveta de 579x380x179mm



C-6DWB5

660.00€

Carro vazio para ferramenta com 6 gavetas

Tampo revestido a plástico e suporte para ferramenta

Dimensões totais: 670x460x960mm

4 Gavetas de 579x380x56mm

1 Gaveta de 579x380x123mm

1 Gaveta de 579x380x179mm



C-7DS1

910.00€

Carro vazio para ferramenta com 7 gavetas
Tampo em aço

Dimensões totais: 710x500x967mm
1 Painel lateral perfurado
1 Painel lateral para compartimentos de arrumos
4 Rodas, 2 direcionais com travão
Peso total: 74,5kg
Capacidade de carga: 160kg/roda

* As caixas laterais são opção



C-7DW9

760.00€

Carro vazio para ferramenta com 7 gavetas
Sistema de segurança, abertura de 1 só gaveta

Dimensões totais: 670x460x960mm
5 Gavetas de 576x380x75mm
2 Gavetas de 576x380x154mm
Peso total: 74,5kg
Capacidade de carga: 75kg/roda
Dimensão rodas: 127x50,8mm



C-7 TOWER

999.00€

Carro vazio com 13 gavetas

Dimensões totais: 670x460x1 334mm
5 Gavetas de 576x380x75mm
2 Gavetas de 576x380x154mm
Caixa superior
3 Gavetas de 170x275x50mm
2 Gavetas de 569x275x50mm
1 Gaveta de 569x275x75mm



C-A16W

435.00€

Armário com 7 gavetas

Inclui 2 rodas para acoplamento aos carros C-7/ C-6

5 Gavetas de 288x380x75mm
2 Gavetas de 288x380x154mm



C-A17W

280.00€

Armário com 1 porta

Inclui 2 rodas para acoplamento aos carros C-7/ C-6



C-13DW53

1 815.00€

Carro grande vazio para ferramenta com 13 gavetas

Dimensões totais: 1 358x460x1 150mm
10 Gavetas de 576x380x75mm
2 Gavetas de 579x380x154mm
1 Gaveta de 1 216x380x173mm



C-10DW42

1 450.00€

Carro grande vazio para ferramenta com 10 gavetas

Dimensões totais: 1 070x460x981mm
1 Compartimento arrumação de 316x404x1 150mm
5 Gavetas de 288x380x75mm
2 Gavetas de 576x380x154mm
1 Gaveta de 288x380x154mm
1 Gaveta de 576x380x154mm
1 Gaveta de 928x380x173mm



C-T3

465.00€

Carro vazio para ferramenta com 3 gavetas

Tampo de abrir

Dimensões totais: 780x520x884mm



C-T12

195.00€

Carro com 3 prateleiras

Dimensões totais: 716x410x880mm

Peso: 20kg

Rodas: 4 (2 fixas+2 direcionais)



C-5CD

268.00€

Caixa metálica vazia para ferramenta com 5 malas

Dimensões totais: 431x307x381mm

5 Malas de 48x245x55mm



C-6DA4

280.00€

Caixa metálica vazia para ferramenta com 6 gavetas

Compartimento no topo com várias divisórias

Dimensões totais: 660x307x374mm

3 Gavetas de 172x270x41mm

2 Gavetas de 572x270x31mm

1 Gaveta de 572x270x65mm



Malas vazias e complementos para carros

C-6DA494

710.00€

Caixa de ferramenta com 6 gavetas - 98 peças

Compartimento no topo com várias divisórias

Dimensões totais: 660x307x374mm

Composição:

AG10002SC

D376514SC

R4811SC

P0813SC

S04H5129SC

V11011SC

W25117SC

W27AT02SC



C-3DH5

140.00€

Caixa metálica vazia para ferramenta com 3 gavetas

Compartimento no topo

Dimensões totais: 535x220x290mm

3 Gavetas de 505x195x45mm



C-3DH2

72.00€

Caixa metálica vazia para ferramenta com 5 compartimentos

Dimensões totais: 470x240x220mm



C-HA

136.00€

Mala vazia para ferramenta em tecido sintético e com pega metálica

Dimensões: 620x250x310mm



C-HA78S

515.00€

Mala para ferramenta em tecido sintético e com pega metálica - 78 peças



C-3DH262
325.00€
Caixa metálica para ferramenta com 5 compartimentos - 62 peças

Dimensões totais: 470x220x350mm

Composição

- P106 Alicates de corte
- P116 Alicates de pontas
- P087 Alicates universais
- D70 Jogo de 6 chaves fenda/ phillips
- W26 Jogo de 18 chaves mistas
- R2904 Roquete de 1/2"
- S04H41 Jogo de 18 chaves de caixa
- S15H472 Adaptador
- S24H4 Extensões
- S22H41450 Cabo articulado 450mm
- S23H41300 Cabo T correção 300mm
- S21H4150 Extensão
- S17H4121 Chave de velas 21mm
- H03SM109S Jogo de chaves hexagonais

C-A456
70.00€
Tampo plástico para carros de ferramenta

Aplicável aos carros C-4/ C-6 e C-7

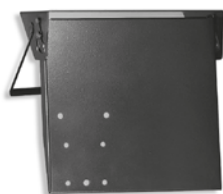
C-A9
55.00€
Base para torno e suporte para rolo de papel

C-A27
50.00€
Tampo em acrílico resistente ao impacto para carros de ferramentas

Aplicável somente aos carros C-5DW/ C-6DW e C-7DW

C-7DW1-TS
95.00€
Tampo completo para carros de ferramentas

Aplicável somente aos carros C-5DW/ C-6DW e C-7DW

Composição

- 1 Tampo acrílico resistente ao impacto
- 1 Base metálica de apoio
- 1 Revestimento EVA de 2mm

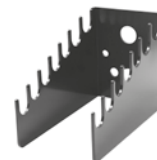
C-A31
17.50€
Suporte lateral para chaves em T para fixação

C-A3

Cor: verde

17.00€
Pega para carro de ferramenta

Aplicável a C-4DW; C-6DW e C-7DW

C-A3-B

Cor: preto

17.50€
Pega para carro de ferramenta

Aplicável a C-7DB2

C-A3G

Cor: cinza

17.50€
Pega para carro de ferramenta

Aplicável a C-4DW; C-6DW e C-7DW

C-BS

Jogo de calhas direita e esquerda, para gavetas de carros e caixas

Ref.	Aplicação	Precio
C-BS Kit1	Carros: C-4DW/ C-5DW/ C-6DW/ C-7DW	17.00€
C-BS Kit2	Caixas: C-6DA4	10.50€
C-BS Kit3	Carros: C-10DW/ C-13DW	18.00€



C-PC

Canhão de fechadura

Ref.	Aplicação	Precio
C-PC1	C-DA4	6.00€
C-PC2	C-5/ C-6/ C-7	6.80€
C-PC3	C-4	10.90€



C-WHEEL

Rodas

Ref.	Tipo	Aplicação carro	Precio
C-WHEEL1	fixa	C-6/ C-7	17.00€
C-WHEEL2	travão	C-6/ C-7	21.00€
C-WHEEL5	fixa	C-4/ C-5/ C-7DB2	15.00€
C-WHEEL6	travão	C-4/ C-5/ C-7DB2	21.00€
C-WHEEL8	fixa	C-T3/ C-/12	11.50€
C-WHEEL9	travão	C-T3/ C-/12	13.30€



Malas vazias e complementos para carros

C-A

Torno de bancada

Ref.	Tipo	Largura mordente (mm)	Precio
C-A7*	3"	76	86.00€
C-A8*	4"	101	102.00€
C-A10	5"	127	132.00€
C-A11	6"	152	160.00€
C-A12	8"	203	199.00€
C-A13	10"	254	285.00€



* Aplicável em carro de ferramenta (necessário suporte C-A9)

C-A2501S

20.00€

Conjunto de caixas plásticas para gavetas de carros de ferramenta

Composição
12 Caixas 93x93x43mm
4 Caixas 283x93x43mm

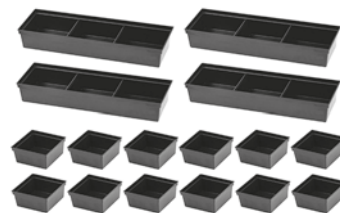

C-APB

21.50€

Conjunto de caixas plásticas para gavetas de carros de ferramenta

Composição
8 Caixas 283x93x43mm

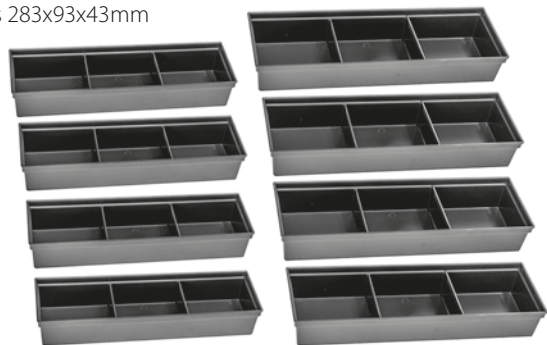



JONNESWAY®

de Profissionais para Profissionais

VDE Prüf- und Zertifizierungsinstitut

ZEICHENGENEHMIGUNG MARKS APPROVAL

Jonnesway Enterprise
Co. Ltd.
6F-9, No.51, Sec.2, Keelung Rd.
110 TAIPEI
TAIWAN

ist berechtigt, für ihr Produkt /
is authorized to use for their product
Zusammensetzbares Werkzeug
Assembly tool

die hier abgebildeten markenrechtlich geschützten Zeichen
für die ab Blatt 2 aufgeführten Typen zu benutzen /
the legally protected Marks as shown below for the types referred to on page 2 ff.



Geprüft und zertifiziert nach /
Tested and certified according to

DIN EN 60900 (VDE 0682-2011):2013-04; EN 60900:2012

Das Produkt entspricht den Anforderungen des deutschen Produktsicherheitsgesetzes (ProdSG)
hinsichtlich der Gewährleistung von Sicherheit und Gesundheit.
The product covers the requirements of the German Act "Produktsicherheitsgesetz (ProdSG)"
regarding the ensurance of safety and health.

Befristet zum / valid until: 2020-04-30

VDE Prüf- und Zertifizierungsinstitut GmbH
VDE Testing and Certification Institute
Zertifizierungsstelle / Certification

Aktenzeichen: 5010169-3940-0019 / 223207

File ref.: Ausweis-Nr. 40035283

Certificate No. Weitere Bedingungen siehe Rückseite und Folgebblätter /
Further conditions see reverse and following pages

Offenbach, 2012-06-26

(letzte Änderung / updated 2016-06-20)

VDE Zertifikate sind nur gültig bei Veröffentlichung unter:
VDE certificates are valid only when published on:

<http://www.vde.com/zertifikat>
<http://www.vde.com/certificate>



VDE Prüf- und Zertifizierungsinstitut

ZEICHENGENEHMIGUNG MARKS APPROVAL

Jonnesway Enterprise
Co. Ltd.
6F-9, No.51, Sec.2, Keelung Rd.
110 TAIPEI
TAIWAN

ist berechtigt, für ihr Produkt /
is authorized to use for their product

Kabelmesser
Cable knives

die hier abgebildeten markenrechtlich geschützten Zeichen
für die ab Blatt 2 aufgeführten Typen zu benutzen /
the legally protected Marks as shown below for the types referred to on page 2 ff.



Geprüft und zertifiziert nach /
Tested and certified according to

DIN EN 60900 (VDE 0682-2011):2013-04; EN 60900:2012

Das Produkt entspricht den Anforderungen des deutschen Produktsicherheitsgesetzes (ProdSG)
hinsichtlich der Gewährleistung von Sicherheit und Gesundheit.
The product covers the requirements of the German Act "Produktsicherheitsgesetz (ProdSG)"
regarding the ensurance of safety and health.

Befristet zum / valid until: 2020-02-29

VDE Prüf- und Zertifizierungsinstitut GmbH
VDE Testing and Certification Institute
Zertifizierungsstelle / Certification

A. Fabian

A. Fabian
VDE Zertifikate sind nur gültig bei Veröffentlichung unter:
VDE certificates are valid only when published on:

Aktenzeichen: 5010169-3940-0010 / 223208

File ref.:

Ausweis-Nr. 40035280

Certificate No. **Blatt 1**
Page

Weitere Bedingungen siehe Rückseite und Folgebblätter /
Further conditions see reverse and following pages

Offenbach, 2012-06-26

(letzte Änderung / updated 2016-05-25)

<http://www.vde.com/zertifikat>
<http://www.vde.com/certificate>





JONNESWAY®

Ferramenta Manual



Tabuleiros para
composição
de carros



Chaves



Ferramenta
de aperto



Martelos



Alicates



Diversos

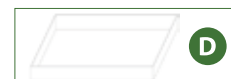

AG010002SP

47.00€

Jogo de 4 alicates de freios

Composição:

- AG010002 Alicete de freios interiores
- AG010005 Alicete de freios interiores de ponta curva
- AG010008 Alicete de freios exteriores
- AG010011 Alicete de freios exteriores de pontas curvas 90°

A



AG010026SP

50.00€

Jogo de martelos e talhadeiras

Composição:

- M09300 Martelo tipo alemão 300g
- M11035 Martelo com batentes de borracha 400g
- M61 Jogo de 3 talhadeiras

A



AG010150SC

97.00€

Jogo de 8 alicates de freios

Composição:

- 4 Alicete de pontas direitas
- 4 Alicete de pontas curvas

B



AG10001SP

105.00€

Jogo de machos e caçonetes

Composição:

- 17 Machos manuais: M3 a M12
- 17 Caçonetes: M3 a M12
- 1 Porta caçoneto
- 1 Desandador de machos
- 1 Punho desandador

B



AI10001SP

185.00€

Jogo de ferramentas para substituição de válvulas da cabeça do motor

Composição:

- AN010064 Compressor de válvulas da cabeça do motor
- AI020056 Alicete para vedantes de válvulas
- AI020099 Adaptador de mola de válvula
- AI020100 Suporte de válvulas
- AI010012A Removedor de pastilhas de válvula

B



AI10002SP

149.00€

Jogo de ferramentas para substituição da polie da correia da cambota

Composição:

- AE310030 Saca de 2 pernas
- AE10035-1 Complemento para 3 pernas
- AN010038 Saca vedante
- AI020087A Saca polie da cambota

B



A110003SP

119.00€

Jogo de chaves de copo para filtros

Composição:

- 9 Chaves de copo para filtros
- 14 Chaves para bujão do carter
- 1 Chave de filtros

B

Description		
○ 8mm	BMW Ford	△ 10mm Renault
○ 9mm	General Motor	T-Bar To Drive
○ 10mm	Ford	30-160mm Oil Filter Chain 3/8" Oil
○ 12mm	Fiat, Lancia Peugeot	Filter Cap Wrench
○ 14mm	Mercedes Lancia	93mm-15 GM, Nissan, Volvo, Mazda, Audi, VW, etc.
○ 17mm	BMW Austin, Audi, VW	76mm-14 VW, Porsche, Mercedes, BMW, Toyota
○ 3/8"	General Motor	75,6mm-14 Mazda, General Motor
□ 10mm	BMW, Renault, Toyota	38mm etc Diesel Engine
□ 8mm	Citroen, Peugeot, Renault, Talbot, Volvo	36mm Benz, VW, BMW/M52, M60, M73
□ 11mm	Ford	32mm GM, Saab, Saturn
□ 13mm	Nissan, Subaru	30mm General Motor
□ 3/8"	Honda, Mazda, Renault, Saab, Volvo	27mm Mercedes
□ 7mm	General Motor	24mm BMW/ 5 & 7 séries

AN100002SP

184.00€

Jogo de 42 peças de ferramenta para travões

Este tabuleiro ocupa meia gaveta do carro de ferramentas.

C

D70105SP

35.00€

Jogo de 5 chaves fenda/ phillips impacto

Composição/ medidas em mm:

- | | | | |
|-------------|--------------------|-------------|--------------------|
| D70S | 3 Chaves de fenda: | D70P | 2 Chaves phillips: |
| | 6,5x125 | | PH 2x100 |
| | 8x150 | | PH 3x150 |
| | 9,5x175 | | |

A

D71PP08SP

32.50€

Jogo de 8 chaves fenda/ phillips

Composição/ medidas em mm:

- | | | | |
|-------------|--------------------|-------------|--------------------|
| D71S | 4 Chaves de fenda: | D71P | 4 Chaves phillips: |
| | 6,5x38 | | 2x38 |
| | 4x80 | | 1x80 |
| | 5,5x125 | | 2x100 |
| | 6,5x150 | | 3x150 |

A

D725N08SP

69.00€

Jogo de 8 chaves de caixa de punho

Composição:

- Chaves de 6 a 13mm

C

H10MB08SP

39.00€

Jogo de 8 chaves macho hexagonal com extremidade esférica e punho

Composição/ medidas em mm:

- | | | |
|--------------|---------|--------|
| H10MB | 2x100 | 5x150 |
| | 2,5x100 | 6X150 |
| | 3x100 | 8X200 |
| | 4x100 | 10X200 |

B

H10MT08SP

38.00€

Jogo de 8 chaves torx duplas tamperproof com punho

Composição/ medidas em mm:

- | | | |
|--------------|---------|---------|
| H10MT | T10x100 | T27x150 |
| | T15x100 | T30X150 |
| | T20x100 | T45X200 |
| | T25x100 | T50X200 |

B

H20MT08SP

40.80€

Jogo de 8 chaves torx duplas de punho

Composição/ medidas em mm:

- | | | |
|--|---------|---------|
| | T10x110 | T27x145 |
| | T15x120 | T30X155 |
| | T20x125 | T45X185 |
| | T25x135 | T50X205 |

B

M09513SP 73.00€

Jogo de martelos e punções

Composição:

- M07016 Martelo com batentes de plástico
- M09500 Martelo de mecânico tipo "alemão"
- M63M106S Jogo saca troços cromados
- M64M105S Jogo punções e escopros cromados

A



M645114SP 74.00€

Jogo de serra, chave inglesa, punções e escopros

Composição:

- M63 6 Punções
- M64 4 Escopros
- W27AS10 Chave inglesa
- MHS100AG Serra

B



MTC101SP 199.00€

Jogo de ferramenta de medição

Composição/ medidas em mm:

- Paquímetro digital 150
- Esquadro metálico 300
- Régua metálica 300
- Compasso 200
- Micrómetro 0-25
- Micrómetro 25-50
- Lapiseira

B



P018SP1 54.50€

Jogo de 3 alicates e 7 chaves hexagonais

Composição:

- P018 Alicates universal
- P038 Alicates de corte diagonal
- P068 Alicates de pontas
- H01SM109S Chaves hexagonais

A



P018SP 47.00€

Jogo de 3 alicates

Composição:

- P018 Alicates universal
- P038 Alicates de corte diagonal
- P068 Alicates de pontas

A



P04704SP 54.50€

Jogo de 4 alicates de corte

Não utilizar em metal.

A



P0803SP 43.00€

Jogo de 3 alicates isolados

Composição:

- P087 Alicates universal
- P097 Alicates de corte diagonal
- P118 Alicates de pontas

A



P0903SP 52.50€

Jogo de 3 alicates isolados

Composição:

- P0118 Alicates universal
- P0918 Alicates de corte diagonal
- P1118 Alicates de pontas

A



P2710SP 31.50€

Jogo de 2 alicates

Composição:

- P2710 Alicates ajustável
- P32M10A Alicates de pressão

A



P2803SP

50.00€

Jogo de 2 alicates e chave inglesa

Composição:

W27AS10 Chave inglesa
P2810 Alicates ajustável
P32M10A Alicates de pressão

A

S03A4122SP

79.50€

Jogo de 22 chaves de impacto 1/2"

Composição/ medidas em mm:

S03A4 Chaves: 10; 11; 12; 13; 14; 16; 17; 19; 21; 22 e 24
S03AD4 Chaves: 10; 11; 12; 13; 14; 16; 17; 19; 21; 22 e 24

A

S04H2125SP

46.90€

Jogo de chaves de caixa com 24 peças de 1/4"

Composição/ medidas em mm:

R3702 Roquete de 48 dentes
S04H2 Chaves de caixa: 4; 5; 5,5; 6; 7; 8; 9; 10; 11; 12 e 13
S04HD2 Chaves de caixa: 5; 6; 7; 8; 9; 10; 11; 12 e 13
S24H250 Extensão 50
S24H2150 Extensão 150
S26H2150 Punho

A

S04H3157SP

121.00€

Jogo de 8 chaves de caixa com 56 peças de 1/4" e 3/8"

Composição/ medidas em mm:

R3702 Roquete 1/4" de 48 dentes
S04H2 Chaves 1/4": 4; 4,5; 5; 5,5; 6; 7; 8; 9; 10; 11; 12 e 13
S04HD2 Chaves 1/4": 8; 10; 12 e 13
S09H2 Bits hexagonais: 3; 4; 5 e 6
S11H2 Bits torx: T10; T15; T20; T25; T27 e T30
 Bits fendas: 4; 5,5 e 7
 Bits phillips: PH1; PH2 e PH3
S24H2 Extensões
 Adaptador de extensão
S16H302 Adaptador universal
 Punho
R3703 Roquete 3/8" de 48 dentes
S04H3 Chaves 3/8": 14; 15; 17; 18; 19; 20; 22 e 24
S04HD3 Chaves 3/8": 14; 15 e 17
S17H3 Chaves de velas: 16 e 21
S24H3 Extensões
 Adaptador extensão 3/8" - 1/2"
S15H356 Adaptador universal

B

S04H3536SP

91.00€

Jogo de chaves de caixa e chaves mistas com 36 peças de 3/8"

Composição/ medidas em mm:

R3403 Roquete de 72 dentes
S04H3 Chaves de caixa: 6 a 22
S24H3 Extensões
 Adaptador de extensão 1/2" - 3/8"
S17H3 Chaves de velas: 16 e 21
S15H356 Adaptador universal
W26 Chaves mistas boca/ luneta: 7 a 17

B

S04H4125SP

85.00€

Jogo de chaves de caixa com 25 peças de 1/2"

Composição/ medidas em mm:

R3704 Roquete de 48 dentes
S04H4 Chaves: 10; 11; 12; 13; 14; 15; 16; 17; 18; 19; 20; 21; 22; 23; 24; 27; 30 e 32
S24H4 Extensões
S17H4 Chaves de velas: 16 e 21
S23H4125 Cabo "T" correção
S15H472 Adaptador universal

B

S04H4131SP

125.00€

Jogo de chaves e roquete com 31 peças de 1/2"

Composição/ medidas em mm:

- Roquete de 72 dentes
- Chaves de caixa: 10 a 32
- Chaves de velas: 16 e 21
- Cardan
- Extensão de 125
- Extensão de 250
- Cabo "T" corrediço de 250
- Bits hexagonais de 5; 6; 8; 10 e 12

C



S04H4524SP

98.00€

Jogo de chaves sextavadas com 24 peças de 1/2"

Composição/ medidas em mm:

- R3704 Roquete de 48 dentes
- S04H4 Chaves: 10; 11; 12; 13; 14; 15; 16; 17; 18; 19; 20; 21; 22; 23; 24; 27; 30 e 32
- S24H4 Extensões 5" e 10"
- S15H472 Adaptador universal
- S22H41375 Punho flexível 15"
- S23H41300 Cabo "T" corrediço

B



S04H4726SP

105.00€

Jogo de chaves de caixa com 26 peças de 1/2"

Composição/ medidas em mm:

- R3704 Roquete de 48 dentes
- S04H4 Chaves de caixa: 12; 13; 14; 15; 16; 17; 18; 19; 20; 21; 22; 23; 24; 25; 26; 27; 28; 30 e 34
- S24H4 Extensões 5" e 10"
- S17H4116 Chave de velas 16
- S15H472 Adaptador universal
- S23H41300 Cabo "T" corrediço
- S41H4 Manivela de punho metálico

B



S04H4728SP

97.00€

Jogo de chaves de caixa sextavadas com 28 peças de 1/2"

Composição/ medidas em mm:

- R3704 Roquete de 48 dentes
- S04H4 Chaves de caixa: 8; 9; 10; 11; 12; 13; 14; 15; 16; 17; 18; 19; 20; 21; 22; 23; 24; 25; 26; 27; 28; 30; 32 e 34
- S24H4250 Extensão 10"
- S15H472 Adaptador universal
- S23H41300 Cabo "T" corrediço

B



S06H427SP

79.00€

Jogo de chaves de caixa bits com 27 peças de 1/2" e 3/8"

Composição:

- S09H4 Bits hexagonais de 1/2"
- S49H4 Bits estriados de 1/2"
- S09H3 Bits hexagonais de 3/8"

A



S09H4118SP

58.50€

Jogo de chaves de caixa bits hexagonais com 18 peças de 1/2"

Composição:

- Chaves 55mm: H5; H6; H7; H8; H10; H12; H14; H17 e H19
- Chaves 100mm: H5; H6; H7; H8; H10; H12; H14; H17 e H19

A

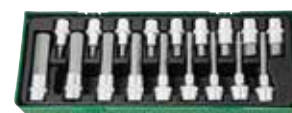

S29H4140SP

41.50€

Jogo 40 bits de 3/8" para quadra de 1/2" e 3/8"

Composição:

- Bits hexagonais
- Bits torx
- Bits estriados
- Porta bits

A



V1310SP 137.00€

Jogo de alicates de cravar e descarnar

Composição:

V1310 Alicates de cravar terminais isolados e não isolados

V1401 Alicates de descarnar fios

AG010031A Pesca magnético com espelho

Teste para circuitos

Kit com 60 terminais

B



W23108SP 52.50€

Jogo de 8 chaves de luneta 75°

Composição/ medidas em mm:

W23 Chaves: 6x7; 8x9; 10x11; 12x13; 14x15; 16x17; 18x19 e 20x22

A



W24A109SP 130.00€

Jogo de 9 chaves de luneta aberta flexível

Composição/ medidas em mm:

W24A Chaves: 8x8; 10x10; 11x11; 12x12; 13x13; 14x14; 17x17; 19x19 e 22x22

A



W25110SP 51.50€

Jogo de 10 chaves de bocas

Composição/ medidas em mm:

W25 Chaves: 6x7; 8x9; 10x11; 12x13; 14x15; 16x17; 18x19; 21x23; 24x27 e 30x32

A

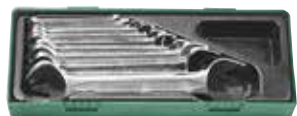

W26112SP 49.00€

Jogo de 12 chaves mistas de boca/ luneta

Composição/ medidas em mm:

W26 Chaves: 8; 9; 10; 11; 12; 13; 14; 15; 16; 17; 19 e 22

A



W26116SP 64.00€

Jogo de 16 chaves mistas de boca/ luneta

Composição/ medidas em mm:

W26 Chaves: 6; 7; 8; 9; 10; 11; 12; 13; 14; 15; 16; 17; 18; 19; 22 e 24

B



W45112SP 136.00€

Jogo de 12 chaves mistas de boca/ roquete de 72 dentes

Composição/ medidas em mm:

W45 Chaves: 8 a 19

A



W47108SP 71.50€

Jogo de 8 chaves de luneta angular com roquete

Composição/ medidas em mm:

W47 Chaves: 6x7; 8x9; 10x11; 12x13; 14x15; 16x18; 17x19 e 21x22

A



W60115SP 160.00€

Jogo de 15 chaves de boca/ roquete reversível de 72 dentes

Composição/ medidas em mm:

W60 Chaves: 9 a 19
Adaptadores de 1/4"; 3/8" e 1/2"
Porta bits de 10

B



W70A118S 210.00€

Jogo de chaves em "T" com roquete articulado

Composição/ medidas em mm:

W60 Chave em "T" de 300
Chave em "T" de 50
Chave com roquete de 72 dentes
Extensão de 3"
Extensão de 6"
Adaptador 3/8" (F)x3/8" (F)

B



Tabuleiros de ferramenta para carros
Tabuleiros em espuma de alta densidade EVA
JA-C131SV
550.00€
Gaveta para serviço em pneus (gaveta completa)

Composição:

- JAI-0924 Pistola pneumática de 1/2"
- JAR-6309A Roquete pneumático de 1/2"
- JAG-0906R Retificadora pneumática de 1/4"
- Chaves de impacto longas de 1/2"
- Chaves de impacto de 1/2"
- Adaptador de 3/8"-1/2"
- Adaptador de 1/2"-3/8"
- Adaptador de 1/2"-3/4"
- Cardan de 1/2"
- Extensões de 1/2"

D

D71157SV
190.00€
Gaveta com chaves de fenda/ phillips, alicates e bits (gaveta completa)

Composição/ medida em mm:

- Chaves de fenda: 6,5x38; 4x80; 5,5x125 e 6,5x150
- Chaves phillips: PH2x38; PH1x80; PH2x100 e PH3x150
- Chaves de fenda/pancada: 6,5x125; 8x150 e 9,5x175
- Chaves phillips/pancada: PH2x100 e PH3x150
- Bits hexagonais: 4; 5; 6; 7; 8; 10 e 12 de 30 e 75mm de comprimento
- Bits torx: T20; T25; T30; T40; T45; T50 e T55 de 30 e 75mm de comprimento
- Bits XZN: M5; M6; M8; M10 e M12 de 30 e 75mm de comprimento
- Porta bits de 3/8" e 1/2"
- Alicates de freios

D

D737128SV
180.00€
Gaveta com chaves de fenda/ phillips (gaveta completa)

Composição:

- D71PP08SP Jogo de chaves de fenda/ phillips
- D70105SP Jogo de chaves de fenda/ phillips pancada
- M645114SP Jogo de serra, chave inglesa, punções e escopros

D

D737134SV
180.00€
Gaveta com chaves de fendas/ phillips (gaveta completa)

Composição:

- D3750P065S Jogo de chaves de precisão
- D3750T08S Jogo de chaves de precisão
- D70105SP Jogo de chaves de fenda/ phillips pancada
- D71PP08SP Jogo de chaves de fenda/ phillips
- W43A106S Jogo de chaves de caixa flexível

D

H10121SV
139.00€
Gaveta com chaves macho hexagonais de punho, talhadeiras e martelos (gaveta completa)

Composição:

- H10MB08S Jogo de chaves duplas hexagonais de punho
- H10MT08S Jogo de chaves duplas torx tamperproof de punho
- AG010026S Jogo de martelos e talhadeiras

D

P82714SV
220.00€
Gaveta com alicates (gaveta completa)

Composição:

- P018SP Jogo de alicates
- P2710SP Jogo de alicates
- AG010002SP Jogo de alicates de freios
- P71 Jogo de mini alicates

D

P82736SV
237.00€
Gaveta com alicates e bits de caixa (gaveta completa)

Composição:

- S06H427SP Jogo de chaves de caixa bits de 1/2" e 3/8"
- AG010002SP Jogo de alicates de freios
- P018SP Jogo de alicates
- P2710SP Jogo de alicates

D

S04H2184SV

177.00€

Gaveta com 74 peças de 1/4" (gaveta completa)

Composição:

Roquete de 1/4"
 Chaves de caixa de 1/4": 4 a 14mm
 Bits de caixa hexagonais de 1/4": H2 a H6
 Adaptador 3/8"(F) x 1/4" (M)
 Adaptador 1/4" (M) x 3/8" (F) para cabo "T" corrediço
 Cardan de 1/4"
 Extensões de 1/4": 100mm e 150mm
 Manivela 1/4": 150mm
 Cabo "T" corrediço de 1/4": 130mm
 Punho de 1/4" com função fixa/cardan 280mm
 Extensão flexível de 1/4": 145mm
 Bits phillips, fenda, pozidrive, hexagonais, torx
 Chaves de precisão fenda/ phillips
 Chaves de fenda/ impacto 9,5x200mm e 9,5x300mm
 Chave de fenda 5x150mm
 Chave de fenda isolada 1000V 5,5x125mm

D

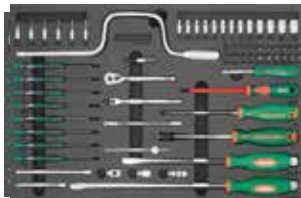

S04H3194SV

215.00€

Gaveta com 94 peças de 1/4" e 3/8" (gaveta completa)

Composição:

Roquete de 1/4"
 Chaves de caixa de 1/4": 5 a 14mm
 Bits de caixa fenda de 1/4": 3,5; 5,5 e 7mm
 Bits de caixa hexagonais de 1/4": H3, H4, H5, H6 e H7
 Bits de caixa phillips de 1/4": PH1; PH2 e PH3
 Bits de caixa torx interior de 1/4": E4; E5; E6; E7 e E8
 Bits de caixa torx de 1/4": T10; T15; T20; T25; T30; T35 e T40
 Punho de 1/4" com função fixa/ cardan 280mm
 Bits torx tamperproof com encaixe de 1/4": T7 a T40
 Bits phillips com encaixe de 1/4": PH1; PH2 e PH3
 Cabo "T" corrediço de 1/4": 115mm
 Extensão de 1/4": 150mm
 Cardan de 1/4"
 Bits e porta bits de 1/4"
 Bit torx tamperproof de 3/8": T55
 Roquete de 1/4" de 36 dentes
 Adaptador 3/8" x 1/4"
 Chaves caixa 3/8": 7 a 22mm
 Chaves torx interior 3/8": E10; E12 e E14
 Chave torx 3/8": T40
 Bits caixa XZN 3/8": M6; M8 e M10
 Extensões 3/8": 75mm e 150mm
 Roquete e roquete flexível de 3/8" com 36 dentes
 Cardan de 3/8"
 Adaptador 1/4" (F) x 3/8" (M)

D



Tabuleiros de ferramenta para carros

Tabuleiros em espuma de alta densidade EVA

S04H42165SV

230.00€

Gaveta com 65 peças de 1/4" e 1/2" (gaveta completa)

Composição:

Roquete de 1/4" de 48 dentes
 Chaves de caixa 1/4": 4 a 13mm
 Chaves de caixa longas de 1/4": 5 a 13mm
 Extensões de 1/4": 50mm e 150mm
 Punho de 1/4"
 Roquete de 1/2" com 48 dentes
 Chaves de caixa 1/2": 10 a 32mm
 Chaves de velas 1/2": 16 e 21mm
 Extensões de 1/2": 125mm e 250mm
 Cabo "T" corrediço
 Cardan de 1/2"
 Chaves mistas de 6 a 24mm

D



S04H4295SV

230.00€

Gaveta com chaves de caixa e roquete (gaveta completa)

Composição:

S04H2125SP Jogo de chaves de caixa com 25 peças de 1/4"
 S04H4131SP Jogo de chaves de caixa com 31 peças de 1/2"
 S29H4140SP Jogo de 40 bits de 1/2" e 3/8"

D

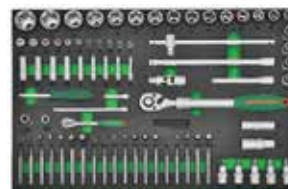

S04H46121SV

308.00€

Gaveta com chaves de caixa e roquete (gaveta completa)

Composição:

S04H3157SP Jogo de chaves de caixa com roquete de 1/4" e 3/8"
 S04H4125SP Jogo de chaves de caixa com roquete de 1/2"
 S29H4140SP Jogo de 40 bits de 1/2" e 3/8"

D



Tabuleiros de ferramenta para carros

Tabuleiros em espuma de alta densidade EVA

W23559SV

205.00€

Gaveta com chaves de fenda/ phillips/ luneta e alicates (gaveta completa)

Composição:

D71PP08SP Jogo de chaves fenda e phillips

W23108SP Jogo de chaves luneta 75°

P0903SP Jogo de alicates

S29H4140SP Jogo de bits de 1/2" e 3/8"

D



W26134SV

210.00€

Gaveta com chaves de luneta/ mistas/ alicates (gaveta completa)

Composição:

W23108SP Jogo de chaves luneta 75°

P0903SP Jogo de alicates

W26112SP Jogo de chaves mistas (boca/ luneta)

H01SM109S Jogo de chaves hexagonais

P28210 Alicata ajustável

P32M10A Alicata de pressão

D



W2623431SV

195.00€

Gaveta com chaves de luneta e mistas (gaveta completa)

Composição:

W23108SP Jogo de chaves luneta 75°

W24106S Jogo de chaves luneta aberta

W26116SP Jogo de chaves mistas boca / luneta

A1050077 Cinta para filtros óleo

D

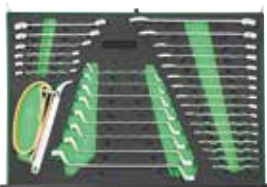

W26315SV

315.00€

Tabuleiro com 15 chaves mistas (gaveta completa)

Composição:

W26 20; 21; 23; 25; 26; 27; 28; 29; 30; 32; 36; 38; 41; 46 e 50mm

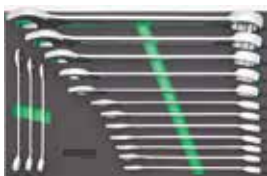

D70105KV

41.00€

Tabuleiro com 5 chaves pancada fenda/ phillips (1/3 de gaveta)

Composição:

D70S6125 Chave fenda 6,5x125mm

D70S8150 Chave fenda 8x150mm

D70S9175 Chave fenda 9,5x175mm

D70P2100 Chave phillips PH2x100mm

D70P3150 Chave phillips PH3x150mm



D71PP08KV

44.00€

Tabuleiro com 8 chaves fenda/ phillips (1/3 de gaveta)

Composição:

D71S Jogo de 4 chaves fenda
6,5x38; 4x80; 5,5x125 e 6,5x150mm

D71P Jogo de 4 chaves phillips
PH1X80; PH2X38; PH2x100 e PH3x150mm

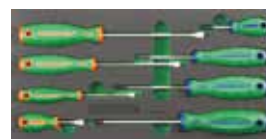

H10MB08KV

44.50€

Tabuleiro com 8 chaves hexagonais de punho (1/3 de gaveta)

Composição:

H10MB Jogo de 8 chaves macho
2x100; 2,5x100; 3x100; 4x100; 5x150; 6x150, 8x200
e 10x200mm

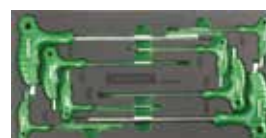

H10MT08KV

44.50€

Tabuleiro com 8 chaves torx tamperproof de punho (1/3 de gaveta)

Composição:

H10MT Jogo de 8 chaves torx
T10x100; T15x100; T20x100; T25x100; T27x150;
T30x150; T45x200 e T50x200mm



M09103KV

58.00€

Tabuleiro com martelos e chave inglesa (1/3 de gaveta)

Composição:

- M09300 Martelo tipo alemão
- M11035 Martelo borracha (anti recuo)
- W27AS10 Chave inglesa



M63113KV

60.00€

Tabuleiro com saca troços, talhadeiras, punções e buril (1/3 de gaveta)

Composição:

- 6 Saca troços
- 4 Talhadeiras
- 1 Buril
- 1 Punção de bico
- 1 Punção



MHS08KV

65.00€

Tabuleiro com serra e vários (2/3 de gaveta)

Composição:

- 1 Serra com 2 lâminas extra
- 1 Fita métrica 3m
- 1 Régua 330mm
- 1 X-ato



P011804KV

71.00€

Tabuleiro com 4 alicates (1/3 de gaveta)

Composição:

- P0817 1 Alicate universal
- P1017 1 Alicate de corte diagonal
- P1118 1 Alicate de pontas
- P2710 1 Alicate ajustável



Tabuleiros de ferramenta para carros

Tabuleiros em espuma de alta densidade EVA

P32M105KV

68.00€

Tabuleiro com 5 alicates (1/3 de gaveta)

Composição:

- AG010002 1 Alicate de freios interiores direito
- AG010005 1 Alicate de freios interiores curvo
- AG010008 1 Alicate de freios exteriores direito
- AG010011 1 Alicate de freios exteriores curvo
- P32M10A 1 Alicate de pressão

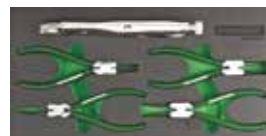

S03A4122KV

97.00€

Tabuleiro com 22 chaves de impacto 1/2" (1/3 de gaveta)

Composição:

- S03A Jogo chaves impacto
10; 11; 12; 13; 14; 16; 17; 19; 21; 22 e 24
- S03AD Jogo chaves impacto longa
10; 11; 12; 13; 14; 16; 17; 19; 21; 22 e 24



S04H2132KV

124.00€

Tabuleiro com 32 peças, chaves de bits e extensões (1/3 de gaveta)

Composição:

- S09H3 Chaves caixa bit hexagonais 1/2"
- S09H4 Chaves caixa bit hexagonais 3/8"
- S49H4 Chaves caixa bit estriado 1/2"
- S24H4 Extensões 1/2" - 125 e 250mm
- S17H4 Chaves velas - 16 e 21mm
- S23H4125 Cabo em "t" corrediço



S04H4144KV

130.00€

Tabuleiro com 44 peças, chaves caixa com roquete (1/3 de gaveta)

Composição:

- R3704 Roquete 1/2"
- R3702 Roquete 1/4"
- S04H4 Chaves caixa 1/2"
10; 11; 12; 13; 14; 15; 16; 17; 18; 19; 20; 21; 22; 23; 24;
27; 30 e 32mm
- S04H2 Chaves caixa 1/4"
4; 5; 5,5; 6; 7; 8; 9; 10; 11; 12 e 13mm
- S04HD2 Chaves caixa longa 1/4"
5; 6; 7; 8; 9; 10; 11; 12 e 13mm
- S24H2 Extensões 1/4" - 50 e 150mm
- S26H2150 Punho 1/4"
- S15H472 Cardan 1/4"



Tabuleiros de ferramenta para carros
Tabuleiros em espuma de alta densidade EVA
S06H427KV 95.00€

Tabuleiro com 27 bits de caixa (1/3 de gaveta)

Composição:

- S09H3** 6x Bits hexagonais de 3/8"
S09H4 11x Bits hexagonais de 1/2"
S49H4 10x Bits estriados de 3/8"

S29H4141KV 68.50€

Tabuleiro com 41 peças, jogo de bits (1/3 de gaveta)

Composição:

- Bits hexagonais
- Bits torx
- Bits estriados
- Porta bits 1/2"
- Porta bits 3/8"
- Chave para molas de travão

W25106KV 34.00€

Tabuleiro com 6 chaves de bocas (1/3 de gaveta)

Composição:

- W25** 6x7; 8x9; 10x11; 12x13; 14x15 e 16x17

W25107KV 81.00€

Tabuleiro com 7 chaves de bocas (2/3 de gaveta)

Composição:

- W25** 18-19; 20-22; 21-23; 24-16; 25-28; 27-30 e 30-32mm

W25110KV 60.00€

Tabuleiro com 10 chaves de bocas (1/3 de gaveta)

Composição:

- W25** 6x7; 8x9; 10x11; 12x13; 14x15; 16x17; 18x19; 21x23; 24x27 e 30x32

W26108KV 85.00€

Tabuleiro com 8 chaves mistas (2/3 de gaveta)

Composição:

- W26** 18; 19; 21; 22; 24; 27; 30 e 32mm

W26110KV 45.00€

Tabuleiro com 10 chaves mistas (1/3 de gaveta)

Composição:

- W26** 6; 7; 8; 10; 11; 12; 13; 14; 16 e 17mm

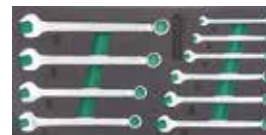
W26116KV 69.00€

Tabuleiro com 16 chaves mistas - boca/ luneta (1/3 de gaveta)

Composição:

- W26** 6; 7; 8; 9; 10; 11; 12; 13; 14; 15; 16; 17; 18; 19; 20 e 22mm

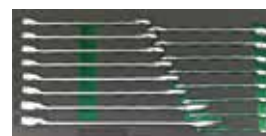
W65105KV 69.00€

Tabuleiro com 5 chaves curva luneta (1/3 de gaveta)

Composição:

- 8x10; 10x12; 13x15; 14x17 e 19x22mm

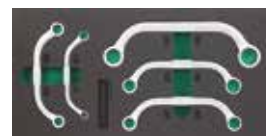

AG10002SC

55.00€

Jogo de machos e caçonetes

Composição:

- Machos M3 a M12
- Caçonetes M3 a M12
- Porta caçonetes
- Desandador de machos



D376514SC

40.50€

Jogo de chaves

Composição:

- Jogo de chaves de precisão
- Phillips: PH00; PH0 e PH1
- Fenda: 2; 2,4 e 3mm
- Torx: T5; T6; T7; T8; T9; T10; T15 e T20



P0813SC

44.00€

Jogo de alicates

Composição:

- P087** Alicate universal
- P097** Alicate de corte
- P118** Alicate de pontas



R4811SC

63.00€

Jogo de chaves de caixa de 1/4" e 3/8"

Composição/ medidas em mm:

- Roquete de 1/4" de 72 dentes
- Roquete de 3/8" de 72 dentes
- Extensão de 3/8": 75
- Extensão de 3/8": 250
- Extensão de 1/4": 50
- Extensão de 1/4": 150
- Cardan de 1/4"
- Cardan de 3/8"
- Adaptador 1/4" - 3/8"
- Adaptador 3/8" - 1/2"
- Punho



S04H5129SC

50.00€

Jogo de chaves de caixa sextavadas de 1/4 e 3/8" com 28 peças

Composição/ medidas em mm:

- Chaves de caixa de 1/4": 4; 4,4; 5; 5,5; 6; 7; 8; 9; 10; 11; 12 e 13
- Chaves de caixa longa: 8; 10; 12 e 13
- Chaves de caixa 3/8": 14; 15; 17; 18; 19; 20; 22 e 24
- Chaves de caixa longa: 14; 15 e 17
- Chaves de velas 3/8": 16 e 21



V11011SC

41.50€

Jogo com alicate de cravar fêmeas

Composição/ medidas em mm:

- Alicate de cravar
- Bicos M3 a M6



W25117SC

58.00€

Jogo de chaves bocas e hexagonais

Composição/ medidas em mm:

- Chaves de bocas: 8x9; 10x11; 12x13; 14x15; 16x17; 18x19; 20x22 e 24x27
- Chaves hexagonais: 1,2; 2; 2,5; 3; 4; 5; 6; 8 e 10



W27AT02SC

50.00€

Jogo de alicates

Composição/ medidas em mm:

- P32M10C** Alicate de pressão
- W27AT10** Chave ajustável



Tabuleiros de ferramenta vazios

Tabuleiros em espuma EVA aplicáveis aos carros: C4DWA1, C-6DWB1 e C-7DW1

P-EVA(D71PP08KV)

10.00€



P-EVA(D737128SV)

29.60€



P-EVA(D737134SV)

29.60€



P-EVA(H10MB08KV)

10.00€



P-EVA(H10MT08KV)

10.00€



P-EVA(H10121SV)

29.60€



P-EVA(P82736SV)

29.60€



P-EVA(M09103KV)

10.00€



P-EVA(M63113KV)

10.00€

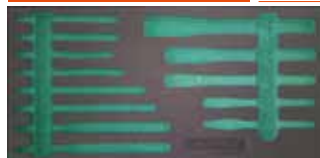

P-EVA(MHS08KV)

19.00€



P-EVA(P011804KV)

10.00€



P-EVA(P32M105KV)

10.00€



P-EVA(P82714SV)

29.60€



Tabuleiros em espuma EVA aplicáveis aos carros: C4DWA1, C-6DWB1 e C-7DW1

P-EVA(S03A4122KV)

10.00€



P-EVA(S04H2132KV)

10.00€



P-EVA(S04H4144KV)

10.00€



P-EVA(S04H4295SV)

29.60€

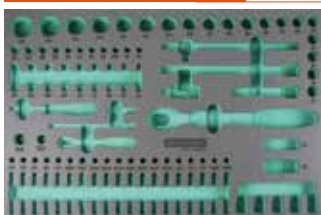

P-EVA(S04H42165SV)

29.60€



P-EVA(S04H45121SV)

29.60€

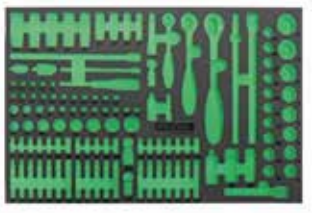

P-EVA(S29H4141KV)

10.00€



P-EVA(W23559SV)

29.60€



P-EVA(W25110KV)

10.00€



P-EVA(W26116KV)

10.00€



P-EVA(W26134SV)

29.60€



P-EVA(W2623431SV)

29.60€

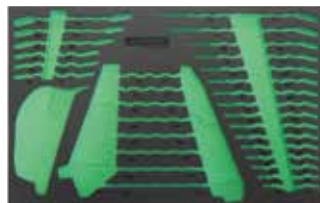

Tabuleiros de ferramenta

Caixas plásticas para tabuleiros

P-B (31)

5.50€

Medidas:

425x185x52mm

B



P-B (41)

4.50€

Medidas:

375x144,5x52mm

A



Tabuleiros de ferramenta vazios para composições

aplicáveis aos carros: C-4DW, C-6DW e C-7DW

P-TR(AG010002SP)	2.20€
P-TR(AG010026SP)	2.20€
P-TR(AI10002SP)	2.50€
P-TR(D70105SP)	2.20€
P-TR(D71PP08SP)	2.20€
P-TR(H10MB08SP)	2.50€
P-TR(M09513SP)	2.20€
P-TR(M645114SP)	2.50€
P-TR(P04704SP)	2.20€
P-TR(P0803SP)	2.20€
P-TR(P0903SP)	2.20€
P-TR(S03A4122SP)	2.20€
P-TR(S04H2125SP)	2.20€
P-TR(S04H3157SP)	2.70€
P-TR(S04H3536SP)	2.70€
P-TR(S04H4125SP)	2.70€
P-TR(S04H4524SP)	2.20€
P-TR(S04H4726SP)	2.80€
P-TR(S04H4728SP)	2.80€
P-TR(S06H427SP)	2.20€
P-TR(S09H4118SP)	2.20€
P-TR(S29H4140SP)	2.70€
P-TR(W23108SP)	2.20€
P-TR(W25110SP)	2.20€
P-TR(W26112SP)	2.20€
P-TR(W26116SP)	2.50€



Tabuleiros de ferramenta vazios para composições

aplicáveis à mala: C-3DH2

P-TR (D70SP06ST)

1.50€

Para chaves D70



P-TR (PC303ST)

1.50€

Para alicates: P087; P106 e P118



P-TR (S04H4120ST)

1.70€

Para chaves de caixa de 1/2" com roquete



P-TR (S04H4506ST)

1.70€

Para extensões



P-TR (W26107ST)

1.70€

Para chaves mistas W26



P-TR (W26920ST)

1.50€

Para chaves mistas W26 e chaves hexagonais



T21

Chave dinamométrica com precisão de: +/- 3%

Ref.	Quadra	Torque (Nm)	Comp. (mm)	Preço
T21025N	1/4"	5-25	320	99.90€
T21050N	3/8"	10-50	390	104.00€
T211000N	1"	200-1 000	1 510	535.00€
T21101N	1/2"	20-100	390	112.00€
T21200N	1/2"	40-200	502	112.00€
T21340N	1/2"	60-340	604	137.00€
T21341N	3/4"	60-340	604	147.00€
T21550N	3/4"	110-550	938	340.00€

T25

Chave dinamométrica com precisão de: +/- 4%

Ref.	Quadra	Torque (Nm)	Comp. (mm)	Preço
T25100N	3/8"	20-100	390	85.50€
T25200N	1/2"	40-200	502	92.00€
T25340N	1/2"	60-340	604	112.00€

T27

Chave dinamométrica com precisão de: +/- 4%

Ref.	Quadra	Torque (Nm)	Comp. (mm)	Preço
T27010N	1/4"	2-10	308	60.50€
T27020N	1/4"	4-20	340	59.50€
T27021N	3/8"	4-20	340	60.00€
T27060N	3/8"	10-60	340	66.50€
T271001N	1"	200-1 000	1 177	445.00€
T27101N	1/2"	20-100	458	75.00€
T27200N	1/2"	40-200	531	78.50€
T27340N	1/2"	60-340	585	86.50€
T27800N	3/4"	150-800	1 177	373.00€

T30200NS

233.00€

 Barra dinamométrica com conjunto de 9 ponteiros de bocas -
 Precisão 4%

Composição:

- Torque: 40-200 Nm
- Cabeçote 1/2"
- Encaixe: 14x18mm
- Ponteiras: 13; 14; 15; 17; 19; 22; 24; 27 e 30mm

Ferramenta de aperto
T33

Chave dinamométrica reversível

 Precisão: sentido horário: 4%
 sentido anti-horário: 6%

Ref.	Quadra	Torque (Nm)	Preço
T33050N	3/8"	10-50	103.00€
T33101N	1/2"	20-100	107.00€
T33200N	1/2"	40-200	108.00€
T33341N	3/4"	60-340	140.00€

T10H1210S

302.00€

Jogo de chave dinamométrica com 7 chaves intermutáveis 14x18

Torque: 40-210 Nm

T103

Chave "Pata de Galo" 14x18

Ref.	Medida (mm)	Preço
T10313	13	10.20€
T10314	14	10.20€
T10315	15	10.20€
T10316	16	10.20€
T10317	17	10.20€
T10318	18	10.20€
T10319	19	10.20€
T10321	21	10.20€
T10322	22	10.20€
T10324	24	10.50€

T29014

21.50€

Cabeçote para chave dinamométrica de cabeças intermutáveis

 Quadra: 1/2"
 14/18mm

T14100N

240.00€

Chave dinamométrica digital intermutável com precisão de: +/- 1%

 Capacidade: 10-100Nm
 Comprimento: 420mm
 Peso: 840g
 Cabeçote: 14x18

 Memória: 10 leituras
 Unidade: Nm; lb-ft; Kg-m; in-lb
 Pilhas: 3x1,5v AA (não incluídas)

Ferramenta de aperto

T14200N

250.00€

Chave dinamométrica digital intermutável com precisão de: +/- 1%

Capacidade: 20-200Nm
Comprimento: 550mm
Peso: 1 150g
Cabeçote: 14x18

Memória: 10 leituras
Unidade: Nm; fb-lb; Kg-m; in-lb
Pilhas: 3x1,5v AA (não incluídas)



T154100N

230.00€

Chave dinamométrica digital com precisão de: +/- 1%

Capacidade: 10-100Nm
Comprimento: 440mm
Peso: 1 060g
Cabeçote: 14x18

Memória: 10 leituras
Unidade: Nm; fb-lb; Kg-m; in-lb
Pilhas: 3x1,5v AA (não incluídas)
Quadra: 1/2"



T24200

330.00€

Chave dinamométrica digital com aperto à esquerda e à direita
Precisão de: +/- 2% à direita | +/- 3% à esquerda

Capacidade: 10-200Nm
Comprimento: 530mm
Quadra: 1/2"

Memória: 50 leituras
Unidade: Nm; fb-lb; Kg-cm; in-lb

Alimentação: 2 baterias tipo AA (não incluídas)



T19

Medidor digital de torque com precisão de: +/- 2%

Com aviso luminoso e sonoro

Ref.	Quadra	Torque (Nm)	Preço
T19135N	3/8"	10-135	63.00€
T19200N	1/2"	20-200	63.00€



T

Kits de reparação para chaves dinamométricas

Ref.	Aplicáveis aos modelos	Preço
T04M060-R	T04M060	6.80€
T04M061-R	T04M061	6.80€
T04M150-R	T04M150	9.00€
T04M250-R	T04M250	12.00€
T07030N-R	T07030N	6.60€
T07110N-R	T07110N	7.20€
T07350N-R	T07350N	12.00€
T07700N-R	T07700N	48.50€
T102001S-R	T102001S	11.60€
T154100N-R	T154100N	9.00€
T154200N-R	T154200N	13.80€
T16005N-R	T16005N	8.00€
T21025N-R	T21025N	8.70€
T21050N-R	T21050N	10.00€
T211000N-R	T211000N	56.50€
T21101N-R	T21101N	12.00€
T21200N-R	T21200N	12.00€
T21340N-R	T21340N	11.50€
T21341N-R	T21341N	40.00€
T21550N-R	T21550N	40.00€
T24200-R	T24200	21.00€
T25100N-R	T25100N	10.00€
T25200N-R	T25200N	11.20€
T25340N-R	T25340N	11.20€
T27-D2R	T27010N, T27020N, T27030N	6.50€
T27-D3R	T27021N, T27031N, T27060N, T27100N	7.20€
T27-D4R1	T27101N	8.30€
T27-D4R2	T27200N, T27340N	9.70€
T27-D6R	T27500N, T27600N, T27800N, T271000N	23.80€
T27-D8R	T27801N, T271001N	39.50€
T33050N-R	T33050N	11.50€
T33101N-R	T33101N	12.50€
T33200N-R	T33200N	12.50€
T33341N-R	T33341N	14.00€

R12

Roquete reversível de 60 dentes

Ref.	Quadra	Comp. (mm)	Preço
R1206N	3/4"	500	57.50€
R12081	1"	675	126.00€



R29

Roquete reversível de 36 dentes

Ref.	Quadra	Comp. (mm)	Preço
R2902	1/4"	146	11.60€
R2904	1/2"	278	17.50€



R34

Roquete de 72 dentes com punho antideslizante

Ref.	Quadra	Comp. (mm)	Torque (Nm)	Preço
R3403	3/8"	196	245	19.30€

R35

Roquete de 72 dentes com punho antideslizante

Ref.	Quadra	Comp. (mm)	Torque (Nm)	Preço
R3502	1/4"	135	68	13.50€
R3503	3/8"	199	245	16.00€
R3504	1/2"	250	647	20.00€

R36

Roquete metálico reversível de 48 dentes

Ref.	Quadra	Comp. (mm)	Torque (Nm)	Preço
R3602	1/4"	128	68	13.00€
R3603	3/8"	198	245	16.00€

R37

Roquete reversível de 48 dentes com punho antideslizante

Ref.	Quadra	Comp. (mm)	Torque (Nm)	Preço
R3702	1/4"	135	68	13.20€
R3703	3/8"	198	245	16.70€
R3704	1/2"	353	647	19.50€

R37B

Roquete reversível curto de 48 dentes com punho antideslizante

Ref.	Quadra	Comp. (mm)	Torque (Nm)	Preço
R3702B	1/4"	110	68	12.90€
R3704B	1/2"	180	647	18.00€

R41

Roquete reversível e articulado de 36 dentes com punho antideslizante

Ref.	Quadra	Comp. (mm)	Preço
R4103	3/8"	238	17.50€
R4104	1/2"	288	22.40€

R45

Roquete reversível e rotativo de 48 dentes

Ref.	Quadra	Comp. (mm)	Preço
R4502	1/4"	185	29.30€

R48

Roquete metálico reversível de 72 dentes

Ref.	Quadra	Comp. (mm)	Preço
R4802A	1/4"	125	11.00€
R4804A	1/2"	250	17.70€

R48

Roquete curto reversível de 72 dentes

Ref.	Quadra	Comp. (mm)	Peso (g)	Preço
R4804B	1/2"	170	442	17.10€

R51

Roquete reversível e extensível de 72 dentes com punho antideslizante

Ref.	Quadra	Comp. (mm)	Preço
R5104	1/2"		23.50€

R66

Roquete com cabo rotativo de 60 dentes

Ref.	Quadra	Comp. (mm)	Peso (g)	Preço
R6602	1/4"	180	181	35.00€
R6603	3/8"	290	645	38.00€
R6604	1/2"	240	384	43.50€



R68

Roquete reversível de baixo perfil de 60 dentes

Ref.	Quadra	Peso (g)	Preço
R6802	1/4"	165	14.00€
R6803	3/8"	265	18.00€
R6804	1/2"	520	20.00€



RD01

13.50€

Mini roquete

Quadra: 1/4"
Dentes: 60
Comprimento: 200mm



RD02

16.00€

Mini roquete flexível

Quadra: 1/4"
Dentes: 60
Comprimento: 170mm



T094602

295.00€

Roquete desmultiplicador 1/2" - 3/4" R 1:9

Torque máximo: 1 500 Nm



T094602-RK

220.00€

Kit de reparação

T096801

320.00€

Roquete desmultiplicador 3/4" - 1" R 1:4

Torque máximo: 2 500 Nm



T096801-RK

215.00€

Kit de reparação

T10148

85.00€

Aparafusador de torque com jogo de bits

Quadra	Torque (Nm)
1/4"	1-8



R

Kits de reparação para roquetes

Ref.	Aplicáveis aos modelos	Preço
R1206R	R1206R	18.00€
R2902RK	R2902; R2902A; R2902B	5.30€
R2903RK	R2903; R2903A; R2903B; R4103	5.90€
R2904RK	R2904; R2904A; R2904B; R4104	6.70€
R3602RK	R3602; R3702; R3702B; R3802	6.80€
R3603RK	R3603; R3703; R3803	8.80€
R3604RK	R3604; R3704; R3704B; R3804	9.50€
R3402RK	R3402; R3502	7.00€
R3403RK	R3403; R3503	8.90€
R3404RK	R3404; R3504	9.90€
R4502RK	Para cabeça de roquete	6.50€
R4502JRK	Para articulação	6.50€
R4802RK	R4802	5.20€
R4804RK	R4804	6.20€
R5104RK	R5104	7.70€
R5802ERK	R5802E	9.40€
R5803RK	R5803	11.50€
R5804ERK	R5804E	14.80€
R5804LRK	R5804L	14.80€
R6802RK	R68	8.80€
R6803RK	R68	10.70€
R6804RK	R68	12.00€
R12081RK	R12081	58.00€



W24A107S

86.50€

Jogo de chaves luneta aberta flexível

Composição:

Chaves: 8x8; 10x10; 11x11; 12x12; 13x13; 14x14 e 17x17



W45

Chave combinada boca/ roquete



Ref.	Medida (mm)	Comp. (mm)	Preço
W45108	8	135,40	7.70€
W45109	9	159,50	8.00€
W45110	10	159,50	8.10€
W45111	11	165,90	8.30€
W45112	12	168,60	8.50€
W45113	13	178,50	9.00€
W45114	14	190,50	9.50€
W45115	15	199,40	10.50€
W45116	16	206,40	10.90€
W45117	17	225,40	11.60€
W45118	18	236,40	13.00€
W45119	19	247,40	13.00€
W45121	21	281,00	19.90€
W45122	22	281,00	21.90€
W45124	24	281,00	22.50€
W45127	27	330,00	34.00€
W45130	30	425,00	47.00€
W45132	32	425,00	48.90€

W45110S

84.00€

Jogo de chaves de boca/ roquete de 9 peças

Composição:

W45 Chaves: 8; 10; 12; 13; 17 e 19mm
 Adaptadores 1/4"; 3/8" e 1/2"
 Porta bits

W45117S

320.00€

Jogo de chaves combinadas boca/ roquete com 72 dentes de 17 peças

Composição:

W45 Chaves: 8; 10; 12; 13; 14; 17; 19; 21; 22; 24; 27; 30 e 32mm
 Adaptadores 1/4"; 3/8"; 1/2" e 3/4"
 Porta bits
 Mala

W45316S

142.00€

Jogo de chaves combinadas boca/ roquete com 72 dentes de 16 peças

Composição:

W45 Chaves: 8 a 19mm
 Adaptadores 1/4"; 3/8" e 1/2"
 Porta bits
 Mala

W45316S-AD

13.80€

Conjunto de 4 adaptadores

Composição:

 Adaptadores 1/4"; 3/8" e 1/2"
 Porta bits

W45316S-AD12

5.10€

Adaptador 1/2" para chave 19mm

W45316S-AD14

3.60€

Adaptador 1/4" para chave 10mm

W45316S-AD34

13.80€

Adaptador 3/4" para chave 32mm

W45316S-AD38

4.30€

Adaptador 3/8" para chave 13mm

W45316S-ADBH14

1.75€

Porta bits 1/4" para chave 10mm

W51110S

107.00€

Jogo de 10 chaves curtas boca/ roquete

Composição:

W51 Chaves: 8; 10; 11; 12; 13; 14; 15; 16; 17 e 19mm

W52105S

75.00€

Jogo de 5 chaves curtas boca/ roquete flexível

Composição:

W52 Chaves: 8; 10; 12; 14 e 17mm



W66

Chave de boca/ roquete flexível

Ref.	Medida (mm)	Comp. (mm)	Preço
W66108	8	137	13.15€
W66109	9	159	13.25€
W66110	10	159	13.25€
W66111	11	175	14.20€
W66112	12	175	15.00€
W66113	13	186	15.00€
W66114	14	194	15.90€
W66115	15	216	16.60€
W66116	16	216	18.00€
W66117	17	232	18.00€
W66118	18	250	19.00€
W66119	19	250	19.60€
W66124	24		34.00€



W66107S

107.00€

Jogo de 7 chaves de boca/ roquete flexível

Composição:

W66 Chaves: 8; 10; 11; 13; 14; 17 e 19mm



W66116S

207.00€

Jogo de chaves combinadas boca/ roquete flexível de 72 dentes com 16 peças

Composição:

W66 Chaves: 8 a 19mm
Adaptadores 1/4"; 3/8" e 1/2"
Suporte de bit
Mala



W67104S

56.00€

Jogo de chaves luneta (torx) com roquete

Composição:

Chaves: E6xE8; E10xE12;
E14xE18 e E20xE24mm



W68

Chave roquete de 72 dentes

Ref.	Medida (mm)	Preço
W680809	8x9	12.45€
W680810	8x10	12.60€
W681011	10x11	13.00€
W681213	12x13	13.50€
W681415	14x15	15.90€
W681618	16x18	16.90€
W681719	17x19	18.90€



W68106S

85.00€

Jogo de chaves roquete de 72 dentes com 6 peças

Composição:

W68 Chaves: 8x9; 10x11; 12x13;
14x15; 16x18 e 17x19



W73

Chave 4 em 1 com roquete

Ref.	Medida (mm)	Preço
W7310813	8x10 12x13	19.40€
W7311419	14x17 18x19	24.50€



W73102S

42.00€

Jogo de chaves com roquete 4 em 1

Podendo ser utilizadas em 4 medidas

Composição/ medidas em mm:

Chave 8x10 - 12x13
Chave 14x17 - 18x19



W91107S

80.10€

Jogo de chaves combinadas boca especial/ roquete de 72 dentes

Composição:

Chaves: 10; 12; 13; 14; 15; 17 e 19mm

W91

Chave boca especial/ luneta com roquete



Ref.	Medida (mm)	Comp. (mm)	Preço
W91110	10	159,5	9.70€
W91112	12	168,6	10.00€
W91113	13	178,5	10.40€
W91114	14	190,5	11.10€
W91115	15	199,4	11.90€
W91117	17	225,4	13.30€
W91119	19	247,4	14.80€

W93108S

111.00€

Jogo de chaves mistas com roquete reversível e anel de retenção

Composição:

Chaves: 10; 11; 12; 13; 14; 15; 17 e 19mm

W93

Chave mista boca roquete com anel retenção



Ref.	Medida (mm)	Comp. (mm)	Preço
W93110	10	158	11.70€
W93111	11	164	12.20€
W93112	12	167	13.30€
W93113	13	177	13.80€
W93114	14	189,4	14.30€
W93115	15	198	15.30€
W93117	17	224	17.60€
W93119	19	245	19.90€

Ferramenta de aperto
W61

Chave luneta longa



Ref.	Medida (mm)	Comp. (mm)	Preço
W611011	10x11	295	9.70€
W611214	12x14	330	11.20€
W611315	13x15	370	13.20€
W611618	16x18	405	14.80€
W611719	17x19	405	15.30€
W612224	22x24	435	21.90€

W61106S

92.00€

Jogo de 6 chaves luneta longas

Fornecido em bolsa plástica com divisórias

Composição:

Medida	Comp. (mm)
10x11	235
12x14	330
13x15	370
16x18	405
17x19	405
22x24	435

W62

Chave luneta direita



Ref.	Medida (mm)	Comp. (mm)	Preço
W6210607	6x7	120	3.55€
W6210809	8x9	135	3.90€
W6211011	10x11	150	4.10€
W6211213	12x13	165	4.60€
W6211415	14x15	210	5.10€
W6211617	16x17	210	5.90€
W6211819	18x19	225	6.10€
W6212022	20x22	240	7.15€
W6212427	24x27	270	11.70€
W6212528	25x28	285	12.70€
W6213032	30x32	335	14.80€

W62108S

45.00€

Jogo de 8 chaves luneta direita

Composição:

W62 Chaves: 6x7; 8x9; 10x11; 12x13; 14x15; 16x17; 18x19 e 20x22mm



W23

Chave luneta 75°



Ref.	Medida (mm)	Preço
W230607	6x7	3.45€
W230809	8x9	3.55€
W231011	10x11	4.30€
W231213	12x13	4.70€
W231415	14x15	5.40€
W231617	16x17	5.90€
W231819	18x19	6.90€
W232022	20x22	8.40€
W232123	21x23	9.50€
W232426	24x26	11.00€
W232427	24x27	11.00€
W232528	25x28	11.40€
W233032	30x32	13.30€



W23108S

51.00€

Jogo de 8 chaves luneta 75°

Fornecido em bolsa plástica com divisórias

Composição:

W23 Chaves: 6x7; 8x9; 10x11; 12x13; 14x15; 16x17; 18x19 e 20x22mm



W24

Chave luneta aberta



Ref.	Medida (mm)	Faces	Preço
W240809	8x9	6	2.85€
W241011	10x11	6	3.10€
W241012	10x12	6	3.10€
W241314	13x14	6	3.60€
W241417	14x17	6	4.80€
W241617	16x17	12	5.10€
W241719	17x19	12	5.70€
W241819	18x19	12	6.10€
W241922	19x22	12	7.40€
W242528	25x28	12	11.60€
W243032	30x32	12	12.70€

W24106S

31.00€

Jogo de 6 chaves luneta aberta

Fornecido em bolsa plástica com divisórias

Composição:

W24 Chaves: 8x9; 10x11; 10x12; 13x14; 16x17 e 17x19mm



W24N

Chave luneta aberta com batente



Ref.	Medida (mm)	Comp. (mm)	Preço
W24N0810	8x10	122	6.60€
W24N1113	11x13	143	7.65€
W24N1214	12x14	145	7.90€
W24N1719	17x19	162	11.00€

W25

Chave de bocas



Ref.	Medida (mm)	Preço
W250607	6x7	2.00€
W250809	8x9	2.15€
W251011	10x11	2.40€
W251012	10x12	2.50€
W251213	12x13	2.75€
W251415	14x15	3.15€
W251417	14x17	3.55€
W251617	16x17	3.65€
W251719	17x19	4.30€
W251819	18x19	4.30€
W252022	20x22	5.40€
W252123	21x23	5.70€
W252426	24x26	7.00€
W252427	24x27	7.00€
W252528	25x28	8.60€
W252730	27x30	9.70€
W252732	27x32	10.00€
W253032	30x32	10.20€
W253236	32x36	17.75€
W253641	36x41	24.50€
W254146	41x46	36.75€
W254650	46x50	50.00€

W25108S

34.00€

Jogo de 8 chaves de bocas

Fornecido em bolsa plástica com divisórias

Composição:

W25 Chaves: 6x7; 8x9; 10x11; 12x13; 14x15; 16x17; 18x19 e 20x22mm



W26

Chave de bocas/ luneta

Ref.	Medida (mm)	Preço
W26106	6	1.85€
W26107	7	1.95€
W26108	8	2.00€
W26109	9	2.10€
W26110	10	2.20€
W26111	11	2.30€
W26112	12	2.45€
W26113	13	2.70€
W26114	14	2.90€
W26115	15	3.20€
W26116	16	3.25€
W26117	17	3.90€
W26118	18	4.30€
W26119	19	4.60€
W26120	20	5.20€
W26121	21	5.60€
W26122	22	5.70€
W26123	23	6.20€
W26124	24	6.60€
W26125	25	7.20€
W26126	26	7.70€
W26127	27	8.20€
W26128	28	8.70€
W26129	29	9.40€
W26130	30	10.00€
W26132	32	11.00€
W26134	34	19.40€
W26136	36	23.90€
W26138	38	29.80€
W26141	41	35.00€
W26142	42	35.00€
W26144	44	44.90€
W26146	46	45.90€
W26148	48	61.70€
W26150	50	62.20€
W26155	55	104.00€
W26160	60	135.00€
W26165	65	178.00€

W26
Jogo de chaves de boca/ luneta

Fornecido em bolsa plástica com divisórias

Ref.	Chaves	Medida (mm)	Preço
W26112S	12xW26	8 a 17; 19 e 22	47.00€
W26114S	14xW26	10 a 14; 16; 17; 19; 21; 22; 24; 27; 30 e 32	81.50€
W26126S	26xW26	6 a 32	146.00€

W26411PRS

55.00€

Jogo de 11 chaves mistas longas

Fornecido em bolsa plástica com divisórias

Composição:

W264 Chaves: 7; 8; 9; 10; 11; 12; 13; 14; 15; 17 e 19mm

W26414S

127.00€

Jogo de 14 chaves mistas boca/ luneta SAE

Fornecido em bolsa plástica com divisórias

Composição:

W26 Chaves: 3/8"; 7/16"; 1/2"; 9/16"; 5/8"; 11/16"; 13/16"; 7/8"; 15/16"; 1"; 1-1/16"; 1-1/8"; 1-1/4"

W29
Chave luneta para parafusos torx

Ref.	Medida	Comp. (mm)	Preço
W290608	E6xE8	112	5.30€
W290711	E7xE11	125	6.20€
W291012	E10xE12	140	6.20€
W291418	E14xE18	180	6.20€
W291622	E16xE22	200	6.90€
W292024	E20xE24	224	6.90€

W39
Chave de bocas de perfil fino

Ref.	Medida (mm)	Comp. (mm)	Preço
W391011	10x11	175	4.60€
W391213	12x13	210	5.60€
W391415	14x15	210	5.60€
W391617	16x17	250	8.20€
W391819	18x19	250	8.20€

W39108SA

69.00€

Jogo de 8 chaves de bocas de perfil fino

Composição:

W39 Chaves: 6x7; 8x9; 10x11; 12x13; 14x15; 16x17; 18x19 e 20x22mm

W69116S

119.50€

Jogo de 16 chaves mistas 75°

Composição:

W69 Chaves: 7; 8; 9; 10; 11; 12; 13; 14; 15; 16; 17; 18; 19; 21; 22 e 24mm



S57

Chaves de cachimbo



Ref.	Medida (mm)	Preço
S57H108	8	6.90€
S57H110	10	8.70€
S57H111	11	8.80€
S57H113	13	13.50€
S57H115	15	13.60€
S57H116	16	14.20€
S57H117	17	15.50€
S57H118	18	16.00€
S57H119	19	16.40€
S57H121	21	23.00€
S57H123	23	29.50€
S57H125	25	33.60€
S57H127	27	42.00€
S57H132	32	57.50€

S57H108S

99.00€

Jogo de 8 chaves de cachimbo

Fornecido em bolsa plástica com divisórias

Composição:

S57 Chaves: 8; 10; 11; 13; 16; 17; 18 e 19mm



W65

Chave curva luneta para motores de arranque



Ref.	Medida (mm)	Preço
W6510810	8x10	3.15€
W6511012	10x12	3.70€
W6511315	13x15	4.10€
W6511417	14x17	5.10€
W6511922	19x22	6.20€

W65A

Chave curva luneta



Ref.	Medida	Comp. (mm)	Preço
W65A1012	10x12	141	6.80€
W65A1214	12x14	166	8.45€
W65A1315	13x15	190	10.90€
W65A1618	16x18	220	12.75€
W65A1719	17x19	220	13.00€
W65A1922	19x22	256	15.30€
W65A2224	22x24		19.00€

W65A105S

54.00€

Jogo de 5 chaves curvas luneta

Composição:

W65A Chaves: 10x12; 12x14; 13x15; 16x18 e 17x19mm



W43A

Chave de caixa flexível



Ref.	Medida (mm)	Comp. (mm)	Preço
W43A0607	6x7	180	5.10€
W43A0809	8x9	180	5.10€
W43A1011	10x11	202	5.50€
W43A1213	12x13	222	6.50€
W43A1415	14x15	245	7.55€
W43A1617	16x17	260	8.55€
W43A1819	18x19	280	10.00€

W43A106S

47.50€

Jogo de 6 chaves de caixa flexíveis

Composição:

W43A Chaves: 8x9; 10x11; 12x13; 14x15; 16x17 e 18x19mm
Mala



W77A

Chave luneta 70° para extensão
Utiliza extensão da série W77H



Ref.	Medida (mm)	Comp. (mm)	Preço
W77A124	24	180	17.90€
W77A127	27	190	20.70€
W77A130	30	200	24.00€
W77A132	32	235	28.00€
W77A136	36	245	33.60€
W77A138	38	245	34.70€
W77A141	41	265	40.30€
W77A146	46	280	47.00€
W77A150	50	290	50.00€
W77A155	55	300	73.50€
W77A160	60	345	97.00€
W77A165	65	355	117.40€

W77H

Extensão para chave W77A
Utilizável em conjunto com as chaves da série W77A



Ref.	Medida (mm)	Utilizar em (mm)	Preço
W77H01	480	24~30	22.50€
W77H02	610	32~41	34.70€
W77H03	760	46~55	60.20€
W77H04	860	60~65	76.50€

WFS46

29.60€

Chave para filtro diferencial

Inclui chave hexagonal de 5mm

Medida: 46mm

Estrado de 12 faces

Aplicação: VW: Bora, Golf IV, Sharan

Skoda: Octavia

W67

Chave de boca pancada

Ref.	Medida (mm)	Comp. (mm)	Preço
W67119	19	177	5.20€
W67121	21	177	5.30€
W67124	24	197	6.40€
W67130	30	243	10.20€
W67132	32	273	13.00€
W67136	36	299	18.50€
W67138	38	299	18.90€
W67141	41	339	25.00€
W67146	46	374	30.00€
W67150	50	417	42.00€
W67155	55	496	57.00€
W67160	60	496	58.00€
W67165	65	496	59.00€
W67170	70	496	99.00€

W72

Chave de luneta pancada



Ref.	Medida (mm)	Comp. (mm)	Preço
W72117	17	160	8.10€
W72118	18	160	8.30€
W72119	19	160	8.40€
W72121	21	160	8.60€
W72122	22	163	9.20€
W72124	24	163	9.25€
W72127	27	180	9.30€
W72130	30	190	13.30€
W72132	32	190	13.35€
W72134	34	205	18.40€
W72136	36	205	19.40€
W72141	41	230	23.50€
W72146	46	240	30.50€
W72150	50	255	40.80€
W72155	55	360	55.00€
W72170	70	335	127.50€

W27AR

Chave inglesa



Ref.	Abertura (mm)	Comp. (mm)	Preço
W27AR8	26,9	200	24.50€
W27AR10	34	250	30.60€



ON: funciona como roquete

OFF: funciona como chave inglesa

W27AS

Chave inglesa



Ref.	Abertura (mm)	Comp. (mm)	Preço
W27AS8	20	150	13.50€
W27AS10	29	250	16.20€
W27AS15	43	380	43.50€
W27AS18	53	450	70.00€

W27AT

Chave ajustável com cabo antideslizante



Ref.	Medida (mm)	Comp. (mm)	Preço
W27AT8	24	200	19.00€
W27AT10	29	250	23.00€
W27AT12	34	300	27.70€
W27AT15	43	375	53.50€



Ferramenta de aperto
Ferramenta SUPERTECH
W27AK8

28.50€

Chave inglesa duplo sistema (métrico/SAE)

Comprimento: 200mm

W28HD

Chave bico de falcão para tubos

Ref.	Abertura (mm)	Comp. (mm)	Preço
W28HD8	10-22	200	29.50€
W28HD10	12-30	250	33.50€

W28

Chave para tubos

Ref.	Abertura (mm)	Comp. (mm)	Preço
W2808	25,5	200	15.20€
W2810	38	250	16.80€
W2812	51	300	22.00€
W2814	51	350	26.00€
W2818	63,5	450	39.30€
W2824	76	600	63.50€
W2836	127	900	143.00€

W28RJ-HL

Garras de substituição

Ref.	Aplicável modelo	Preço
W2810RJ-HL	W2810	5.40€
W2812RJ-HL	W2812	6.50€
W2814RJ-HL	W2814	7.15€
W2818RJ-HL	W2818	9.60€
W2824RJ-HL	W2824	14.00€
W2836RJ-HL	W2836	26.70€

S68H2141S

49.90€

Jogo de 41 peças de 1/4" SUPERTECH

Composição/ medidas em mm:

R2902 Roquete de 36 dentes
 Chaves caixa: 4; 4,5; 5; 5,5; 6; 7; 8; 9; 10; 11; 12; 13 e 14
 Chaves hexagonais: 1,5; 2 e 2,5
 20 Bits
 Extensão de 50
 Cabo "T" correção
 Adaptador hexagonal
 Punho

S68H4127S

116.00€

Jogo de 27 peças de 1/2" SUPERTECH

Composição/ medidas em mm:

R2904 Roquete de 36 dentes
 Chaves caixa: 8 a 24; 27; 30 e 32
 Chaves de velas: 16 e 21
 Cardan
 Extensão de 125 e 250
 Cabo "T" correção

S68H

Chave de caixa 1/4" SUPERTECH

Ref.	Medida (mm)	SAE	Torque	Preço
S68H2103	3	1/8"	E4	0.75€
S68H2104	4	5/32"	E5	0.75€
S68H21045	4,5			0.80€
S68H2105	5	3/16"	E6	0.80€
S68H21055	5,5	7/32"	E7	0.80€
S68H2106	6		E8	0.85€
S68H21065	6,5	1/4"	E8	0.85€
S68H2107	7	9/32"		0.85€
S68H2108	8	5/16"	E10	0.90€
S68H2109	9	11/32"	E11	0.90€
S68H2110	10	3/8"	E12	0.90€
S68H2111	11	7/16"	E14	0.95€
S68H2112	12	15/32"		0.95€
S68H2113	13	1/2"	E16	0.95€
S68H2114	14	9/16"	E18	1.15€



S68H5234111S

295.00€

Jogo de 111 peças de 1/4", 3/8" e 1/2" **SUPERTECH**

Composição/ medidas em mm:

- R3702 Roquete de 1/4"
- R3703 Roquete de 3/8"
- R3704 Roquete de 1/2"
- Chaves caixa de 1/4": 3,2 a 13
- Chaves caixa de 3/8": 9 a 19
- Chaves caixa de 1/2": 14 a 32
- Chaves de velas de 3/8": 14 e 18
- Chaves de velas de 1/2": 16 e 21
- Chaves hexagonais: 1,5; 2 e 2,5
- Chaves mistas boca/ luneta: 8 a 19
- Bits de 1/4" fenda/ phillips/ torx/ hexagonal/ pozi
- Bits de 5/16" fenda/ phillips/ torx/ hexagonal/ pozi
- Adaptador bits 5/16"
- Cardan de 1/4"; 3/8" e 1/2"
- Extensões de 1/4" com 50 e 150
- Extensões de 3/8" com 75 e 150
- Extensões de 1/2" com 125 e 250
- Adaptador "T" para extensões
- Punho



W84108S

55.00€

Jogo de 8 chaves mistas boca/ luneta **SUPERTECH**

Chaves: 8; 10; 11; 12; 13; 14; 17 e 19mm



W84114S

82.50€

Jogo de 14 chaves mistas boca/ luneta **SUPERTECH**

Chaves: 6 a 19mm

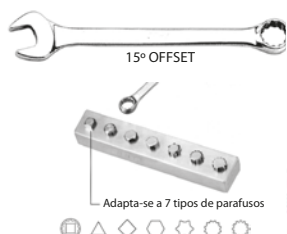

Ferramenta de aperto

Ferramenta SUPERTECH

W84



Chave mista boca/ luneta **SUPERTECH**

Ref.	Medida (mm)	Preço
W84106	6	3.90€
W84107	7	4.00€
W84108	8	4.10€
W84109	9	4.30€
W84110	10	4.60€
W84111	11	4.80€
W84112	12	5.10€
W84113	13	5.60€
W84114	14	5.80€
W84115	15	6.60€
W84116	16	7.15€
W84117	17	7.70€
W84118	18	8.15€
W84119	19	9.15€

W86112S

193.00€

Jogo de 12 chaves boca/ roquete **SUPERTECH**

Chaves: 8 a 19mm



S03H2327S

59.50€

Jogo de chaves e bits de caixa de 1/4" com 27 peças

Composição/ medidas em mm:

- Chave mista boca/roquete
- Mini chaves 13mm: 4; 4,5; 5; 5,5; 6; 7; 8; 9; 10; 11; 12; 13 e 14
- Bits caixa hexagonais: 3; 4; 5 e 6mm
- Bits caixa phillips: PH1; Ph2 e Ph3
- Bits caixa fenda: 5,5 e 7mm
- Cardan
- Extensão 50mm
- Cabo "T" correção 115mm



S04H2118S

33.50€

Jogo de chaves de caixa de 1/4" com 18 peças

Composição/ medidas em mm:

- R2902 Roquete de 36 dentes
- S04H2 Chaves caixa: 4; 4,5; 5; 5,5; 6; 7; 8; 9; 10; 11; 12 e 13
- S24H2 Extensões de 2" e 4"
- S23H2 Cabo "T" corrediço
- S15H240 Adaptador universal
- S22H2130 Punho flexível

S04H2141S

65.00€

Jogo de chaves de caixa de 1/4" com 41 peças

Composição/ medidas em mm:

- R3702 Roquete de 48 dentes
- S04H2 Chaves caixa: 4; 5; 5,5; 6; 7; 8; 10; 11; 12 e 13
- S04HD2 Chaves longas de caixa: 7; 8 e 10
- Chaves macho hexagonais: 1,5; 2; 2,5 e 3
- S09H2 Bits hexagonais: 3; 4; 5 e 6
- S07H2 Bits torx: T10; T20; T25; T27; T30 e T40
- S10H2 Bits fenda: 0,8x4; 10x5,5 e 1,2x7
- S11H2 Bits phillips: PH1; PH2 e PH3
- S24H Extensões de 2" e 6"
- S28H1 Punho
- S15H240 Adaptador universal
- S27H2150 Extensão flexível 6"
- S16H3814 Adaptador 3/8 (F) x 1/4" (M)
- Caixa metálica

S04H3125S

67.50€

Jogo de chaves de caixa de 3/8" com 25 peças

Composição/ medidas em mm:

- R3703 Roquete de 48 dentes
- Chaves caixa: 6 a 22
- Chaves de velas: 16 e 21
- S24H Extensões de 75 e 150
- S23H31200 Cabo "T" corrediço de 200
- S15H356 Cardan
- Caixa metálica

S04H3141S

109.00€

Jogo de chaves de caixa de 3/8" com 40 peças

Composição/ medidas em mm:

- R3703 Roquete de 48 dentes
- S04H3 Chaves caixa: 6 a 24
- Chaves de caixa longas: 14; 15; 17 e 19
- Bits torx: T10; T20; T25; T27; T30; T40; T45 e T50
- Bits fenda: 0,8x4; 1x5,5 e 1,2x8
- Bits phillips: PH1; PH2 e PH3
- 2 Extensões
- Cardan
- Adaptador universal
- Mala de transporte

S04H3157S

125.00€

Jogo de chaves de caixa de 1/4" e 3/8" com 56 peças

Composição/ medidas em mm:

- R3702 Roquete 1/4" de 48 dentes
- R3703 Roquete 3/8" de 48 dentes
- S04H2 Chaves de 1/4": 4; 4,5; 5; 5,5; 6; 7; 8; 9; 10; 11; 12 e 13
- S04HD2 Chaves longas de 1/4": 8; 10; 12; e 13
- S04H3 Chaves de 3/8": 14; 15; 17; 18; 19; 20; 22 e 24
- S04HD3 Chaves longas 3/8": 14; 15; 17
- S17H3 Chaves velas 3/8": 16 e 21
- S09H2 Bits hexagonais: 3; 4; 5 e 6
- S07H2 Bits torx: T10; T15; T20; T25; T27 e T30
- S10H2 Bits fenda: 4; 5,5 e 7
- S11H2 Bits phillips: PH1; PH2 e PH3
- S24H2 2 Extensões
- S24H3 2 Extensões
- S16H302 Adaptador universal
- Adaptador de extensão 1/4" - 3/8"
- S15H356 Adaptador universal
- Adaptador de extensão 1/4" - 1/2"
- Punho

S04H3536S

97.00€

Jogo de chaves de caixa de 3/8" com 36 peças

Composição/ medidas em mm:

- R3503 Roquete de 72 dentes
- Chaves caixa: 6 a 22mm
- Chaves mistas: 7 a 17mm
- Chaves de velas: 16 e 21mm
- Extensões de 75; 150 e 225mm
- Cardan
- S16H403 Adaptador
- Caixa metálica



S04H4125S
88.00€
Jogo de chaves de caixa de 1/2" com 25 peças

Composição/ medidas em mm:

- R3704 Roquete de 48 dentes
- S04H4 Chaves caixa: 10 a 24; 27; 30 e 32
- Chaves de velas: 16 e 21
- Extensões de 5" e 10"
- Cabo "T" corrediço
- Adaptador universal
- Mala de transporte

S04H4524S
98.00€
Jogo de chaves de caixa de 1/2" com 24 peças

Composição/ medidas em mm:

- R3704 Roquete de 48 dentes
- S04H4 Chaves caixa: 10 a 24; 27; 30 e 32
- S24H4 Extensões de 5" e 10"
- S23H41300 Cabo "T" corrediço
- S15H472 Adaptador universal
- S22H41375 Punho flexível 15"
- Caixa metálica

S04H4728S
97.00€
Jogo de chaves de caixa sextavadas de 1/2" com 28 peças

Composição/ medidas em mm:

- R3704 Roquete de 48 dentes
- S04H4 Chaves caixa: 8 a 28; 30; 32 e 34
- S24H4250 Extensão 10"
- S23H41300 Cabo "T" corrediço
- S15H472 Adaptador universal
- Caixa metálica

S04H6115S
157.00€
Jogo de chaves de caixa de 3/4" com 14 peças

Composição/ medidas em mm:

- Roquete
- Chaves caixa: 22; 24; 27; 30; 32; 36; 38; 41; 46 e 50
- Extensão de 100 e 200
- Cabo "T" corrediço

S04H6321S
258.00€
Jogo de chaves de caixa de 3/4" com 20 peças

Composição/ medidas em mm:

- R1206N Roquete reversível de 500
- S04H61 Chaves caixa: 19; 21; 22; 24; 27; 30; 32; 36; 38; 41; 46 e 50
- S24H6 Extensão de 100; 200 e 400
- S22H6475 Cabo articulado 475
- S16H3412 Adaptador 3/4"F para 1/2"M
- S16H3410 Adaptador 3/4"F para 1"M
- S15H6109 Adaptador universal
- Mala de transporte

S04H8115S
505.00€
Jogo de chaves de caixa de 1" com 14 peças

Composição/ medidas em mm:

- Roquete
- Chaves caixa: 36; 41; 46; 50; 55; 60; 65; 70; 75 e 80
- Extensão de 200 e 400
- Cabo de 550

S06H425S
44.50€
Jogo de 25 bits torx de 1/2" e 1/4"

Composição/ medidas em mm:

- S07H2 Bits torx de 1/4": T8; T10; T15; T20; T25; T27 e T30x32
- S07H3 Bits torx de 1/2": T40; T45; T50; T55 e T60x55
- S06H2 Chaves parafusos torx 1/4": E4; E5; E6; E7 e E8
- S06H4 Chaves parafusos torx 1/2": E10; E11; E12; E14 e E18
- H08 Chaves macho torx: T6; T8 e T10

S06H4127S
92.50€
Jogo de 27 bits de 1/2" e 3/8"

Composição/ medidas em mm:

- S09H4 Bits hexagonais de 1/2": 4; 5; 6; 7; 8; 10 e 12x55; 14x60; 17x70; 8x80 e 10x140
- S49H4 Bits estriados de 1/2": M5; M6; M8; M10; M12; M14; M16x55; M10; M12x110 e M8x120
- S09H3 Bits hexagonais de 3/8": 4; 5; 6; 7; 8 e 10x48



S07H4109S

28.00€

Jogo de 9 chaves bits torx de 1/2"

Composição:

T20; T25; T27; T30; T40; T50; T55 e T60



S07H4932S

115.00€

Jogo de 32 chaves bits torx de 1/2"

Composição:

Bits 55mm: T20; T25; T27; T30; T40; T45; T50; T55; T60 e T70

Bits 100mm: T20; T25; T27; T30; T40; T45; T50; T55; T60 e T70

Bits 140mm: T40; T45; T50; T55; T60 e T70

Bits 200mm: T40; T45; T50; T55; T60 e T70

Mala de transporte



S09H4109S

30.50€

Jogo de 9 chaves bits hexagonais de 1/2"

Composição:

H3; H4; H5; H6; H7; H8; H10; H12 e H14



S63H4132S

112.00€

Jogo de 32 chaves bits de 6 caneluras (Ribe) 1/2"

Composição:

Bits 55mm: M5; M6; M7; M8; M9; M10; M12; M13 e M16

Bits 100mm: M5; M6; M7; M8; M9; M10; M12; M13 e M16

Bits 140mm: M8; M9; M10; M12; M13 e M14

Bits 200mm: M8; M9; M10; M12; M13 e M14

Mala de transporte



S64H4126S

94.00€

Jogo de 26 chaves bits ZXN 1/2"

Composição:

Bits 55mm: M5; M6; M8; M10; M12; M14 e M16

Bits 100mm: M5; M6; M8; M10; M12 e M14

Bits 140mm: M5; M6; M8; M10; M12 e M14

Bits 200mm: M8; M10; M12 e M14

Mala de transporte



S04H52460S

137.00€

Jogo de 60 peças de ferramenta de 1/2" e 1/4"

Composição/ medidas em mm:

Roquete 1/2" de 36 dentes

Chaves caixa 1/2": 12; 13; 14; 15; 17; 18; 19; 22 e 24

Chaves caixa 1/4": 6; 8; 9; 10; 11; 12 e 13

Chaves de velas 1/2": 16 e 21

Chaves mistas: 8; 10; 12; 13; 14 e 17

Jogo de chaves fenda/ phillips

Bits de 1/4": fenda, torx e phillips

Porta bits de 1/4"

Extensões 1/2" de 125 e 250

Extensão 1/4" com 75

Extensão flexível de 1/4"

Adaptador 3/8"F para 1/2"M

Cabo "T" correção 1/4"

Alicate ajustável

Alicate universal

Pontas de 1/4"

Martelo

Cardan de 1/2"

Punho de 1/4"



S04H52477S

179.00€

Jogo de 77 peças de ferramenta de 1/2" e 1/4"

Composição/ medidas em mm:

R2904	Roquete 1/2" reversível de 36 dentes
R2902	Roquete 1/4" reversível de 36 dentes
S04H4	Chaves caixa 1/2": 12 a 32
S04H21	Chaves caixa 1/4": 4 a 12
S04HD21	Chaves de caixa longas 1/4": 8; 10; 12 e 13
S17H	Chaves de velas 1/2": 16 e 21mm
W26	Chaves boca/ luneta: 8; 10; 12; 13; 14; 15; 17 e 19
D04	Jogo de chaves fenda
S24H	Extensões 1/2" de 125 e 250
S24H275	Extensão 1/4" com 75
S15H472	Adaptador universal 1/2"
S15H240	Adaptador universal 1/4"
S16H304	Adaptador 3/8"F para 1/2"M
S23H21130	Cabo "T" correção 1/4"
P2810	Alicate ajustável
P088	Alicate universal
	Pontas de 1/4"
M09500	Martelo de mecânico tipo "Alemão" 500g
	Mala de transporte



S04H52478S

215.00€

Jogo de 78 peças de ferramenta de 1/2" e 1/4"

Composição/ medidas em mm:

	Roquete 1/2" de 48 dentes
	Roquete 1/4" de 48 dentes
	Chaves caixa 1/4": 5 a 11
	Chaves caixa longas 1/4": 5 a 12
	Chaves de velas 1/2": 16 e 21
	Chaves caixa 1/2": 12 a 19; 22; 24; 27 e 32
	Chaves mistas: 6 a 17; 19, 21; 22 e 24
	Chaves allen hexagonais: 2,5 a 10
	Chaves allen torx: T10; T15; T20; T25; T27; T30 e T40
	Chaves luneta aberta: 8x10; 11x13; 12x14 e 17x19
	Jogo de chaves fenda/ phillips
	Extensões 1/2" de 125 e 250
	Extensão 1/4" com 50
	Adaptador 3/8"F para 1/2"M
	Cabo "T" correção 1/4"
	Alicate de pressão
	Cardan de 1/2" e 1/4"
	Punho de 1/4"



S04H524127S

370.00€

Jogo de 127 peças de ferramenta de 1/2" e 1/4"

Composição/ medidas em mm:

- R2904 Roquete 1/2" reversível de 36 dentes
- R2902 Roquete 1/4" reversível de 36 dentes
- Chaves caixa 1/2": 8 a 11; 13 a 19; 21; 22; 24; 27; 30 e 32
- Chaves caixa 1/4": 4; 4,5; 5; 5,5; 6 a 13
- Chaves caixa longa 1/2": 10; 12; 13; 14; 15; 17 e 19
- Chaves caixa longa 1/4": 7; 8; 10; 12 e 13
- Chaves de velas 1/2": 16 e 21
- Chaves caixa torx 1/4": E4; E5; E6; E7 e E8
- Chaves torx 1/2": E10; E12; E14; E16; E18; E20; E22 e E24
- Chaves mistas: 6 a 17; 19; 21; 22; 24; 27; 30 e 32
- Chaves luneta aberta: 8x10; 9x11; 12x13; 14x17 e 17x19
- Chaves hexagonais curtas: 1,5; 2; 2,5; 3; 4; 5; 6; 8 e 10
- Chaves torx: T10; T15; T20; T25; T27; T30 e T40
- Chaves fendas com punho antideslizante
- Chaves phillips com punho antideslizante
- Jogo de punções e escopros
- S21H Extensões 1/4" de 50x150 e de 1/2" 50mm
- S24H Extensões 1/2" de 125 e 250 e de 1/4" de 75
- Extensão flexível 1/4" de 145
- Cabo "T" correção 1/4" de 130 e 1/2" de 250
- Cabo articulado 1/2" de 375
- P2810 Alicates ajustáveis
- P8606 Alicates de corte
- P8007 Alicates universais
- AG010034 Caneta magnética
- M09500 Martelo de mecânico tipo "Alemão" 500g
- Cardan de 1/2" e 1/4"
- Mala de transporte



S04H624101S

250.00€

Jogo de 101 peças de ferramenta de 1/2" e 1/4"

Composição/ medidas em mm:

- R2904 Roquete 1/2" reversível de 36 dentes
- R2902 Roquete 1/4" reversível de 36 dentes
- S04H4 Chaves caixa sextavadas 1/2": 8 a 24; 27; 30 e 32
- S04H2 Chaves caixa sextavadas 1/4": 4; 4,5; 5; 5,5; 6; 7; 8; 9 e 10
- S17H4 Chaves de velas 1/2": 16 e 21
- S06H4 Chaves caixa torx 1/2": E11; E12; E14; E16 e E18
- W24 Chaves luneta aberta: 8x10; 11x13; 12x14 e 17x19
- W26 Chaves boca/ luneta: 8; 10 a 19; 21; 22 e 24
- D04 Jogo de chaves fenda
- S24H4 Extensões 1/2" de 125 e 250
- S21H4 Extensão 1/2" de 50
- S24H2 Extensões 1/4" de 75 e 100
- S27H4 Extensão flexível 1/4"
- S14H4 Adaptador universal 1/2"
- S15H2 Adaptador universal 1/4"
- S23H2 Cabo "T" correção 1/4"
- S23H4 Cabo "T" correção 1/2"
- W27AS8 Alicates ajustáveis
- P087 Alicates universais
- AG010034 Caneta magnética
- Pontas de 1/4"
- Pontas XZN - M6; M8; M10 e M12
- Mala de transporte



S04H21

Chave de caixa sextavada 1/4"

Ref.	Medida (mm)	D1 (mm)	D2 (mm)	L (mm)	Preço
S04H2104	4	11,8	6,8	25	0.75€
S04H21045	4,5	11,8	7,3	25	0.75€
S04H2105	5	11,8	8	25	0.75€
S04H21055	5,5	11,8	8,6	25	0.80€
S04H2106	6	11,8	9,2	25	0.80€
S04H2107	7	11,8	10,5	25	0.80€
S04H2108	8	11,4	11,7	25	0.85€
S04H2109	9	11,6	12,7	25	0.90€
S04H2110	10	12,8	13,7	25	0.90€
S04H2111	11	14,4	15,7	25	0.95€
S04H2112	12	13,7	16,6	25	0.95€
S04H2113	13	13,9	17,6	25	1.00€
S04H2114	14	17,5	20	25	1.10€

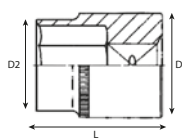
S04HD21

Chave de caixa sextavada longa 1/4"

Ref.	Medida (mm)	D1 (mm)	D2 (mm)	L (mm)	Preço
S04HD2106	6	12	9,2	50	1.25€
S04HD2107	7	12	10,5	50	1.30€
S04HD2108	8	11,5	12	50	1.35€
S04HD2110	10	13,3	14,4	50	1.40€
S04HD2111	11	14,8	15,9	50	1.45€
S04HD2112	12	15,8	17	50	1.55€
S04HD2113	13	16,8	17,8	50	1.65€

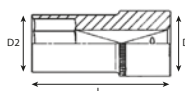
S04H31

Chave de caixa sextavada 3/8"

Ref.	Medida (mm)	D1 (mm)	D2 (mm)	L (mm)	Preço
S04H3106	6	16,8	9,6	28	1.05€
S04H3107	7	16,8	10,7	28	1.05€
S04H3108	8	16,8	12	28	1.05€
S04H3109	9	16,8	13,3	28	1.05€
S04H3110	10	16,8	14,4	28	1.05€
S04H3111	11	16,8	15,8	28	1.10€
S04H3112	12	16	16,8	28	1.10€
S04H3113	13	18	19	28	1.10€
S04H3114	14	18,8	19,7	28	1.10€
S04H3115	15	19,8	20,8	28	1.15€
S04H3116	16	20,8	22	28	1.20€
S04H3117	17	22	23,8	28	1.35€
S04H3118	18	24,1	25,7	28	1.45€
S04H3119	19	24,1	25,7	28	1.50€
S04H3120	20	25	27,6	32	1.65€
S04H3121	21	25	27,6	32	1.75€
S04H3122	22	27,8	29,6	32	1.85€
S04H3124	24	29,8	31	32	1.95€

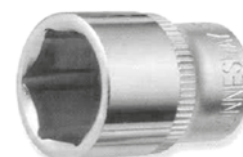
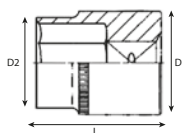

S04HD31

Chave de caixa sextavada longa 3/8"

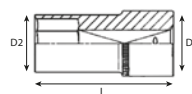

Ref.	Medida (mm)	D1 (mm)	D2 (mm)	L (mm)	Preço
S04HD3109	9	16,8	13,3	63	1.85€
S04HD3110	10	17	14,4	63	1.85€
S04HD3111	11	17	15,8	63	1.90€
S04HD3112	12	17	17,7	63	1.95€
S04HD3113	13	18	19	63	2.00€
S04HD3114	14	18,8	19,7	63	2.05€
S04HD3115	15	19,8	20,8	63	2.15€
S04HD3116	16	20,8	22	63	2.20€
S04HD3117	17	22,8	23,8	63	2.25€
S04HD3119	19	23,8	26	63	2.55€
S04HD3120	20	24,8	27,8	63	3.00€
S04HD3121	21	25,8	28	63	3.05€



S04H41

Chave de caixa sextavada 1/2"

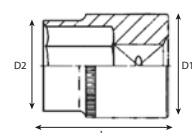

Ref.	Medida (mm)	D1 (mm)	D2 (mm)	L (mm)	Preço
S04H4108	8	21,8	13,8	38	1.35€
S04H4109	9	21,8	14,3	38	1.35€
S04H4110	10	21,8	15,4	38	1.35€
S04H4111	11	21,8	16,7	38	1.40€
S04H4112	12	21,8	18	38	1.40€
S04H4113	13	21,8	19	38	1.40€
S04H4114	14	22	20,3	38	1.45€
S04H4115	15	22	21,3	38	1.50€
S04H4116	16	22	23,3	38	1.55€
S04H4117	17	23	23,8	38	1.60€
S04H4118	18	23,5	24,8	38	1.65€
S04H4119	19	24	27	38	1.75€
S04H4120	20	24	28	38	2.05€
S04H4121	21	24	29	38	2.15€
S04H4122	22	28	30	38	2.25€
S04H4123	23	28	30,7	38	2.45€
S04H4124	24	28	31,8	38	2.55€
S04H4125	25	28	33,8	38	2.85€
S04H4126	26	30	34	42	2.95€
S04H4127	27	28	35,7	42	3.05€
S04H4128	28	30	38	42	3.25€
S04H4129	29	32	38	42	3.55€
S04H4130	30	34	39,8	42	3.65€
S04H4132	32	36	42	42	3.95€
S04H4134	34	40	45	48	5.20€
S04H4136	36	41	48	48	6.50€



S04HD41

Chave de caixa sextavada longa 1/2"

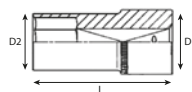

Ref.	Medida (mm)	D1 (mm)	D2 (mm)	L (mm)	Preço
S04HD4109	12	21,8	12,7	76	2.95€
S04HD4110	10	21,8	15,4	76	3.00€
S04HD4111	11	21,8	16,7	76	3.05€
S04HD4112	12	21,8	18	76	3.05€
S04HD4113	13	21,8	19	76	3.10€
S04HD4114	14	22	20,3	76	3.15€
S04HD4115	15	22	21,3	76	3.25€
S04HD4116	16	22	23	76	3.30€
S04HD4117	17	23	23,8	76	3.35€
S04HD4118	18	23	24,8	76	3.45€
S04HD4119	19	24	25,8	76	3.50€
S04HD4120	20	24	28	76	3.55€
S04HD4121	21	24	29	76	3.60€
S04HD4122	22	26	30	76	3.75€
S04HD4123	23	28	31,8	76	3.85€
S04HD4124	24	28	31,8	76	3.95€
S04HD4125	25	28	33,8	76	5.30€
S04HD4126	26	28	33,8	76	5.60€
S04HD4127	27	28	35,7	76	6.10€
S04HD4128	28	30	38	76	6.30€
S04HD4130	30	34	39,8	76	7.15€
S04HD4132	32	36	42	76	7.35€

S04HD4115

40.50€

Jogo de 10 chaves de caixa longas de 1/2" - 6 faces

Composição:

S04HD4 Chaves: 10; 11; 13; 14; 15; 17; 19; 21; 22 e 24mm

S04H61

Chave de caixa sextavada 3/4"

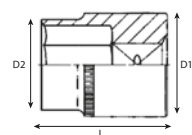

Ref.	Medida (mm)	D1 (mm)	D2 (mm)	L (mm)	Preço
S04H6119	19	30	36	49,5	4.85€
S04H6121	21	32	36	49,5	4.90€
S04H6122	22	33	36	49,5	4.90€
S04H6124	24	35	36	49,5	4.95€
S04H6127	27	38	36	52	4.95€
S04H6128	28	39	36	52	5.00€
S04H6130	30	42	38	54	5.80€
S04H6132	32	44	38	56	6.10€
S04H6134	34	46	38	58	7.00€
S04H6136	36	50	42	58	7.60€
S04H6138	38	52	45	60	8.00€
S04H6141	41	56	45	64	8.80€
S04H6146	46	62	48	68	10.70€
S04H6150	50	68	48	72	11.80€
S04H6152	52	69	48	73	17.00€



S04H63

Chave de caixa 3/4" - 12 faces

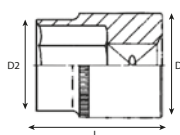

Ref.	Medida (mm)	D1 (mm)	D2 (mm)	L (mm)	Preço
S04H6319	19	30	36	49,5	4.80€
S04H6321	21	32	36	49,5	4.90€
S04H6322	22	33	36	49,5	4.95€
S04H6323	23	34	36	49,5	5.00€
S04H6324	24	35	36	49,5	5.10€
S04H6325	25				5.60€
S04H6326	26				5.70€
S04H6327	27	38	36	52	5.90€
S04H6329	29	40	38	53	6.00€
S04H6330	30	42	38	54	6.40€
S04H6332	32	44	38	56	6.60€
S04H6334	34	46	38	58	7.00€
S04H6336	36	50	42	58	7.70€
S04H6338	38	52	45	60	8.10€
S04H6341	41	56	45	64	9.50€
S04H6346	46	62	48	68	11.20€
S04H6350	50	68	48	72	12.90€
S04H6355	55	74	48	76	17.40€
S04H6356	56	75	48	76	17.50€
S04H6360	60	70	48	78	19.60€
S04H6365	65	87	60	85	26.00€



S04H64

Chave de caixa 3/4" - 12 faces (em polegadas)

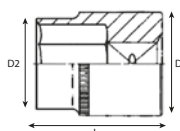

Ref.	Medida	D1 (mm)	D2 (mm)	L (mm)	Preço
S04H6419	3/4"	30	36	49,5	5.50€
S04H6421	13/16"	32	36	49,5	5.50€
S04H6422	7/8"	33	36	49,5	5.50€
S04H6424	15/16"	34	36	49,5	5.55€
S04H6426	1"	35	36	49,5	5.60€
S04H6427	1-1/16"	38	36	52	5.70€
S04H6429	1-1/18"	40	38	53	6.00€
S04H6430	1-3/16"	42	38	54	6.05€
S04H6432	1-1/4"	44	38	56	6.10€
S04H6433	1-5/16"	46	38	56	6.20€
S04H6435	1-3/8"	48	42	58	7.30€
S04H6436	1-7/16"	50	42	58	7.40€
S04H6438	1-1/2"	52	45	60	8.10€
S04H6440	1-9/16"	52	45	60	8.90€
S04H6441	1-5/8"	56	45	64	8.90€
S04H6443	1-11/16"	56	45	64	9.50€
S04H6444	1-3/4"	56	45	64	9.80€
S04H6446	1-13/16"	62	48	68	10.30€
S04H6447	1-7/8"	62	48	68	13.00€
S04H6450	2"	68	48	72	13.10€
S04H6456	2/14"	75	48	76	17.50€



S04H83

Chave de caixa 1" - 12 faces

Ref.	Medida (mm)	D1 (mm)	D2 (mm)	L (mm)	Preço
S04H8355	55	76	57	80	23.30€
S04H8360	60	82	57	84	28.50€
S04H8365	65	88	57	87	33.00€

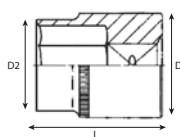
S05H4113S

29.80€

Jogo de 13 chaves de caixa de 1/2" - 12 faces

Composição:

S05H4 Chaves: 10; 12; 13; 14; 15; 16; 17; 18; 19; 20; 21; 22 e 24mm

S05H4213S

37.50€

Jogo de 13 chaves de caixa de 1/2" SAE

Composição:

Chaves: 3/8"; 7/16"; 1/2"; 9/16"; 5/8"; 11/16"; 3/4"; 13/16"; 7/8"; 15/16"; 1"; 1-1/16" e 1-1/8"

S05HD41

Chave de caixa sextavada longa 1/2"

Ref.	Medida (mm)	D1 (mm)	D2 (mm)	L (mm)	Preço
S05HD4110	10	21,8	15,4	76	3.00€
S05HD4111	11	21,8	16,7	76	3.05€
S05HD4112	12	21,8	18	76	3.10€
S05HD4113	13	21,8	19	76	3.15€
S05HD4117	17	23,8	23,8	76	3.30€
S05HD4118	18	24,8	16,7	76	3.40€
S05HD4119	19	25,8	25,8	76	3.60€
S05HD4120	20	27,9	27,9	76	3.70€
S05HD4121	21	27,9	27,9	76	3.80€
S05HD4122	22	30	30	76	3.90€
S05HD4123	23	31,8	31,8	76	4.50€
S05HD4124	24	31,8	31,8	76	5.40€
S05HD4127	27	36	36	76	6.20€
S05HD4130	30	40	40	76	6.95€
S05HD4132	32	42	42	76	7.35€

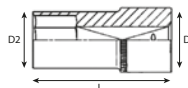
S05HD4113S

59.00€

Jogo de 13 chaves de caixa longas 1/2" - 6 faces

Composição:

S05HD4 Chaves: 11; 13; 14; 15; 17; 19; 21; 22; 23; 24; 27; 30 e 32mm

S06H37S

14.90€

Jogo de 7 chaves de caixa para parafusos torx 3/8"

Composição:

S06H3 Chaves: E10; E11; E12; E14; E16; E18 e E20

S05HD4213S

48.50€

Jogo de 13 chaves de caixa longas 1/2" SAE

Composição:

Chaves: 7/16"; 1/2"; 9/16"; 5/8"; 11/16"; 3/4"; 13/16"; 7/8"; 15/16"; 1"; 1-1/16"; 1-1/8" e 1-1/4"

S06H49S

23.50€

Jogo de 9 chaves de caixa para parafusos torx 1/2"

Composição:

S06H4 Chaves: E10; E11; E12; E14; E16; E18; E20; E22 e E24



Ferramenta de aperto

S66H41

Chaves de caixa de 1/2" - 12 faces

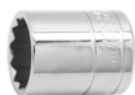

Ref.	Medida (mm)	Preço
S66H4108	8	1.35€
S66H4110	10	1.45€
S66H4111	11	1.50€
S66H4112	12	1.50€
S66H4113	13	1.55€
S66H4114	14	1.55€
S66H4115	15	1.55€
S66H4116	16	1.60€
S66H4117	17	1.60€
S66H4118	18	1.75€
S66H4119	19	1.75€
S66H4120	20	1.95€
S66H4121	21	2.25€
S66H4122	22	2.55€
S66H4124	24	3.20€
S66H4125	25	3.55€
S66H4126	26	3.80€
S66H4127	27	4.00€
S66H4128	28	4.20€
S66H4130	30	4.60€
S66H4132	32	5.60€
S66H4136	36	7.45€

S66HD41

Chaves de caixa longas de 1/2" - 12 faces



Ref.	Medida (mm)	Preço
S66HD4110	10	2.35€
S66HD4111	11	2.35€
S66HD4112	12	2.40€
S66HD4113	13	2.40€
S66HD4114	14	2.45€
S66HD4115	15	2.55€
S66HD4116	16	2.55€
S66HD4117	17	2.60€
S66HD4118	18	2.65€
S66HD4119	19	2.75€
S66HD4120	20	2.90€
S66HD4121	21	2.95€
S66HD4122	22	3.35€
S66HD4123	23	3.45€
S66HD4124	24	3.55€
S66HD4127	27	4.60€
S66HD4130	30	5.60€
S66HD4132	32	6.10€



 PHILLIPS	 FENDA	 TORX	 TORX TEMP.	 HEXAGONAL	 XZN
--	---	--	--	---	---

S06H2

Chave de caixa torx 1/4"

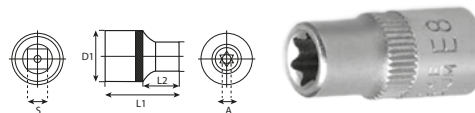

Ref.	Medida	D1 (mm)	D2 (mm)	L1 (mm)	L2 (mm)	Preço
S06H204	E4	12	6,2	25	11	1.05€
S06H205	E5	12	7,2	25	11	1.05€
S06H206	E6	12	8,2	25	11	1.05€
S06H207	E7	12	9	25	11	1.10€
S06H208	E8	12	10,3	25	11	1.10€
S06H210	E10					1.15€
S06H211	E11					1.15€

S06H3

Chave de caixa torx 3/8"



Ref.	Medida	D1 (mm)	D2 (mm)	L1 (mm)	Preço
S06H306	E6	17	11,2	28	1.50€
S06H307	E7	17	11,2	28	1.50€
S06H308	E8	17	11,2	28	1.50€
S06H310	E10	17	13,2	28	1.50€
S06H311	E11	17	13,8	28	1.50€
S06H312	E12	17	14,8	28	1.50€
S06H314	E14	18	16,8	28	1.50€
S06H316	E16	20	18,8	28	1.50€
S06H318	E18	22	20,8	28	1.50€
S06H320	E20	24	22,8	28	1.70€

S06H4

Chave de caixa torx 1/2"



Ref.	Medida	D1 (mm)	D2 (mm)	L1 (mm)	L2 (mm)	Preço
S06H410	E10	22	13,2	38	17	2.05€
S06H411	E11	22	13,9	38	17	2.05€
S06H412	E12	22	15	38	17	2.10€
S06H414	E14	22	16,7	38	17	2.15€
S06H416	E16	22	18,8	38	17	2.15€
S06H418	E18	22	20,8	38	17	2.15€
S06H420	E20	22	23	38	17	2.20€
S06H422	E22	22	25	38	17	2.20€
S06H424	E24	22	27	38	17	2.55€

S07H2



Chave de caixa bit torx 1/4"



Ref.	Medida	L1 (mm)	L2 (mm)	L3 (mm)	L (mm)	D (mm)	d (mm)	Preço
S07H206	T6	13	19	25	37	12	10,8	1.05€
S07H207	T7	13	19	25	37	12	10,8	1.05€
S07H208	T8	13	19	25	37	12	10,8	1.05€
S07H209	T9	13	19	25	37	12	10,8	1.05€
S07H210	T10	13	19	25	37	12	10,8	1.05€
S07H215	T15	13	19	25	37	12	10,8	1.05€
S07H220	T20	13	19	25	37	12	10,8	1.05€
S07H225	T25	13	19	25	37	12	10,8	1.05€
S07H227	T27	13	19	25	37	12	10,8	1.05€
S07H230	T30	13	19	25	37	12	10,8	1.05€
S07H240	T40	13	19	25	37	12	10,8	1.05€



S07H3



Chave de caixa bit torx 3/8"

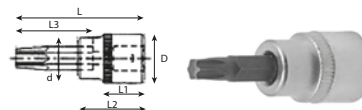

Ref.	Medida	L1 (mm)	L2 (mm)	L3 (mm)	L (mm)	D (mm)	d (mm)	Preço
S07H310	T10	16,5	26	30	48	18	13,8	1.15€
S07H315	T15	16,5	26	30	48	18	13,8	1.15€
S07H320	T20	16,5	26	30	48	18	13,8	1.15€
S07H325	T25	16,5	26	30	48	18	13,8	1.15€
S07H327	T27	16,5	26	30	48	18	13,8	1.15€
S07H330	T30	16,5	26	30	48	18	13,8	1.15€
S07H340	T40	16,5	26	30	48	18	13,8	1.15€
S07H345	T45	16,5	26	30	48	18	15,8	1.35€
S07H350	T50	16,5	26	30	48	18	15,8	1.35€
S07H355	T55	16,5	26	30	48	18	16,1	1.45€
S07H360	T60	16,5	26	30	48	18	16,1	1.55€

S07H4



Chave de caixa bit torx 1/2"



Ref.	Medida	L1 (mm)	L2 (mm)	L3 (mm)	L (mm)	D (mm)	d (mm)	Preço
S07H420	T20	20	38	30	55	22	15	2.15€
S07H425	T25	20	38	30	55	22	15	2.15€
S07H427	T27	20	38	30	55	22	15	2.15€
S07H430	T30	20	38	30	55	22	15	2.15€
S07H440	T40	20	38	30	55	22	15	2.15€
S07H445	T45	20	38	30	55	22	15	2.15€
S07H450	T50	20	38	30	55	22	15	2.25€
S07H455	T55	20	38	30	55	22	17	2.35€
S07H460	T60	20	38	30	55	24	22	2.45€
S07H470	T70	20	38	30	55	24	22	2.55€



S07H43

Chave de caixa bit torx 1/2"



Ref.	Medida	L1 (mm)	L2 (mm)	L3 (mm)	L (mm)	D (mm)	d (mm)	Preço
S07H4320	T20	20	38	75	100	24	15	3.05€
S07H4325	T25	20	38	75	100	24	15	3.05€
S07H4327	T27	20	38	75	100	24	15	3.05€
S07H4330	T30	20	38	75	100	24	15	3.15€
S07H4340	T40	20	38	75	100	24	15	3.15€
S07H4345	T45	20	38	75	100	24	15	3.15€
S07H4350	T50	20	38	75	100	24	15	3.15€
S07H4352	T52	20	38	75	100	24	15	3.25€
S07H4355	T55	20	38	75	100	24	17	3.25€
S07H4360	T60	20	38	75	100	24	22	3.45€
S07H4370	T70	20	38	75	100	24	22	3.55€

S07H45

Chave de caixa bit torx de 1/2"



Ref.	Medida	Comp. (mm)	Preço
S07H4530	T30	200	5.10€
S07H4540	T40	200	5.10€
S07H4545	T45	200	5.10€

S08H311S

Jogo de 11 bits de 1/4" e 3/8" torx tamperproof

12.50€

Composição:

Chaves de 1/4": T8; T10; T15; T20; T25 e T27

Chaves de 3/8": T30; T40; T45; T50 e T55

S09H2

Chave de caixa bit hexagonal 1/4"

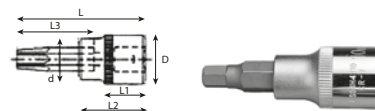

Ref.	Medida	L1 (mm)	L2 (mm)	L3 (mm)	L (mm)	D (mm)	d (mm)	Preço
S09H203	H3	13	19	25	37	12	10,8	1.05€
S09H204	H4	13	19	25	37	12	10,8	1.05€
S09H205	H5	13	19	25	37	12	10,8	1.05€
S09H206	H6	13	19	25	37	12	10,8	1.05€
S09H207	H7	13	19	25	37	12	10,8	1.05€

S09H3

Chave de caixa bit hexagonal 3/8"



Ref.	Medida	L1 (mm)	L2 (mm)	L3 (mm)	L (mm)	D (mm)	d (mm)	Preço
S09H303	H3	16,5	26	30	48	18	13,8	1.25€
S09H304	H4	16,5	26	30	48	18	13,8	1.25€
S09H305	H5	16,5	26	30	48	18	13,8	1.25€
S09H306	H6	16,5	26	30	48	18	13,8	1.25€
S09H307	H7	16,5	26	30	48	18	15,8	1.25€
S09H308	H8	16,5	26	30	48	18	15,8	1.35€
S09H310	H10	16,5	26	30	48	18	16,1	1.35€
S09H312	H12	16,5	26	30	48	18	16,1	1.55€
S09H314	H14	16,5	26	30	48	18	16,1	1.75€



S09H4



Chave de caixa bit hexagonal 1/2"



Ref.	Medida	L1 (mm)	L2 (mm)	L3 (mm)	L (mm)	D (mm)	d (mm)	Preço
S09H404	H4	20	38	30	55	24	15	2.25€
S09H405	H5	20	38	30	55	24	15	2.25€
S09H406	H6	20	38	30	55	24	15	2.25€
S09H407	H7	20	38	30	55	24	15	2.25€
S09H408	H8	20	38	30	55	24	15	2.25€
S09H410	H10	20	38	30	55	24	17,8	2.35€
S09H412	H12	20	38	30	55	24	22	2.55€
S09H414	H14	20	38	30	55	24	22	2.55€
S09H416	H16	20	38	30	55	24	22	2.75€
S09H417	H17	20	38	30	55	24	22	3.25€
S09H419	H19	20	38	30	55	24	22	3.65€



S09H43



Chave de caixa bit hexagonal 1/2"



Ref.	Medida	L1 (mm)	L2 (mm)	L3 (mm)	L (mm)	D (mm)	d (mm)	Preço
S09H4304	H4	20	38	75	100	24	15	3.05€
S09H4305	H5	20	38	75	100	24	15	3.05€
S09H4306	H6	20	38	75	100	24	15	3.10€
S09H4307	H7	20	38	75	100	24	15	3.10€
S09H4308	H8	20	38	75	100	24	15	3.10€
S09H4309	H9	20	38	75	100	24	15	3.15€
S09H4310	H10	20	38	75	100	24	20,8	3.25€
S09H4312	H12	20	38	75	100	24	22	3.45€
S09H4314	H14	20	38	75	100	24	22	3.50€
S09H4316	H16	20	38	75	100	24	22	4.10€
S09H4317	H17	20	38	75	100	24	22	4.70€
S09H4319	H19	20	38	75	100	24	22	6.35€

S10H2



Chave de caixa bit fenda 1/4"

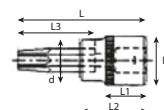

Ref.	Medida (mm)	L1 (mm)	L2 (mm)	L3 (mm)	L (mm)	D (mm)	d (mm)	Preço
S10H230	3	13	21	25	37	12	10,8	1.05€
S10H235	3,5	13	21	25	37	12	10,8	1.05€
S10H240	4	13	21	25	37	12	10,8	1.05€
S10H245	4,5	13	21	25	37	12	10,8	1.05€
S10H250	5	13	21	25	37	12	10,8	1.05€
S10H255	5,5	13	21	25	37	12	10,8	1.05€
S10H260	6	13	21	25	37	12	10,8	1.05€
S10H270	7	13	21	25	37	12	10,8	1.05€



S10H3

Chave de caixa bit fenda 3/8"



Ref.	Medida (mm)	L1 (mm)	L2 (mm)	L3 (mm)	L (mm)	D (mm)	d (mm)	Preço
S10H340	4	15,5	26,5	30	48	18	13,8	1.05€
S10H350	5	15,5	26,5	30	48	18	13,8	1.05€
S10H355	5,5	15,5	26,5	30	48	18	13,8	1.10€
S10H360	6	15,5	26,5	30	48	18	13,8	1.10€
S10H370	7	15,5	26,5	30	48	18	13,8	1.15€
S10H380	8	15,5	26,5	30	48	18	15,8	1.15€
S10H3100	10	15,5	26,5	30	48	20	17,8	1.35€
S10H3120	12	15,5	26,5	30	48	20	17,8	1.55€

S10H4

Chave de caixa bit fenda 1/2"



Ref.	Medida (mm)	L1 (mm)	L2 (mm)	L3 (mm)	L (mm)	D (mm)	d (mm)	Preço
S10H480	8	20	36	30	55	22	17,8	2.15€
S10H490	9	20	36	30	55	22	17,8	2.35€
S10H4100	10	20	36	30	55	22	17,8	2.35€
S10H4110	11	20	36	30	55	24	20,8	2.45€
S10H4120	12	20	36	30	55	24	20,8	2.50€

S11H2



Chave de caixa bit phillips 1/4"



Ref.	Medida	L1 (mm)	L2 (mm)	L3 (mm)	L (mm)	D (mm)	d (mm)	Preço
S11H200	PH0	13	19	25	37	12	10,8	1.05€
S11H201	PH1	13	19	25	37	12	10,8	1.05€
S11H202	PH2	13	19	25	37	12	10,8	1.05€
S11H203	PH3	13	19	25	37	12	10,8	1.05€

S11H3

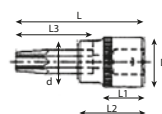
Chave de caixa bit phillips 3/8"



Ref.	Medida	L1 (mm)	L2 (mm)	L3 (mm)	L (mm)	D (mm)	d (mm)	Preço
S11H300	PH0	16,5	26	30	48	18	13,8	1.15€
S11H301	PH1	16,5	26	30	48	18	13,8	1.15€
S11H302	PH2	16,5	26	30	48	18	13,8	1.20€
S11H303	PH3	16,5	26	30	48	18	15,8	1.20€
S11H304	PH4	16,5	26	30	48	18	15,8	1.35€

S11H4

Chave de caixa bit phillips 1/2"



Ref.	Medida	L1 (mm)	L2 (mm)	L3 (mm)	L (mm)	D (mm)	d (mm)	Preço
S11H402	PH2	55	38	30	55	24	15	2.15€
S11H403	PH3	55	38	30	55	24	15	2.15€
S11H404	PH4	55	38	30	55	24	15	2.15€



S49H4



Chave de caixa bits estriado XZN de 1/2"

Ref.	Medida	Comp. (mm)	Preço
S49H4105	M5	55	2.85€
S49H4106	M6	55	2.85€
S49H4108	M8	55	2.90€
S49H4110	M10	55	2.90€
S49H4112	M12	55	3.05€
S49H4114	M14	55	3.45€
S49H4116	M16	55	5.10€
S49H4308	M8	100	4.20€
S49H4310	M10	100	4.30€
S49H4312	M12	100	4.35€
S49H4314	M14	100	5.40€
S49H4318	M18	100	8.00€



S50H3106S



10.80€

Jogo de 6 bits hexagonais 3/8"

Composição:

Chaves: 4; 5; 6; 7; 8 e 10 mm



S50H3206S



11.20€

Jogo de 6 bits hexagonais 3/8" SAE

Composição:

Chaves: 5/32"; 3/16"; 7/32"; 1/4"; 5/16" e 3/8"



S54H5509S



13.20€

Jogo de 9 chaves de torx de 1/4" e 3/8"

Composição:

S54H2 Chaves de 1/4": T10; T15; T20 e T25

S54H3 Chaves de 3/8": T25; T30; T40; T45 e T50



S63H33



Chave de caixa Ribe 3/8"

Ref.	Medida	Comp. (mm)	Preço
S63H3306	M6	90	1.45€
S63H3307	M7	90	1.75€
S63H3308	M8	90	1.95€
S63H3310	M10	90	2.55€

S63H43



Chave de caixa Ribe 1/2"

Ref.	Medida	Comp. (mm)	Preço
S63H4306	M6	100	2.95€
S63H4307	M7	100	3.05€
S63H4308	M8	100	3.15€
S63H4310	M10	100	3.25€
S63H4312	M12	100	3.35€
S63H4313	M13	100	3.45€

S63H44



Chave de caixa Ribe 1/2"

Ref.	Medida	Comp. (mm)	Preço
S63H4405	M5	55	2.45€
S63H4406	M6	55	2.55€
S63H4407	M7	55	2.65€
S63H4408	M8	55	2.75€
S63H4409	M9	55	2.85€
S63H4410	M10	55	2.95€
S63H4412	M12	55	3.25€
S63H4413	M13	55	3.75€
S63H4414	M14	55	4.35€

S63H4507S

19.50€

Jogo de 7 bits longos 6 caneluras (Ribe) 3/8" e 1/2"

Composição:

Bits 3/8" de 90 mm: M6; M7; M8 e M10

Bits 1/2" de 100 mm: M12; M13 e M14



S63H46



Chave de caixa Ribe 1/2"

Ref.	Medida	Comp. (mm)	Preço
S63H4605	M5	100	2.95€
S63H4606	M6	100	3.00€
S63H4607	M7	100	3.05€
S63H4608	M8	100	3.10€
S63H4609	M9	100	3.25€
S63H4610	M10	100	3.30€
S63H4612	M12	100	3.65€
S63H4613	M13	100	4.70€
S63H4614	M14	100	4.90€



S63H47

Chave de caixa Ribe 1/2"



Ref.	Medida	Comp. (mm)	Preço
S63H4708	M8	140	3.50€
S63H4709	M9	140	3.50€
S63H4710	M10	140	3.55€
S63H4712	M12	140	4.20€
S63H4713	M13	140	5.00€
S63H4714	M14	140	5.10€

S63H48

Chave de caixa Ribe 1/2"



Ref.	Medida	Comp. (mm)	Preço
S63H4808	M8	200	4.30€
S63H4809	M9	200	4.40€
S63H4810	M10	200	4.50€
S63H4812	M12	200	5.40€
S63H4813	M13	200	6.45€
S63H4814	M14	200	6.55€

C-DMH

Barra magnética para chaves de caixa



Ref.	Medida	Capacid. (chaves)	Preço
C-DMH212	1/4"	12	14.50€
C-DMH314	3/8"	14	22.30€
C-DMH414	1/2"	12	23.70€

MSH

Régua suporte para chaves de caixa



Ref.	Medida	Capacid. (chaves)	Preço
MSH1214	1/2"	14	2.00€
MSH1414	1/4"	14	1.70€
MSH3814	3/8"	14	1.90€

S15H

Cardan

Ref.	Medida	D1 (mm)	D2 (mm)	L (mm)	Acabamento	Preço
S15H240	1/4"	14	14	35	Mate	2.35€
S15H356	3/8"	18	18	49	Mate	3.65€
S15H472	1/2"	25	25	69	Mate	4.60€
S15H6109	3/4"	39,7	39,5	106,2	Polido	22.45€

S64H4

Chave de caixa bits estriado XZN de 1/2"



Ref.	Medida	Comp. (mm)	Preço
S64H4104	M4	55	2.30€
S64H4105	M5	55	2.30€
S64H4106	M6	55	2.30€
S64H4107	M7	55	2.30€
S64H4109	M9	55	2.30€
S64H4113	M13	55	3.10€
S64H4204	M4	100	2.90€
S64H4205	M5	100	2.90€
S64H4206	M6	100	2.90€
S64H4207	M7	100	2.90€
S64H4208	M8	100	2.90€
S64H4209	M9	100	2.90€
S64H4210	M10	100	2.90€
S64H4212	M12	100	3.80€
S64H4214	M14	100	4.70€
S64H4216	M16	100	5.20€
S64H4218	M18	100	8.80€
S64H4705	M5	140	3.40€
S64H4706	M6	140	3.40€
S64H4708	M8	140	3.40€
S64H4709	M9	140	3.45€
S64H4710	M10	140	3.50€
S64H4712	M12	140	4.20€
S64H4714	M14	140	5.00€
S64H4808	M8	200	4.20€
S64H4810	M10	200	4.20€
S64H4812	M12	200	5.30€
S64H4814	M14	200	6.20€



S16H

Adaptador

Ref.	Medida	A (mm)	D1 (mm)	D2 (mm)	L (mm)	Acabamento	Preço
S16H1234	1/2" F - 3/4" M	19	12,7	27	45	Polido	3.35€
S16H1238	1/2" F - 3/8" M	9,52	12,7	22	34	Mate	1.25€
S16H1438	1/4" F - 3/8" M	9,52	6,35	14	25	Mate	1.05€
S16H3410	3/4" F - 1" M	25,3	19,05	39,7	59,6	Polido	9.70€
S16H3412	3/4" F - 1/2" M	12,7	19,05	35	51	Polido	5.40€
S16H3812	3/8" F - 1/2" M	12,7	9,52	17	35	Mate	1.25€
S16H3814	3/8" F - 1/4" M	6,35	9,75	18,6	28	Mate	1.05€



S16H

Adaptador

Ref.	Medida	A (mm)	D1 (mm)	D2 (mm)	L (mm)	Acabamento	Preço
S16H302	1/4" M - 3/8" F	6,35	9,75	18,6	28	Mate	2.05€
S16H304	1/2" M - 3/8" F	12,7	9,75	23,5	43,7	Mate	3.05€
S16H403	3/8" M - 1/2" F	9,5	12,9	23,5	40	Mate	3.05€



S17H

Chave de velas

Ref.	Medida	A (mm)	D1 (mm)	D2 (mm)	L (mm)	Acabamento	Preço
S17H3116	3/8"	9,525	21,7	18,8	65	Mate	1.55€
S17H3121	3/8"	9,525	27,6	21,5	65	Mate	2.05€
S17H4116	1/2"	12,7	21,8	21,8	65	Mate	1.55€
S17H4121	1/2"	12,7	27,6	23,6	65	Mate	2.15€

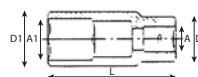

S17H3414

5.00€

Chave de velas 12 faces 3/8"

Medida: 14mm
Acabamento: Mate



S21H

Extensão

Ref.	Quadra	Medida (mm)	Acabamento	Preço
S21H4150	1/2"	50	Mate	3.05€
S21H4175	1/2"	75	Mate	3.25€
S21H41125	1/2"	125	Mate	4.30€
S21H41250	1/2"	250	Mate	6.35€



S22H

Cabo articulado

Ref.	Quadra	Medida (mm)	Acabamento	Preço
S22H21130	1/4"	130	Mate	5.00€
S22H31200	3/8"	200	Mate	6.75€
S22H41375	1/2"	375	Mate	13.25€
S22H41450	1/2"	450	Mate	18.00€



S22H

Cabo articulado

Ref.	Quadra	Medida (mm)	Acabamento	Preço
S22H41600	1/2"	600	Polido	22.00€
S22H6500	3/4"	500	Polido	30.00€



S22H41600RK

8.50€

Kit de reparação para cabo articulado S22H41600



S22H6500RK

11.60€

Kit de reparação para cabo articulado S22H6500



S22H21130RK

2.30€

Kit de reparação para cabo articulado S22H21130



S22H41375RK

2.95€

Kit de reparação para cabo articulado S22H41375



S22H41450RK

3.25€

Kit de reparação para cabo articulado S22H41450



S23H



Cabo "T" correção

Ref.	Quadra	Medida (mm)	Acabamento	Preço
S23H21115	1/4"	115	Mate	2.50€
S23H31200	3/8"	200	Mate	4.30€
S23H41250	1/2"	250	Mate	5.40€
S23H41300	1/2"	300	Mate	6.15€
S23H6450	3/4"	450	Polido	17.15€
S23H6500	3/4"	500	Polido	18.50€
S23H8550	1"	550	Polido	37.50€

S24H



Extensões

Ref.	Quadra	Medida (mm)	Acabamento	Preço
S24H250	1/4"	50	Mate	1.10€
S24H375	3/8"	75	Mate	1.60€
S24H450	1/2"	50	Mate	2.30€
S24H475	1/2"	75	Mate	2.70€
S24H2100	1/4"	100	Mate	1.20€
S24H2150	1/4"	150	Mate	1.40€
S24H3150	3/8"	150	Mate	2.30€
S24H3200	3/8"	200	Mate	2.65€
S24H3250	3/8"	250	Mate	3.20€
S24H4125	1/2"	125	Mate	3.30€
S24H4224	1/2"	610	Polido	20.00€
S24H4250	1/2"	250	Mate	4.10€
S24H6100	3/4"	100	Polido	8.15€
S24H6200	3/4"	200	Polido	11.00€
S24H6400	3/4"	400	Polido	19.40€
S24H8200	1"	200	Polido	24.00€

S26H2150

2.50€

Punho de 1/4"



S26H2280

11.60€

Punho 1/4" dupla função fixo/ cardan



S27H



Extensões flexíveis

Ref.	Quadra	Medida (mm)	Preço
S27H2	1/4"	145	2.15€
S27H3	3/8"	193	16.60€
S27H4	1/4"	205	16.50€

Ferramenta de aperto

S40T

Chave em T com ponta flexível



Ref.	Medida (mm)	Preço
S40T108	8	20.00€
S40T110	10	20.00€
S40T112	12	20.00€
S40T113	13	20.00€
S40T114	14	20.00€
S40T117	17	20.00€
S40T119	19	20.00€

S40T109S

138.00€

Jogo de 9 peças "T" flexíveis

Composição/ medidas em mm:
8; 10; 12; 13; 14; 17 e 19
Travessões P/T



S41H41

10.40€

Manivela quadra macho de 1/2"



S42M

Extensões magnéticas



Ref.	Quadra	Medida (mm)	Preço
S42M475	1/2"	75	8.30€
S42M4125	1/2"	125	8.50€
S42M4250	1/2"	250	11.50€

S42M403S

27.00€

Jogo de 3 extensões magnéticas 1/2"

Composição/ medidas em mm:
75; 125 e 250



S43H210

19.70€

Extensão articulada em "T" com 1/2"; 3/8" e 1/4"
Acabamento: Polido



S44H2206

0.90€

Porta bits 1/4"

Quadra de 1/4" para uso em bits com encaixamento de 1/4"



S44H3110A

2.30€

Porta bits

Quadra: 3/8"

Utilização em bits: 3/8"



S44H4110

1.80€

Porta bits

Quadra: 1/2"

Utilização em bits: 3/8"



S60H4304S

36.50€

Jogo de 4 extensões de 1/2"

Composição/ medidas em mm:
75; 125; 250 e 375



R53A-3

Adaptador "macho/macho"

Para aplicação em conjunto com o cabo "T" flexível R53A

Ref.	Quadra	Compr. (mm)	Preço
R53A-3A	3/8"	30	1.40€
R53A-4A	1/2"	35	1.90€



R19H3

Chave pata de galo 3/8"

Ref.	Medida (mm)	Preço
R19H3110	10	4.20€
R19H3111	11	4.20€
R19H3112	12	4.20€
R19H3113	13	4.20€
R19H3114	14	4.20€
R19H3115	15	4.20€
R19H3116	16	4.40€
R19H3117	17	4.50€
R19H3118	18	4.60€
R19H3119	19	4.60€



R19H310S

41.50€

Jogo de 10 chaves pata de galo de 3/8"

Composição/ medidas em mm:

Chaves: 10; 11; 12; 13; 14; 15; 16; 17; 18 e 19



S03A4111S

34.50€

Jogo de 11 chaves de impacto de 1/2"

Composição/ medidas (mm):

S03A4 Chaves: 10; 11; 12; 13; 14; 16; 17; 19; 21; 22 e 24



S01U41

Cardan de impacto 1/2"

Ref.	Medida (mm)	Compr. (mm)	Preço
S01U4113	13	70	10.50€
S01U4114	14	70	10.60€
S01U4115	15	70	10.70€
S01U4116	16	70	10.80€
S01U4117	17	70	11.20€
S01U4119	19	70	11.50€
S01U4121	21	70	11.90€
S01U4122	22	70	12.40€



S01U4108S

87.00€

Jogo 8 chaves/ cardans impacto 1/2"

 Composição/ medidas em mm:
 Chaves: 13; 14; 15; 16;
 17; 19; 21 e 22

S03A2
Chave de impacto 1/4"

Ref.	Quadra	Medida (mm)	Preço
S03A2110	1/4"	10	1.45€
S03A2112	1/4"	12	1.55€
S03A2114	1/4"	14	1.65€

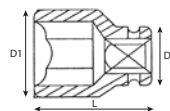
S03A4
Chave impacto 1/2"

Ref.	Medida (mm)	D1 (mm)	D2 (mm)	L (mm)	Preço
S03A4109	9	15	24	38	2.65€
S03A4110	10	17	24	38	2.65€
S03A4111	11	19	24	38	2.65€
S03A4112	12	20	24	38	2.70€
S03A4113	13	20,8	24	38	2.70€
S03A4114	14	22	24	38	2.75€
S03A4115	15	24	24	38	2.75€
S03A4116	16	24	24	38	2.95€
S03A4117	17	26	26	38	3.15€
S03A4118	18	26	27	38	3.25€
S03A4119	19	28	28	38	3.35€
S03A4121	21	30	30	38	3.45€
S03A4122	22	32	30	38	3.75€
S03A4123	23	34	30	38	4.10€
S03A4124	24	34	30	43	4.20€
S03A4127	27	38	30	43	6.10€
S03A4129	29	40	30	48	6.65€
S03A4130	30	42	30	48	6.70€
S03A4132	32	44,6	30	48	7.15€

S03AD4
Chave impacto longa 1/2"

Ref.	Medida (mm)	D1 (mm)	D2 (mm)	L (mm)	Preço
S03AD4110	10	17	24	78	4.40€
S03AD4111	11	19	24	78	4.45€
S03AD4112	12	19,6	24	78	4.50€
S03AD4113	13	20,8	24	78	4.55€
S03AD4114	14	22	24	78	4.60€
S03AD4115	15	24	24	78	4.60€
S03AD4116	16	24	24	78	4.65€
S03AD4117	17	26	26	78	4.80€
S03AD4118	18	28	27	78	5.00€
S03AD4119	19	28	28	78	5.10€
S03AD4121	21	30	30	78	5.60€
S03AD4122	22	32	30	78	5.90€
S03AD4124	24	34,6	30	78	6.70€
S03AD4126	26	37	30	78	7.90€
S03AD4127	27	38	30	78	8.40€
S03AD4128	28	39,5	30	78	8.60€
S03AD4130	30	42	30	78	10.00€
S03AD4132	32	44,6	30	78	10.70€

Ferramenta de aperto

S03AD4111S

53.80€

Jogo de 11 chaves de impacto longas de 1/2"

Composição/ medidas (mm):

S03AD4 Chaves: 10; 11; 12; 13; 14; 16; 17; 19; 21; 22 e 24



S03A4A

Adaptador de 1/2"

Ref. Quadra Preço

S03A4A3 3/8" 4.10€

S03A4A6 3/4" 5.60€



S03A4U4

Cardan de 1/2"

10.00€



S03A4UT3S

27.90€

Jogo de 3 cardans impacto

Composição/ medidas:

1/4"; 3/8" e 1/2"



S03A4E

Extensão



Ref.	Quadra	Medida (mm)	Preço
S03A4E4	1/2"	100	5.00€
S03A4E5	1/2"	125	4.80€
S03A4E6	1/2"	150	6.10€
S03A4E8	1/2"	200	7.20€

S03A4211S

35.70€

Jogo de 11 chaves impacto 1/2" SAE

Composição:

Ref.	Medida	Ref.	Medida
S03A4210	3/8"	S03AD4219	3/4"
S03A4211	7/16"	S03AD4221	13/16"
S03A4213	1/2"	S03AD4222	7/8"
S03A4214	9/16"	S03AD4224	15/16"
S03A4216	5/8"	S03AD4226	1"
S03A4217	11/16"		



S03AD4414S

82.00€

Jogo de 14 chaves longas impacto 1/2" SAE

Composição/ medidas:

Chaves: 3/8"; 7/16"; 1/2"; 9/16"; 5/8"; 11/16"; 3/4"; 13/16"; 7/8"; 15/16"; 1"; 1-1/16"; 1-1/8" e 1-1/4"



S03A6

Chave impacto 3/4"

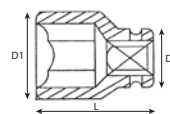

Ref.	Medida (mm)	D1 (mm)	D2 (mm)	L (mm)	Preço
S03A6126	26	41	38	51	6.80€
S03A6127	27	43	40	53	6.90€
S03A6129	29	45	42	53	7.50€
S03A6130	30	46	44	53	7.90€
S03A6132	32	49	44	57	8.50€
S03A6133	33	51	44	57	9.15€
S03A6134	34	51	44	57	9.40€
S03A6135	35	53	44	57	10.10€
S03A6136	36	54	44	57	10.40€
S03A6137	37	55	44	57	10.70€
S03A6138	38	56	44	57	11.00€
S03A6139	39	57,7	44	57	12.15€
S03A6140	40	59	44	57	13.15€
S03A6141	41	60	44	57	13.20€
S03A6142	42	61,4	44	57	15.80€
S03A6143	43	62,7	44	62	16.50€
S03A6144	44	64	44	62	17.80€
S03A6145	45	65	44	62	18.40€
S03A6146	46	66,4	44	62	18.60€
S03A6147	47	67,6	44	67	19.20€
S03A6148	48	68,8	44	67	19.80€
S03A6149	49	70	44	72	20.60€
S03A6150	50	71,4	72	72	22.60€
S03A6151	51	72,8	72	72	25.50€
S03A6152	52	74	72	72	26.40€
S03A6153	53	75	72	72	27.50€
S03A6154	54	76,4	72	72	28.00€
S03A6155	55	77,7	74	74	29.00€
S03A6156	56	79	74	74	31.10€
S03A6157	57	80	74	74	33.00€
S03A6158	58	81,5	75	75	33.10€
S03A6159	59	82,7	75	75	37.20€
S03A6160	60	84	75	75	39.80€
S03A6163	63	87,6	75	75	41.80€
S03A6165	65	90	78	78	44.30€
S03A6167	67	92,7	80	80	48.90€
S03A6170	70	96,4	83	83	56.00€

S03A6108S

67.50€

Jogo de 8 chaves de impacto de 3/4"

Composição/ medidas:

S03A6 Chaves: 26; 27; 29; 30; 32; 35; 36 e 38



S03AD6

Chave impacto longa 3/4"

Ref.	Medida (mm)	D1 (mm)	D2 (mm)	L (mm)	Preço
S03AD6126	26	41,3	44	90	15.00€
S03AD6127	27	42,6	44	90	15.05€
S03AD6129	29	45,1	44	90	15.30€
S03AD6130	30	46,4	44	90	15.35€
S03AD6132	32	48,9	44	90	15.70€
S03AD6133	33	50,6	44	90	15.75€
S03AD6134	34	51,4	44	90	16.50€
S03AD6135	35	52,7	44	90	16.80€
S03AD6136	36	53,9	44	90	17.60€
S03AD6138	38	56,4	44	90	18.90€
S03AD6140	40	58,9	44	90	22.50€
S03AD6141	41	60,1	44	90	23.60€
S03AD6142	42	61,4	44	90	25.40€
S03AD6144	44				27.50€
S03AD6146	46	66,4	44	90	30.40€
S03AD6150	50	71,4	54	90	34.00€



S03AD6107S

109.00€

Jogo de 7 chaves de impacto longas de 3/4"

Composição/ medidas:

S03AD6 Chaves: 26; 27; 29;
32; 35; 36 e 38



S03AD6120S

248.00€

Jogo de 20 peças de impacto de 3/4"

Composição/ medidas em mm:

S03AD6 Chaves: 24; 27; 30; 32; 33; 34; 35; 36; 41 e 46
 S03A6A4 Adaptador 3/4" - 1/2"
 S03A6A8 Adaptador 3/4" - 1"
 S03A6U6 Cardan 3/4
 S03A6E Extensão de 3/4" 250 mm
 Pinos
 O'ring



S03A6A

Adaptador de 3/4"

Ref.	Quadra	Preço
S03A6A4	1/2"	10.20€
S03A6A8	1"	12.20€



S03A6U6

34.60€

Cardan de 3/4"



S03A6E

Extensão

Ref.	Quadra	Medida (mm)	Preço
S03A6E04	3/4"	100	17.30€
S03A6E08	3/4"	200	22.40€
S03A6E10	3/4"	250	24.40€

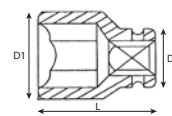

S03A8
Chave impacto 1"

Ref.	Medida (mm)	D1 (mm)	D2 (mm)	L (mm)	Preço
S03A8124	24	41,9	54	58	16.30€
S03A8127	27	45,6	54	58	16.35€
S03A8129	29	48,1	54	60	16.50€
S03A8130	30	49,4	54	60	16.55€
S03A8132	32	51,9	54	60	16.60€
S03A8133	33	53,6	54	60	16.80€
S03A8134	34	54,4	54	62	17.30€
S03A8135	35	55,7	54	62	17.80€
S03A8136	36	56,9	54	62	17.85€
S03A8138	38	59,4	54	65	18.30€
S03A8140	40	110	15		19.10€
S03A8141	41	63,1	54	65	19.40€
S03A8144	44	120	15		23.40€
S03A8146	46	69,4	54	74	24.50€
S03A8150	50	74,4	54	74	30.10€
S03A8155	55	80,7	54	85	36.70€
S03A8160	60	87,1	54	90	47.50€
S03A8165	65	93,2	54	90	56.00€
S03A8170	70	99,4	54	100	71.00€
S03A8173	73	103,3	86	100	83.00€
S03A8175	75	105,6	86	100	93.00€
S03A8176	76	106,9	86	100	104.00€
S03A8178	78	110	86	100	109.00€
S03A8180	80	111,9	86	100	115.50€
S03A8185	85	118,5	86	110	139.50€
S03A8189	89	123,2	86	110	142.50€
S03A8190	90	124,4	86	110	160.00€
S03A8192	92	126,8	86	110	167.00€
S03A8195	95	129	86	110	185.00€

S03A8109S
170.00€
Jogo de 9 chaves impacto 1"

Composição/ medidas:

S03A8 Chaves: 24; 27; 30; 32; 35; 38; 41; 46 e 50

S03A8A6
17.00€
Adaptador 1" - 3/4"

S03A8E
Extensão impacto

Ref.	Quadra	Medida (mm)	Preço
S03A8E04	1"	100	25.50€
S03A8E07	1"	175	31.50€
S03A8E10	1"	250	47.80€

S03AD8107S
165.00€
Jogo de 7 chaves longas de impacto 1"

Composição/ medidas:

S03AD8 Chaves: H5, H6, H8, H10, H12, H14, H17 e H19
Mala metálica

S03AD8

Chave impacto longa 1"

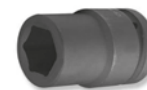

Ref.	Medida (mm)	D1 (mm)	D2 (mm)	L (mm)	Preço
S03AD8117	17	33,1	54	90	21.30€
S03AD8124	24	41,9	54	90	21.80€
S03AD8126	26	43,3	54	90	21.90€
S03AD8127	27	45,6	54	90	22.00€
S03AD8129	29	48,1	54	90	22.10€
S03AD8130	30	49,4	54	90	22.30€
S03AD8132	32	51,9	54	90	22.60€
S03AD8133	33	53,6	54	90	22.80€
S03AD8134	34	54,4	54	90	23.00€
S03AD8135	35	55,7	54	90	23.50€
S03AD8136	36	56,9	54	90	24.00€
S03AD8138	38	59,4	54	90	26.00€
S03AD8140	40	61,9	54	90	27.50€
S03AD8141	41	63,1	54	90	28.20€
S03AD8142	42	64,4	54	90	29.10€
S03AD8146	46	69,4	54	90	35.00€
S03AD8148	48	71,8	54	90	37.50€
S03AD8150	50	74,4	54	90	43.00€
S03AD8155	55	80,7	54	90	53.50€
S03AD8158	58	84,5	54	105	58.50€
S03AD8160	60	87,1	54	120	67.50€
S03AD8165	65	93,2	54	120	75.00€

S03S8

Chave de impacto quadrada



Ref.	Quadra	Medida (mm)	Preço
S03S8117	1"	17	15.00€
S03S8119	1"	19	16.00€
S03S8121	1"	21	16.50€

S03SD8

Chave de impacto longa quadrada



Ref.	Quadra	Medida (mm)	Preço
S03SD8117	1"	17	20.50€
S03SD8119	1"	19	21.00€
S03SD8121	1"	21	21.50€

S05A4H

Bit hexagonal de impacto 1/2"

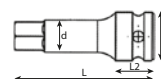

Ref.	Medida	D (mm)	d (mm)	L2 (mm)	L (mm)	Preço
S05A4H4	H4	25	6	22,5	78	7.90€
S05A4H5	H5	25	7	22,5	78	8.00€
S05A4H6	H6	25	8	22,5	78	8.10€
S05A4H8	H8	25	10,5	22,5	78	8.15€
S05A4H10	H10	25	12,5	22,5	78	8.60€
S05A4H12	H12	25	15	22,5	78	8.60€
S05A4H14	H14	25	17,5	22,5	78	8.60€
S05A4H17	H17	25	21	22,5	78	8.60€
S05A4H18	H18	25	22	22,5	78	8.60€
S05A4H19	H19	25	23	22,5	78	8.65€

S05A408S

57.00€

Jogo de 8 chaves de caixa com ponta macho hexagonal de impacto 1/2"

Composição:

S05A4 Chaves: H5; H6; H8; h10; H12; H14; H17 e H19

S05A6105S

90.50€

Jogo de 5 bits hexagonais de impacto 3/4"

Composição:

S05A6 Chaves: 14; 17; 19; 22 e 24mm de 88mm

S06A4T

Chaves de caixa com ponta macho torx de impacto de 1/2"

Ref.	Medida	Preço
S06A4T20	T20	8.15€
S06A4T27	T27	8.15€
S06A4T30	T30	8.15€
S06A4T40	T40	8.20€
S06A4T45	T45	8.20€
S06A4T50	T50	8.20€
S06A4T55	T55	8.25€
S06A4T60	T60	8.25€
S06A4T70	T70	8.30€
S06A4T80	T80	8.30€

S06A408S

50.00€

Jogo de 8 chaves de caixa com ponta macho torx de impacto 1/2"

Composição:

S06A4 Chaves: T30; T40; T45; T50; T55; T60; T70 e T80

S64A4106S

38.00€

Jogo de 6 chaves de impacto XZN de 1/2"

Composição:

S064A4 3 Chaves: M14; M16 e M18 de 45mm
3 Chaves: M14; M16 e M18 de 76mm

S64A6306S

70.00€

Jogo de 6 chaves de impacto XZN e Torx de 3/4"

Composição:

S064A6 4 Chaves Torx: T70; T80; T90 e T100 de 61mm
2 Chaves XZN: M16 e M18 de 61mm

S12A4525S

185.00€

Jogo de 25 chaves impacto magnéticas de 1/2"

Composição:

 Chaves de 1/2": 3/8"; 7/16"; 1/2"; 9/16"; 5/8"; 11/16";
3/4"; 13/16"; 7/8"; 15/16" e 1"
Chaves de 1/2": 10 a 21mm
Cardan de 1/2"
Extensão 80mm

S18A4117M

16.00€

Chave impacto magnética de 17 mm de 1/2"

S18A4119M

15.50€

Chave impacto magnética de 19 mm de 1/2"

S18A4121M

15.80€

Chave impacto magnética de 21 mm de 1/2"

S18A4103MS

52.50€

Jogo de 3 chaves impacto magnéticas de 1/2"

Composição:

Chaves: 17; 19 e 21mm



S18A41

Chave de impacto longa para rodas



Ref.	Quadra	Medida (mm)	D (mm)	L (mm)	Cor	Preço
S18A4115	1/2"	15	25	85	Laranja	6.15€
S18A4117	1/2"	17	27	85	Azul	7.45€
S18A4119	1/2"	19	28,5	85	Verde	7.65€
S18A4121	1/2"	21	31	85	Vermelho	7.85€

S18AD41

Chave de impacto extra longa para rodas



Ref.	Quadra	Medida (mm)	D (mm)	L (mm)	Cor	Preço
S18AD4117	1/2"	17	27	150	Azul	16.35€
S18AD4119	1/2"	19	28,5	150	Verde	16.65€
S18AD4121	1/2"	21	31	150	Vermelho	16.85€



S03AD4317

Chave impacto de 17 mm de 1/2"

7.30€



S03AD4319

Chave impacto de 19 mm de 1/2"

7.30€



S03AD4321

Chave impacto de 21 mm de 1/2"

7.40€



S03AD4303S

Jogo de 3 chaves impacto de 1/2"

23.50€

Composição:

Ref.	Medida (mm)
S03AD4317	17
S03AD4319	19
S03AD4321	21



S03AD4503S

Jogo de 3 chaves impacto longas de 1/2"

57.00€

Composição:

Ref.	Medida (mm)	Compr. (mm)
S03AD4517	17	150
S03AD4519	19	150
S03AD4521	21	150



S03AD4307S

Jogo de 7 chaves impacto de 1/2"

68.00€

Composição:

Ref.	Medida (mm)	Ref.	Medida (mm)
S03AD4317	17	S03AD4323	23
S03AD4319	19	S03AD4324	24
S03AD4321	21	S03AD4327	27
S03AD4322	22		



S03AD4517

Chave impacto longa de 17 mm de 1/2"

16.50€



S03AD4519

Chave impacto longa de 19 mm de 1/2"

16.70€



S03AD4521

Chave impacto longa de 21 mm de 1/2"

17.10€



S46TE80

Barra de torque 110Nm de 1/2"

14.00€

Comprimento: 196mm

Cor: azul



P018 14.70€

Alicate universal
Comprimento: 200mm



P038 11.00€

Alicate de corte diagonal
Comprimento: 200mm



P046 9.70€

Alicate de corte
Comprimento: 160mm



P068 11.70€

Alicate de pontas
Comprimento: 200mm
Capacidade máxima: Ø3,0mm



P068A 10.30€

Alicate de pontas
Comprimento: 200mm



P079 17.00€

Alicate universal
Comprimento: 220mm
Capacidade máxima: Ø3,0mm



P6008 7.90€

Alicate regulável (2 posições)
Comprimento: 200mm



P61

Alicate de corte frontal

Ref.	Compr. (mm)	Preço
P6106	160	9.50€
P6108	200	11.30€



P9506 13.70€

Alicate corta fios
Comprimento: 165mm
Peso: 188g



P27

Alicate ajustável

Ref.	Compr. (mm)	Preço
P2706	160	10.00€
P2710	250	13.20€
P2712	330	20.80€



Alicates

com revestimento antideslizante

P2810 13.70€

Alicate ajustável
Comprimento: 250mm



P266 9.50€

Alicate de freios internos e externos (pontas intermutáveis)
Capacidade: freios de 12 a 50mm
Pontas de: Ø1,2 e 1,5mm
Pontas direitas de: 45 e de 90°



AG01000

Alicate de freios interiores (pontas direitas)

Ref.	Compr. (mm)	Preço
AG010002	175	9.30€
AG010003	230	14.00€



AG01000

Alicate de freios interiores (pontas curvas)

Ref.	Compr. (mm)	Preço
AG010005	175	9.50€
AG010006	230	13.90€



AG01000

Alicate de freios exteriores (pontas direitas)

Ref.	Compr. (mm)	Preço
AG010008	175	9.50€
AG010009	230	13.30€



AG01000

Alicate de freios exteriores (pontas curvas 90°)

Ref.	Compr. (mm)	Preço
AG010011	175	9.70€
AG010012	230	13.70€



Alicates

com mola

P9508C

16.90€

Alicate de freios interiores (pontas curvas)

Comprimento: 216mm
Capacidade: 10-32mm



P9508D

16.90€

Alicate de freios exteriores (pontas curvas)

Comprimento: 216mm
Capacidade: 10-32mm



P9902S

225.00€

Jogo de 2 alicate de freios

Composição:
P9920A Alicate de freios internos
P9920C Alicate de freios externos
Capacidade: 165-300mm



com mola

P7101

16.50€

Mini alicate de pontas curvas 45° (desenho ergonómico)

Comprimento: 140mm
Peso: 90g



P7102

15.50€

Mini alicate de corte frontal (desenho ergonómico)

Comprimento: 110mm
Peso: 90g



P7103

14.30€

Mini alicate de corte diagonal (desenho ergonómico)

Comprimento: 115mm
Peso: 90g



P7104

14.30€

Mini alicate universal (desenho ergonómico)

Comprimento: 120mm
Peso: 90g



P7105

13.80€

Mini alicate de pontas direitas (desenho ergonómico)

Comprimento: 135mm
Peso: 90g



P8006

16.70€

Alicate universal

Comprimento: 160mm



P8106

16.80€

Alicate pontas longas

Comprimento: 160mm



P8606

17.00€

Alicate de corte diagonal

Comprimento: 160mm



P9006

16.40€

Alicate pontas chatas

Comprimento: 160mm







Símbolo				
Tipo de material	Macio	Dureza média	Duro	Corda de piano
Exemplo	Cobre, alumínio	Ferro	Aço	Aço duro/ mola
Tensão N/mm ²	220-250	750-800	1700-1800	2200-2300



P051
Alicate corta cabos

Ref.	Compr. (mm)	mm ²	Ø mm	Preço
P0516	160	22	9.5	14.50€
P0518	200	38	11.5	16.50€





P081
Alicate universal

Ref.	Compr. (mm)					Preço
P0816	160	4.0	2.8	1.8	1.4	11.20€
P0817	180	4.0	3.0	2.0	1.6	12.50€
P0818	200	4.0	3.0	2.0	1.6	15.00€



P091
Alicate de corte (trabalho intensivo)

Ref.	Compr. (mm)					Preço
P0916	160	4.0	3.0	2.0	1.6	13.20€
P0917	180	5.0	3.5	2.4	2.0	14.50€
P0918	200	5.0	3.5	2.4	2.0	15.00€





P101
Alicate de corte

Ref.	Compr. (mm)					Preço
P1016	160	4.0	3.0	2.0	1.6	12.00€
P1017	180	4.0	3.0	2.0	1.6	13.30€

P111
Alicate de pontas

Ref.	Compr. (mm)					Preço
P1116	160	4.0	2.8	1.8	1.4	11.00€
P1118	200	4.0	3.0	2.0	1.6	13.60€

P121
Alicate de pontas curvas

Ref.	Compr. (mm)					Preço
P1216	160	4.0	2.8	1.8	1.4	11.60€
P1218	200	4.0	3.0	2.0	1.6	14.00€

P1416
Alicate de pontas chatas

Comprimento: 160mm

11.50€

P1516
Alicate de descarnar

Comprimento: 160mm

12.20€

P4016
Alicate de pontas redondas

Comprimento: 160mm

11.60€

P6116
Alicate de corte frontal

Ref.	Compr. (mm)					Preço
P6116	160	4.0	3.0	2.0	1.6	12.20€

P2811
Alicate ajustável

Ref.	Compr. (mm)	Preço
P28110	240	17.30€
P28112	300	25.00€

P2821
Alicate ajustável

Ref.	Compr. (mm)	Preço
P28210	240	22.00€
P28212	300	29.80€



Alicates

P178

13.70€

Turquês de carpinteiro

Comprimento: 200mm



P1810

13.60€

Turquês de cofragens

Comprimento: 250mm



P2010LA

11.40€

Tesoura articulada

Corte esquerda

Comprimento: 250mm

Peso: 395g

Capacidade de corte: Aço: 1,2mm | Aço inox: 0,7mm



P2010RA

11.30€

Tesoura articulada

Corte direita

Comprimento: 250mm

Peso: 395g

Capacidade de corte: Aço: 1,2mm | Aço inox: 0,7mm



P2010SA

11.40€

Tesoura articulada

Lâminas direitas

Comprimento: 200mm



P22

Tesoura de cortar chapa

Ref.

Compr.
(mm)

Preço

P2208A

205

11.30€

P2212A

305

17.80€



P2205E

10.70€

Tesoura de electricista



P15808

13.50€

Tesoura multifunções

Lâminas em aço inox de 3mm

Comprimento: 206mm



P43

Alicate corta cabos

Ref.

Compr.
(mm)

Peso

Capac.
de corte

Preço

P4318

450

1 570g

Fio 5mm
Cabo 10mm

39.00€

P4330

750

4 200g

Fio 9mm
Cabo 14mm

69.00€



P4318-RK

17.80€

Kit de reparação

P4330-RK

36.80€

Kit de reparação

P6424

37.50€

Alicate corta cabos

Comprimento: 600mm

Peso: 2 700g

Capacidade de corte: Ø 10mm



P7601

18.30€

Alicate longo de pontas direitas

Comprimento: 275mm



P7602

18.50€

Alicate longo de pontas curvas 45°

Comprimento: 275mm



P7603

18.50€

Alicate longo de pontas curvas 90°

Comprimento: 275mm



P7608

19.50€

Alicate longo de pontas redondas Ø13mm

Comprimento: 275mm



P7719

32.30€

Alicate longo de torcer arame

Comprimento: 270mm

Peso: 360g

Capacidade: Ø 0,55mm



V1001 15.00€

Alicate de rebitar (trabalho intensivo)

Inclui 4 bicos: 2,4; 3,2; 4 e 4,8mm



V1002 50.00€

Alicate de rebitar extensível

Inclui 4 bicos: 2,4; 3,2; 4 e 4,8mm



V1002-RK 1.50€

Kit de reparação para alicate de rebitar extensível V1002



V1003 36.50€

Alicate de rebitar (trabalho intensivo)

Inclui bicos: 6,4; 3,2; 4 e 4,8mm



V1005 18.80€

Alicate de rebitar (bicos intermutáveis)

Inclui bicos: 2,4; 3,2; 4 e 4,8mm



V21

Alicate de rebitar (bicos intermutáveis)

Ref.	Bicos (mm)	Preço
V2101	2,4; 3,2; 4 e 4,8 mm	27.50€
V2102	3,2; 4; 4,8 e 6,4 mm	40.50€



V1103 33.50€

Alicate de rebitar fêmeas

Capacidade: M3; M4; M5 e M6



V2401 58.50€

Alicate de rebitar fêmeas

Capacidade: M5; M6; M8 e M10



AR030058 105.00€

Alicate de cravar terminais

Intermutável para 6 tipos de terminais



V1310

Alicate de cravar terminais



Ref.	Caraterísticas	Preço
V1311A	Terminais isolados	38.00€
V1310C	Fichas cabo coaxial	37.00€
V1310E	Terminais não isolados	37.00€
V1310F	Fichas RJ45	41.50€

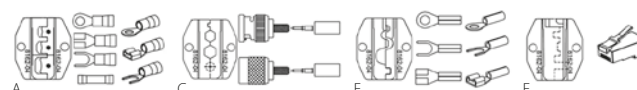

V1310

Acessórios para alicate de cravar V1310

Ref.	Terminais	Preço
V1310A-11	Mordentes	13.00€
V1310B-11	Mordentes	13.00€
V1310E-11	Mordentes	13.00€
V1310F-11	Mordentes RJ45	18.00€
V1310G-11	Mordentes AWG 22-10 (0,5-10mm ²)	18.00€
V1310J-11	Mordentes AWG 10-60 (6-16mm ²)	18.00€

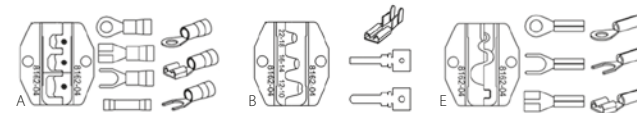

V1401 8.80€

Alicate de cravar terminais/ descarnar fios



V1403 14.50€

Alicate de cravar (trabalho intensivo)



V1501 20.90€

Alicate de descarnar (trabalho intensivo)

Parafuso de ajuste à espessura do fio

Comprimento: 172mm

Peso: 305g



V1505 16.30€

Alicate de descarnar



Alicates

P30M10A

11.80€

Alicate de pressão bicos direitos

Comprimento: 250mm

Peso: 540g



P32M

Alicate de pressão bocas côncavas

Ref.	Compr. (mm)	Preço
------	-------------	-------

P32M07A	180	9.80€
---------	-----	-------

P32M10A	250	11.00€
---------	-----	--------



P36M09A

10.30€

Alicate de pressão bicos longos

Comprimento: 230mm



P37M

Alicate de pressão pescoço de cisne

Ref.	Compr. (mm)	Preço
------	-------------	-------

P37M11A	280	17.10€
---------	-----	--------

P37M18A	450	30.20€
---------	-----	--------



P38M

Alicate de pressão para soldadura

Ref.	Compr. (mm)	Preço
------	-------------	-------

P38M09A	230	15.00€
---------	-----	--------

P38M11A	280	17.80€
---------	-----	--------



P52A10

37.00€

Alicate de pressão boca direita ajustável

Comprimento: 250mm



P52B10

33.00€

Alicate de pressão boca curva ajustável

Comprimento: 250mm



P52C10

42.00€

Alicate de pressão boca curva ajustável

Comprimento: 250mm



P52D12

39.00€

Alicate de pressão boca longa ajustável

Comprimento: 300mm



P52M10

15.00€

Alicate de pressão bocas recurvadas

Comprimento: 250mm



P53M

Alicate pescoço cisne maxilas oscilantes

Ref.	Compr. (mm)	Preço
------	-------------	-------

P53M06	152	11.50€
--------	-----	--------

P53M11	280	19.30€
--------	-----	--------

P53M18	460	31.00€
--------	-----	--------

P54M

Alicate de pressão para latoeiros

Ref.	Compr. (mm)	Preço
------	-------------	-------

P54M08A	205	13.00€
---------	-----	--------

P54M10A	250	16.70€
---------	-----	--------



P52N10

18.50€

Alicate de pressão boca larga

Comprimento: 240mm



P1019

17.00€

Alicate de pressão com corrente

Comprimento: 230mm

Capacidade: 457mm



P9409

14.80€

Alicate de pressão



P30M07C

12.50€

Alicate de pressão isolado

Comprimento: 175mm

Peso: 360g



P32M

Alicate de pressão isolado com mordentes curvos e corta fios

Ref.	Compr. (mm)	Peso (g)	Preço
P32M05C	125	175	10.80€
P32M10C	250	560	13.80€



P36M

Alicate de pressão isolado bicos longos com corta fios

Ref.	Compr. (mm)	Peso (g)	Preço
P36M06C	152	180	11.00€
P36M09C	270	560	13.00€



P78M10C

15.50€

Alicate de pressão isolado

Comprimento: 250mm



P32M03S

37.00€

Jogo de 3 alicates de pressão

Ref.	Caraterísticas	Compr. (mm)
P36M06S	Bicos longos	160
P32M07S	Bocas côncavas	180
P32M10S	Bocas côncavas	250



Alicates

com mola

P7801

23.30€

Alicate de pressão multifunções

Garras tipo W



P7802

23.30€

Alicate de pressão multifunções

Garras tipo JJ



P7803

23.00€

Alicate de pressão multifunções

Garras tipo LL



P7804

22.50€

Alicate de pressão multifunções

Garras tipo J



P7805

22.50€

Alicate de pressão multifunções





D70S

Chaves fenda de impacto

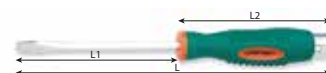

Ref.	Medida (mm)	L1 (mm)	L2 (mm)	L (mm)	Preço
D70S475	4	75	107	182	3.10€
D70S5100	5,5	100	107	207	3.90€
D70S6125	6,5	125	127	252	4.80€
D70S6150	6,5	150	127	277	5.20€
D70S8150	8	150	144	294	6.80€
D70S8175	8	175	144	319	7.10€
D70S9175	9,5	175	144	319	7.40€
D70S9250	9,5	250	144	394	8.60€

D70P

Chave phillips de impacto

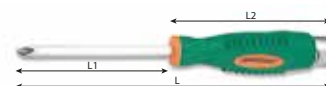

Ref.	Medida	L1 (mm)	L2 (mm)	L (mm)	Preço
D70P175	PH1	75	107	182	3.90€
D70P2100	PH2	100	127	277	4.60€
D70P3125	PH3	125	144	269	6.90€
D70P3150	PH3	150	144	299	7.30€

D70PP07S

42.00€

Jogo de 7 chaves fenda/ phillips de impacto

Composição/ medidas (mm):

- 3 Chaves fenda impacto: 5,5x100; 6,5x125 e 8x150
- 3 Chaves phillips: PH1x75; PH2x100 e PH3x125
- 1 Chave extensível com ponta magnética



D70PP10S

55.50€

Jogo de 10 chaves fenda/ phillips de impacto

Composição/ medidas (mm):

- D70S Chaves fenda: 5,5x100; 6,5x125; 8x150; 9,5x175 e 6,5x38
- D70P Chaves phillips: PH1x75; PH2x100; PH3x125 e PH2x38
- Ponteiro magnético



DV13PP-TP

2.80€

Busca-polos

220 - 250 v

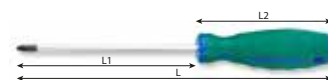

D71P
Chave phillips

Ref.	Medida	L1 (mm)	L2 (mm)	L (mm)	Preço
D71P060	PH0	60	90	150	2.25€
D71P138	PH1	38	56	94	2.15€
D71P180	PH1	80	110	190	2.45€
D71P238	PH2	38	56	94	2.15€
D71P1100	PH1	100	110	210	2.75€
D71P1150	PH1	150	110	250	2.95€
D71P1300	PH1	300	110	410	4.00€
D71P2100	PH2	100	119	219	3.10€
D71P2150	PH2	150	119	269	3.35€
D71P2250	PH2	250	119	369	5.00€
D71P2400	PH2	400	119	519	6.35€
D71P3150	PH3	150	129	279	4.30€
D71P3250	PH3	250	129	279	6.50€
D71P3400	PH3	400	129	529	8.30€
D71P4200	PH4	200	129	329	5.70€

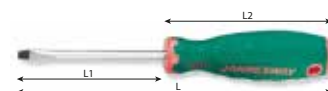
D71S
Chave fenda

Ref.	Medida (mm)	L1 (mm)	L2 (mm)	L (mm)	Preço
D71S250	2,4	50	72	122	2.00€
D71S360	3	60	72	132	2.05€
D71S4100	4	100	90	190	2.30€
D71S4150	4	150	110	260	3.20€
D71S4200	4	200	90	290	3.45€
D71S480	4	80	90	170	2.15€
D71S5125	5,5	125	110	235	2.70€
D71S5200	5,5	200	110	310	3.15€
D71S5300	5,5	300	110	410	4.35€
D71S538	5,5	38	56	94	2.35€
D71S575	5,5	75	110	185	2.70€
D71S638	6,5	38	56	94	2.15€
D71S6100	6,5	100	119	219	3.15€
D71S6150	6,5	150	119	269	3.35€
D71S6400	6,5	400	119	519	6.25€
D71S8150	8	150	129	279	4.30€
D71S8200	4	200	129	329	5.00€
D71S8300	8	300	129	429	6.15€
D71S8500	8	500	129	629	9.15€
D71S9175	9,5	175	129	304	4.75€
D71S10250	10	250			5.80€

D71T
Chave torx

Ref.	Medida	L1 (mm)	L2 (mm)	L (mm)	Preço
D71T5	T5	60	73	132	2.10€
D71T6	T6	60	73	132	2.10€
D71T7	T7	60	73	132	2.15€
D71T8	T8	60	73	132	2.15€
D71T9	T9	60	73	132	2.15€
D71T10	T10	80	90	170	2.20€
D71T15	T15	80	90	170	2.20€
D71T20	T20	100	110	210	2.55€
D71T25	T25	100	110	210	2.60€
D71T27	T27	100	119	219	3.50€
D71T30	T30	125	119	244	3.70€
D71T40	T40	150	129	279	4.70€
D71T45	T45	200	129	329	4.80€
D71T50	T50	200	129	329	5.60€

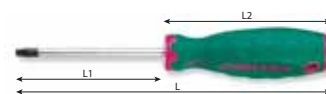
D71400T
Chave torx longa

Ref.	Medida	Compr. (mm)	Preço
D71400T10	T10	400	5.60€
D71400T15	T15	400	5.90€
D71400T20	T20	400	6.50€
D71400T25	T25	400	6.60€
D71400T30	T30	400	8.00€

D71Z
Chave pozi

Ref.	Medida	L1 (mm)	L2 (mm)	L (mm)	Preço
D71Z060	PZ0	60	90	150	2.15€
D71Z138	PZ1	38	56	94	2.25€
D71Z180	PZ1	80	110	190	2.55€
D71Z2100	PZ2	100	119	219	3.20€
D71Z3150	PZ3	150	129	279	4.60€
D71Z4200	PZ4	200	129	329	5.20€

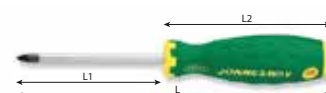
D725N
Chaves "T" de punho antideslizante com caixa sextavada

Ref.	Medida (mm)	Compr. (mm)	Preço
D725N06	6	298	5.50€
D725N07	7	298	5.50€
D725N08	8	298	5.50€
D725N09	9	298	5.70€
D725N10	10	298	5.70€
D725N11	11	298	5.80€
D725N12	12	298	6.00€
D725N13	13	298	6.00€



D715N

Chave caixa com punho



Ref.	Medida	L1 (mm)	L2 (mm)	L (mm)	Preço
D715N05	5	125	119	244	4.50€
D715N07	7	125	119	244	4.70€
D715N08	8	125	119	244	4.80€
D715N10	10	125	119	244	5.00€
D715N12	12	125	119	244	5.30€
D715N13	13	125	119	244	5.70€

D71C105S

16.00€

Jogo de 5 chaves fenda/ phillips

Composição/ medidas (mm):

Chaves fenda: 4x80; 5,5x125 e 6,5x150

Chaves phillips: PH1x80 e PH2x100

D71C106S

17.00€

Jogo de 6 chaves fenda/ phillips

Composição/ medidas (mm):

Chaves fenda: 3x60; 5,5x125 e 6,5x150

Chaves phillips: PH0x60; PH1x80 e PH2x100

D71PP08S

30.50€

Jogo de 8 chaves fenda/ phillips com punho antideslizante

Composição/ medidas (mm):

D71S Chaves fenda: 6,5x38; 4x80; 5,5x125 e 6,5x150

D71P Chaves phillips: PH2x38; PH1x80; PH2x100 e PH3x150

D71PP16S

64.00€

Jogo de 16 chaves fenda/ phillips com punho antideslizante

Composição/ medidas (mm):

D71S Chaves fenda: 6,5x38; 3x50; 6,5x100; 5,5x125; 5,5x200; 8,5x150; 5,5x75 e 4x150

D71P Chaves phillips: PH2x38; PH1x150; PH0x60; PH1x80; PH2x100; PH2x150; PH3x150 e PH1x38

D71T107S

23.20€

Jogo de 7 chaves torx com punho antideslizante

Composição/ medidas (mm):

Chaves: T10; T15; T20; T25; T27; T30 e T40

D71T109S

27.00€

Jogo de 9 chaves torx com punho antideslizante

Composição/ medidas (mm):

Chaves: T8; T9; T10; T15; T20; T25; T27; T30 e T40

D71Z105S

16.00€

Jogo de 5 chaves fenda/ pozi

Composição/ medidas (mm):

Chaves fenda: 4x80; 5,5x125 e 6,5x150

Chaves pozi: PZ1x80 e PZ2x100



**Chaves**

as pontas bits são vendidas em embalagens de 10 unidades
os Precios indicados são por unidade

D71Z107S

27.00€

Jogo de 7 chaves fenda/ pozi com punho antideslizante

Composição/ medidas (mm):

Chaves fenda: 4x100; 5,5x125; 6,5x150 e 8x175

Chaves pozi: PZ1x80; PZ2x100 e PZ3x150

**D3750P08S**

17.70€

Jogo de 8 chaves de precisão fenda/ phillips

Composição:

Ref.	Chave	Ponta (mm)	Compr. (mm)
D3750S30	fenda	3	50
D3750S24	fenda	2,4	50
D3750S20	fenda	2	50
D3750S16	fenda	1,6	50
D3750S10	fenda	1	50
D3750P1	phillips	nº1	50
D3750P0	phillips	nº0	50
D3750P00	phillips	nº00	50

**D3750T08S**

17.70€

Jogo de 8 chaves de precisão torx

Composição:

Ref.	Medida (mm)	Ref.	Medida (mm)
D3750T20	T20x50	D3750T8	T8x50
D3750T15	T15x50	D3750T7	T7x50
D3750T10	T10x50	D3750T6	T6x50
D3750T9	T9x50	D3750T5	T5x50

**D3750T18S**

15.50€

Jogo de 8 chaves de precisão

Composição:

Ref.	Medida (mm)	Ref.	Medida (mm)
D3750P00	P00x50	D3750T7	T7x50
D3750T4	T4x50	D3750A1	garfo 50
D3750T5	T5x50	D3750A2	inclinação 50
D3750T6	T6x50	D3750A3	agulha 50

**DR0253S**

46.90€

Jogo de bits e porta bits flexível

Composição/ medidas (mm):

Porta bits flexível

Bits phillips: #1; #2 e #3

Bits fenda: 3; 4; 5,5; e 7

Bits pozi: #0; #1; #2; e #3

Bits hexagonal: 2; 2,5; 3; 4; 5 e 6

Bits torx tAmper proof: T8; T10; T15; T20; T25; T27; T20 e

T40

Bits torx: T6; T8; T9; T10; T15; T20; T25; T27; T30 e T40

Adaptador 1/4" hexagonal

**DR0107S**

12.30€

Jogo de bits longos e porta bits

Composição/ medidas (mm):

Porta bits

Bits duplo 65mm

Pozi 1/ fenda 5mm

Pozi 2/ fenda 6mm

Pozi 3/ fenda 7mm

Hexagonal 3mm/ 4mm

Hexagonal 5mm/ 6mm

Phillips/ fenda 6mm



DBT31B

15.50€

Jogo de porta pontas de punho

Composição/ medidas (mm):

- Porta pontas de punho
- Pontas phillips
- Pontas fenda
- Pontas pozi
- Pontas hexagonais
- Pontas torx

RD01032S

32.00€

Jogo roquete com bits 1/4" com 32 peças

Composição:

- Roquete 1/4" de 60 dentes
- Porta bits magnético
- Bits phillips
- Bits hexagonais
- Bits quadrados
- Bits pozi
- Bits torx
- Bits fenda
- Bits torx tamperproof

S08H208S

6.30€

Jogo de porta pontas angular (90°)

Composição:

- 7 Pontas 1/4"

S14A4
Chave para retirar fêmeas danificadas 1/2"

Ref.	Medida (mm)	Comp. (mm)	Preço
S14A4117	17		10.00€
S14A4118	18,5		10.10€
S14A4120	20	25	10.40€
S14A4121	21,5		10.50€
S14A4123	23	30	11.00€
S14A4124	24,5	30	11.10€
S14A4126	26	30	11.30€
S14A4127	27,5	33	11.50€

S14A4108S

86.00€

Jogo de 8 chaves para retirar fêmeas danificadas 1/2"

Composição/ medidas (mm):

Chaves: 17; 18,5; 20; 21,5; 23; 24,5; 26 e 27,5

S29H2133S

11.70€

Jogo de porta bits 1/4" com 33 peças

Composição:

- Porta bits magnético
- Bits torx
- Bits torx tamperproof
- Bits perfil "Tri Wing"
- Bits perfil "Spanner"
- Bits hexagonais



D125P

Pontas/ bits de 1/4" phillips



Ref.	Medida (mm)	Compr. (mm)	Preço
D125P1F	PH1	25	0.30€
D125P2F	PH2	25	0.30€

D150P

Pontas/ bits de 1/4" phillips

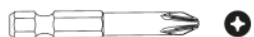

Ref.	Medida (mm)	Compr. (mm)	Preço
D150P1A	PH1	50	0.50€
D150P2A	PH2	50	0.50€
D150P3A	PH3	50	0.50€

D125Z

Pontas/ bits de 1/4" pozi



Ref.	Medida (mm)	Compr. (mm)	Preço
D125Z1A	PZ1	25	0.30€
D125Z2A	PZ2	25	0.30€
D125Z3A	PZ3	25	0.30€

D150Z

Pontas/ bits de 1/4" pozi

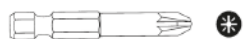

Ref.	Medida (mm)	Compr. (mm)	Preço
D150Z1A	PZ1	50	0.50€
D150Z2A	PZ2	50	0.50€
D150Z3A	PZ3	50	0.50€

D150F

Pontas/ bits de 1/4" fenda

Ref.	Medida (mm)	Compr. (mm)	Preço
D150F5510A	1x5,5	50	0.50€
D150F6512A	1,2x6,5	50	0.50€
D150F8012A	1,2x8	50	0.50€

D125H

Pontas/ bits de 1/4" hexagonais

Ref.	Medida (mm)	Compr. (mm)	Preço
D125H015A	1,5	25	0.30€
D125H020A	2	25	0.30€
D125H025A	2,5	25	0.30€
D125H030A	3	25	0.30€
D125H040A	4	25	0.30€
D125H050A	5	25	0.30€
D125H060A	6	25	0.30€

D130H

Pontas/ bits de 10mm hexagonais



Ref.	Medida (mm)	Compr. (mm)	Preço
D130H40	4	30	0.80€
D130H50	5	30	0.80€
D130H60	6	30	0.80€
D130H70	7	30	0.80€
D130H80	8	30	0.80€
D130H100	10	30	0.90€
D130H120	12	30	1.00€

D150H

Pontas/ bits de 1/4" hexagonais



Ref.	Medida (mm)	Compr. (mm)	Preço
D150H030A	3	50	0.50€
D150H040B	4	50	0.50€
D150H050A	5	50	0.50€
D150H060B	6	50	0.50€
D150H070B	7	50	0.60€
D150H080B	8	50	0.60€

D175H

Pontas/ bits de 10mm hexagonais



Ref.	Medida (mm)	Compr. (mm)	Preço
D175H40	4	75	1.25€
D175H50	5	75	1.25€
D175H60	6	75	1.25€
D175H70	7	75	1.30€
D175H80	8	75	1.35€
D175H100	10	75	1.30€
D175H120	12	75	1.70€

D10M

Pontas/ bits de 10mm estriado XZN



Ref.	Medida (mm)	Compr. (mm)	Preço
D10M30M05A	M5	30	0.80€
D10M30M06A	M6	30	0.80€
D10M30M08A	M8	30	0.80€
D10M30M10A	M10	30	0.80€
D10M30M12A	M12	30	1.00€
D10M30M14A	M14	30	1.10€
D10M75M05A	M5	75	1.30€
D10M75M06A	M6	75	1.30€
D10M75M08A	M8	75	1.30€
D10M75M10A	M10	75	1.30€
D10M75M12A	M12	75	1.73€
D10M75M14A	M14	75	1.89€

D125T

Pontas/ bits de 1/4" torx

Ref.	Medida (mm)	Compr. (mm)	Preço
D125T10A	T10	25	0.30€
D125T15A	T15	25	0.30€
D125T20A	T20	25	0.30€
D125T25A	T25	25	0.30€
D125T27A	T27	25	0.30€
D125T30A	T30	25	0.30€
D125T40A	T40	25	0.30€



D130T

Pontas/ bits de 10mm torx

Ref.	Medida (mm)	Compr. (mm)	Preço
D130T20	T20	30	0.80€
D130T25	T25	30	0.80€
D130T30	T30	30	0.80€
D130T40	T40	30	0.80€
D130T45	T45	30	0.80€
D130T50	T50	30	0.90€
D130T55	T55	30	0.90€



D150T

Pontas/ bits de 1/4" torx

Ref.	Medida (mm)	Compr. (mm)	Preço
D150T20A	T20	50	0.50€
D150T25A	T25	50	0.50€
D150T27A	T27	50	0.50€
D150T30A	T30	50	0.50€
D150T40A	T40	50	0.50€



D175T

Pontas/ bits de 10mm torx longo

Ref.	Medida (mm)	Compr. (mm)	Preço
D175T20	T20	75	1.25€
D175T25	T25	75	1.25€
D175T30	T30	75	1.25€
D175T40	T40	75	1.25€
D175T45	T45	75	1.25€
D175T50	T50	75	1.25€
D175T55	T55	75	1.30€



Chaves

D100MN

Ponta hexagonal magnética de 1/4" para fêmeas

Ref.	Medida (mm)	Compr. (mm)	Preço
D100MN08M	8	100	2.80€
D100MN10M	10	100	3.40€
D100MN12M	12	100	3.60€
D100MN13M	13	100	3.60€
D100MN14M	14	100	3.80€



D150MH

Porta pontas/ bits magnético para bits de 1/4"

Ref.	Medida (mm)	Compr. (mm)	Preço
D150MH1AD	10	50	2.00€

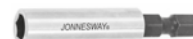

D150MH

Porta pontas/ bits magnético de encaixe rápido

Ref.	Medida (mm)	Compr. (mm)	Preço
D150MH1QD	10,5	50	4.50€



D165MN

Ponta hexagonal magnética de 1/4" para fêmeas

Ref.	Medida (mm)	Compr. (mm)	Preço
D165MN06M	6	65	1.95€
D165MN07M	7	65	1.95€
D165MN08M	8	65	2.00€
D165MN10M	10	65	2.50€
D165MN12M	12	65	3.10€
D165MN13M	13	65	3.10€



S29H2180S

32.50€

Conjunto de 180 pontas

Composição:

- Phillips
- Pozi
- Hexagonais
- Torx



Chaves

H01B

Chave hexagonal curta



Ref.	Medida (mm)	Preço
H01B1015	1,5	0.10€
H01B1020	2	0.10€
H01B1025	2,5	0.15€
H01B1030	3	0.18€
H01B1035	3,5	0.35€
H01B1040	4	0.45€
H01B1045	4,5	0.55€
H01B1050	5	0.60€
H01B1055	5,5	0.70€
H01B1060	6	0.70€
H01B1070	7	0.95€
H01B1080	8	1.10€
H01B1090	9	1.55€
H01B1100	10	1.75€
H01B1120	12	2.80€
H01B1140	14	4.00€
H01B1170	17	6.40€
H01B1190	19	9.00€
H01B1220	22	13.50€



H01SA

Chaves hexagonais curtas antideslizante

Ref.	Medida (mm)	L1 (mm)	L2 (mm)	Preço
H01SA115	1,5	46,5	15,5	0.40€
H01SA120	2	52	18	0.40€
H01SA125	2,5	58,5	20,5	0.40€
H01SA130	3	66	23	0.60€
H01SA140	4	74	29	0.90€
H01SA150	5	85	33	1.00€
H01SA160	6	96	38	1.50€
H01SA180	8	108	44	1.60€
H01SA1100	10	122	50	2.60€



H02MH217S

51.00€

Jogo de 17 chaves hexagonais longas SAE

Composição/ medidas:

Chaves: 1/16"; 5/64"; 3/32";
7/64"; 1/8"; 9/64"; 5/32"; 3/16";
1/4"; 5/16"; 3/8"; 7/16";
1/2"; 9/16"; 5/8" e 3/4"



H02SM109S

12.00€

Jogo de 9 chaves hexagonais longas

Composição/ medidas (mm):

Chaves: 1,5; 2; 2,5; 3; 4;
5; 6; 8 e 10



H01MH118S

33.70€

Jogo de 18 chaves hexagonais curtas

Composição/ medidas (mm):

Chaves: 1,5; 2; 2,5; 3; 3,5;
4; 4,5; 5; 5,5; 6; 7; 8; 9; 10;
12; 14; 17 e 19



H01SA109S

9.70€

Jogo de 9 chaves hexagonais curtas

Sistema especial antideslizante

Composição/ medidas (mm):

Chaves: 1,5; 2; 2,5; 3;
4; 5; 6; 8 e 10



H01SM109S

9.50€

Jogo de 9 chaves hexagonais curtas

Composição/ medidas (mm):

Chaves: 1,5; 2; 2,5; 3;
4; 5; 6; 8 e 10



H02SM209S

12.00€

Jogo de 9 chaves hexagonais longas SAE

Composição/ medidas:

Chaves: 1/16"; 5/64";
3/32"; 1/8"; 5/32";
3/16"; 1/4"; 5/16" e 3/8"



H03MH118S

61.50€

Jogo de 18 chaves hexagonais extra longas

Composição/ medidas (mm):

Chaves: 1,5; 2; 2,5; 3; 3,5; 4;
4,5; 5; 5,5; 6; 7; 8; 9;
10; 12; 14; 17 e 19



H03SM109S  13.30€

Jogo de 9 chaves hexagonais extra longas

Composição/ medidas (mm):

 Chaves: 1,5; 2; 2,5;
3; 4; 5; 6; 8 e 10

H05SA109S  13.00€

Jogo de 9 chaves hexagonais longas com ponta esférica antideslizante

Composição/ medidas (mm):

 Chaves: 1,5; 2; 2,5; 3;
4; 5; 6; 8 e 10

H06SA 

Chaves hexagonais extra longas com ponta esférica antideslizante

Ref.	Medida	L1 (mm)	L2 (mm)	Preço
H06SA115	1,5	91,5	15,5	0.60€
H06SA120	2	102	18	0.60€
H06SA125	2,5	114,5	20,5	0.60€
H06SA130	3	129	23	0.80€
H06SA140	4	144	29	1.10€
H06SA150	5	165	33	1.25€
H06SA160	6	186	38	1.85€
H06SA180	8	208	44	2.35€
H06SA1100	10	234	50	3.40€

H05SS109S  16.50€

Jogo de 9 chaves macho hexagonais com ponta esférica de baixo perfil

Composição/ medidas (mm):

 Chaves: 1,5; 2; 2,5; 3;
4; 5; 6; 8 e 10 mm

H06MT109S  17.20€

Conjunto de 9 chaves hexagonais longas com ponta esférica

Composição/ medidas (mm):

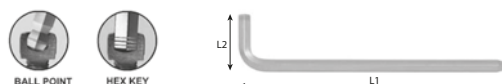
 Chaves: 1,5; 2; 2,5; 3;
4; 5; 6; 8 e 10 mm

H06SA109S  13.80€

Jogo de 9 chaves hexagonais macho extra longas com ponta esférica antideslizante

H06SM209S  14.90€

Jogo de 9 chaves hexagonais com ponta esférica SAE

Composição/ medidas (mm):

 Chaves: 1/16"; 5/64";
3/32"; 1/8"; 5/32"; 3/16";
1/4"; 5/16" e 3/8"

H07M09S  10.80€

Jogo de 9 chaves torx

Composição/ medidas (mm):

 Chaves: T10; T15; T20; T25;
T27; T30; T40; T45 e T50

H07MT 

Chave torx em L

Ref.	Medida	Preço
H07MT10	T10	0.80€
H07MT15	T15	0.90€
H07MT20	T20	1.00€
H07MT25	T25	1.10€
H07MT27	T27	1.20€
H07MT30	T30	1.30€
H07MT40	T40	1.40€
H07MT45	T45	1.70€
H07MT50	T50	2.10€

H08MTP09S  12.50€

Jogo de 9 chaves torx tamperproof

Composição/ medidas (mm):

 Chaves: T10; T15; T20; T25;
T27; T30; T40; T45 e T50

H08S110S



19.00€

Jogo de 10 chaves torx longas tamperproof

Composição/ medidas (mm):

Chaves: T9; T10; T15; T20; T25; T27; T30; T40; T45 e T50



H08ST



Chaves torx longas tamperproof

Ref.	Medida	Compr. (mm)	Preço
H08ST09085	T9	80	1.30€
H08ST10090	T10	90	1.30€
H08ST15100	T15	100	1.35€
H08ST20115	T20	112	1.45€
H08ST25130	T25	126	1.55€
H08ST27145	T27	142	1.65€
H08ST30165	T30	160	1.85€
H08ST40185	T40	180	2.25€
H08ST45205	T45	200	2.60€
H08ST50230	T50	224	3.35€



H10MB

Chave hexagonal dupla de punho com ponta esférica

Ref.	Medida	Preço
H10MB2100	2x100	2.40€
H10MB25100	2,5x100	2.45€
H10MB3100	3x100	2.45€
H10MB4100	4x100	2.50€
H10MB5150	5x150	2.90€
H10MB6150	6x150	3.25€
H10MB8200	8x200	5.00€
H10MB10200	10x200	6.30€



H10MB08S



32.00€

Jogo de 8 chaves hexagonais duplas de punho

Composição/ medidas (mm):

Chaves: 2x100; 2,5x100; 3x100; 4x100; 5x150; 6x150; 8x200 e 10x200



H10MT



Chave dupla de punho torx tamperproof

Ref.	Medida	Preço
H10MT10100	T10x100	2.60€
H10MT15100	T15x100	2.65€
H10MT20100	T20x100	2.70€
H10MT25100	T25x100	2.85€
H10MT27150	T27x150	3.00€
H10MT30150	T30x150	3.10€
H10MT40150	T40x150	3.80€
H10MT45200	T45x200	5.30€
H10MT50200	T50x200	5.70€

H10MT09S

36.50€

Jogo de 9 chaves duplas torx tamperproof com punho

Composição/ medidas (mm):

Chaves: T10x100; T15x100; T20x100; T25x100; T27x150; T30x150; T40x150; T45x200 e T50x200



H12S110S



18.80€

Jogo de 10 chaves torx longas

Composição/ medidas (mm):

Chaves: T9; T10; T15; T20; T25; T27; T30; T40; T45 e T50



H15M105S

14.00€

Jogo de 5 chaves estriadas em "L"

Composição/ medidas (mm):

Chaves: M5; M6; M8; M10 e M12



H12S

Chaves torx extra longa

Ref.	Medida	L1 (mm)	L2 (mm)	Preço
H12S09085	T9	85	5	1.10€
H12S10090	T10	90	5,5	1.10€
H12S15100	T15	100	8	1.20€
H12S20115	T20	115	12,5	1.30€
H12S25130	T25	130	18	1.40€
H12S27145	T27	145	24,5	1.60€
H12S30165	T30	165	40	1.90€
H12S40185	T40	185	62	2.30€
H12S45205	T45	205	98	2.60€
H12S50230	T50	230	128	3.50€

H20MT

Chaves torx dupla de punho

Ref.	Medida	L1 (mm)	L2 (mm)	Preço
H20MT10	T10	110	15	2.85€
H20MT15	T15	120	15	2.90€
H20MT20	T20	125	16	3.35€
H20MT25	T25	135	16	3.55€
H20MT27	T27	145	16	3.70€
H20MT30	T30	155	16	4.10€
H20MT40	T40	165	16	4.60€
H20MT45	T45	185	16	5.40€
H20MT50	T50	205	20	6.30€

H20MB1037S

53.50€
Jogo de 9 chaves hexagonais de ponta esférica com punho e 28 bits

Composição/ medidas (mm):

H20MB Chaves: H1,5X100; H2X100; H2,5X110; H3X120; H4X125; H5X155; H6X165; H8X185 e H10X210
 Bits phillips: PH1; PH2 e PH3
 Bits pozi: PZ1; PZ2 e PZ3
 Bits torx: T10; T15; T20; T25; T27; T30; T35 e T40
 Bits fenda: 3; 4; 5; 6 e 7
 Bits estriados: M4; M5 e M6
 Bits quadrados: 1; 2 e 3
 Bits spanner: 4 e 6

H06W106S

55.00€
Jogo de 6 chaves articuladas hexagonais de ponta redonda

Composição/ medidas (mm):

Chaves: 3; 4; 5; 6; 8 e 10

H20MT09S

49.00€
Jogo de 9 chaves torx duplas de punho

Composição/ medidas (mm):

Chaves: T10x110; T15x120; T20x125; T25x135; T27x145; T30x155; T40x165; T45x185 e T50x205



H22S109S

18.00€
Jogo de 9 chaves hexagonais extra longas estriadas

Especial para remover parafusos danificados

Composição/ medidas (mm):

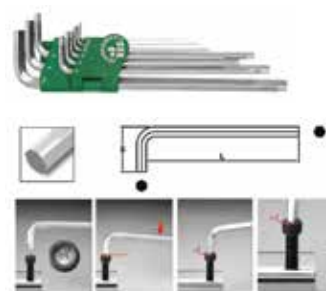
Chaves: 1,5; 2; 2,5; 3; 4; 5; 6; 8 e 10



Martelos

M03025

26.50€

Marreta metálica

Peso: 1 330g



M040

Martelo com batente redondo e pena esférica

Ref.	Peso (g)	Compr. (mm)	Preço
M04008	395	278	11.20€
M04012	527	283	12.00€
M04016	780	327	14.00€
M04024	1 063	383	18.60€
M04032	1 208	385	20.00€



M05020

16.80€

Martelo de orelhas

Peso: 830g

Comprimento: 330mm



M060

Marreta

Ref.	Peso (g)	Compr. (mm)	Preço
M06030	1 550	263	18.80€
M06040	2 250	276	21.50€



M07016

16.90€

Martelo de batentes plásticos

Peso: 840g

Comprimento: 314mm



M07016-ACE

2.75€

Batente amarelo de substituição M07016



M07016-TPR

1.50€

Batente preto de substituição M07016



JONNESWAY

M29

Martelo de batentes plásticos intermutáveis

Ref.	Diâmetro (mm)	Compr. (mm)	Preço
M2927	27	270	19.00€
M2940	40	330	32.50€



M2927

Batentes para martelo M2927

Ref.	Cor	Preço
M2927-T1	branco	2.20€
M2927-T2	amarelo	3.50€



M2940

Batentes para martelo M2940

Ref.	Cor	Preço
M2940-T1	branco	3.60€
M2940-T2	amarelo	5.40€



M09

Martelo de mecânico tipo "alemão"

Ref.	Peso (g)	Compr. (mm)	Preço
M09100	100	260	7.60€
M09200	200	280	8.40€
M09300	300	300	10.00€
M09500	500	320	12.20€
M09800	800	350	16.30€
M091000	1 000	360	20.00€



M110

Martelo anti recuo revestido a borracha

Ref.	Peso (g)	Compr. (mm)	Preço
M11035	400	260	14.50€
M11045	520	286	18.00€
M11065	1500	370	29.90€



M601
Punção de bico

Ref.	D (mm)	D1 (mm)	L (mm)	Preço
M60103	3	9,5	120	1.80€
M60104	4	9,5	120	2.10€
M60105	5	12	120	2.70€

M611
Talhadeira

Ref.	D (mm)	D1 (mm)	L (mm)	Preço
M61110	10	9,5	150	1.90€
M61112	12	9,5	130	2.20€
M61113	13	9,5	150	2.30€
M61116	16	12,7	180	3.50€
M61119	19	15,8	180	4.45€
M61122	22	15,8	200	4.75€
M61125	25	19	200	7.10€

M621
Punção

Ref.	D (mm)	D1 (mm)	L (mm)	Preço
M62102	2	9,5	120	1.60€
M62103	3	9,5	120	1.70€
M62104	4	9,5	120	1.60€
M62105	5	9,5	120	1.60€
M62106	6	9,5	120	1.60€
M62108	8	9,5	120	1.90€

M631
Saca troços

Ref.	D (mm)	D1 (mm)	L (mm)	Preço
M63102	2	8	115	1.95€
M63103	3	8	125	2.00€
M63104	4	9,5	150	2.25€
M63105	5	9,5	165	2.55€
M63106	6	12,7	180	3.05€
M63108	8	12,7	180	3.15€

M641
Buril

Ref.	D (mm)	D1 (mm)	L (mm)	Preço
M64105	5	9,5	130	2.85€

M61H1

Escopro com punho de proteção



Ref.	Medida (mm)	Compr. (mm)	Preço
M61H116	16	170	4.80€
M61H119	19	190	6.20€
M61H124	24	220	9.50€

M62H1

Punção com punho de proteção



Ref.	Medida (mm)	Compr. (mm)	Preço
M62H102	2	185	4.40€
M62H103	3	185	4.50€
M62H104	4	185	4.60€
M62H106	6	185	4.70€

M63106S

15.00€

Jogo de 6 saca troços

Composição/ medidas (mm):

2x8x115; 3x8x125;
4x9,5x150; 5x9,5x165;
6x12,7x180 e 8x12,7x180



M63H1

Saca troços com punho de proteção



Ref.	Medida (mm)	Compr. (mm)	Preço
M63H103	3	150	3.50€
M63H105	5	200	4.50€
M63H106	6	210	5.70€
M63H108	8	220	6.30€

M63M106S

16.80€

Jogo de 6 saca troços cromados

Composição/ medidas (mm):

2x8x115; 3x8x125; 4x9,5x150;
5x9,5x165; 6x12,7x180 e 8x12,7x180

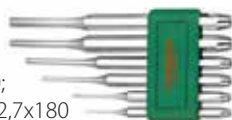

M64105S

11.30€

Jogo de 5 punções e escopros

Composição/ medidas (mm):

Punção: 2x8x115; 3x8x125;
4x9,5x150; 5x9,5x165; 6x12,7x180
Escopro: 8x12,7x180



M64M105S

10.90€

Jogo de 5 punções e escopros cromados

Composição/ medidas (mm):

Punção: 3x 9,5x120
Punção bico: 2x9,5x120
Talhadeira: 12x9,5x130
Saca troços: 4x9,5x150
Escopro: 5x9,5x130



MF05

Limas

Ref.	Tipo	Medida (mm)	Preço
MF05A	chata	200	7.70€
MF05B	redonda	200	6.50€
MF05C	meia cana	200	8.10€
MF05D	quadrada	200	7.50€
MF05E	triangular	200	7.50€

MF05S

44.70€

Jogo de 5 limas de 200mm

Composição:

MF05A Lima chata
MF05B Lima redonda
MF05C Lima meia cana
MF05D Lima quadrada
MF05E Lima triangular



MFM06S

23.00€

Jogo de 6 mini limas de 100mm

Composição:

Mini lima redonda
Mini lima triangular
Mini lima quadrada
Mini lima meia cana
Mini lima plana em bico



MHS100AG

16.90€

Serra



P9601

10.90€

Navalha corta cabos



MK2040

9.10€

X-ato com lâmina retrátil
Com 2 lâminas de substituição

MK2040-B

1.35€

Lâmina para x-ato MK2040 - 5 unidades

MK2080

10.00€

X-ato
Botão de segurança lâmina
Inclui 4 lâminas 18x100mm

MKS27

19.70€

Jogo de x-ato

Composição:
X-ato
Raspador
Acessórios

MKS27

Lâmina raspador - 100 unidades

Ref.	Tipo	Medida (mm)	Preço
MKS27-12	A	12	18.30€
MKS27-16	B	16	18.30€
MKS27-16A	C	(53°) 16	21.80€
MKS27-20	D	20	18.20€

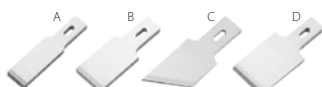
MT0701

3.70€

Fita métrica
Corpo em plástico ABS resistente ao choque
Comprimento: 3m

MT0702

4.60€

Fita métrica
Corpo em plástico ABS resistente ao choque
Comprimento: 5m

MT0703

8.00€

Fita métrica
Corpo em plástico ABS resistente ao choque
Comprimento: 8m

Diversos
MTC1

Paquímetro leitura vigésimal



Ref.	Compr. (mm)	Preço
MTC1150	150	38.00€
MTC1200	200	55.00€
MTC1300	300	95.00€

MTC153

14.20€

Esquadro metálico
Dimensões: 300x40x1mm

MTC156

2.60€

Régua metálica
Dimensões: 334x23,7x1mm

MTC200

96.00€

Paquímetro digital
Comprimento: 200mm

MTC3

Compasso de precisão pontas direitas

Ref.	Compr. (mm)	Preço
MTC306	150	15.80€
MTC308	200	17.80€

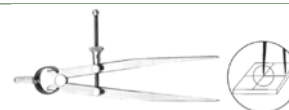
MTC408

17.50€

Compasso de precisão pontas curvas para exteriores
Comprimento: 200mm

MTC508

17.30€

Compasso de precisão pontas curvas para interiores
Comprimento: 200mm



MTM1

Micrómetro exteriores



Ref.	Medida (mm)	Preço
MTM1025	0-25	31.50€
MTM1050	25-50	36.00€
MTM1075	50-75	40.90€
MTM1100	75-100	47.50€

AG010207

75.00€

Gambiarras de Leds

Inclui: Carregador 220v AC/ 5v DC e cabo USB

Dimensões: 375x30x30mm Potência: 15W
 Carregador: 220v/ 50Hz Capacidade da bateria: 2,5 a 10h
 Fluxo luminoso: 410 lumen Tempo de carga: 3,5 a 4h
 Iluminância máxima: 935 lux projetada a 50cm
 Bateria recarregável: Li-ion 3,7v 2 200mAh



AG010224

68.00€

Gambiarras flexíveis de Leds

Comprimento: 168mm Bateria: Li-ion 3,7v - 2.2Ah
 Carregador: AC/DC Haste flexível 360°
 Base magnética Regulador de intensidade
 Autonomia: 2 a 8h (variável conforme intensidade)



C-DM1

22.00€

Barra magnética

Dimensões: 475x52x17mm



DV13P
Chave phillips isolada (1000 Volts)

Ref.	Medida	L1 (mm)	L2 (mm)	L (mm)	Preço
DV13P060	PH0	60	98	158	3.20€
DV13P180	PH1	80	104	184	4.10€
DV13P2100	PH2	100	110	210	4.50€
DV13P3150	PH3	150	120	270	5.50€

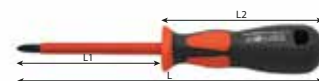
DV13S
Chave fenda isolada (1000 Volts)

Ref.	Medida (mm)	L1 (mm)	L2 (mm)	L (mm)	Preço
DV13S275	2,5	75	98	173	3.30€
DV13S3100	3x100	100	80	180	3.60€
DV13S4100	4	100	98	198	3.70€
DV13S5125	5,5	125	104	229	4.30€
DV13S6150	6,5	150	110	260	5.00€
DV13S8175	8x175	175	120	295	6.00€

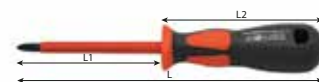
DV13Z
Chave pozi isolada (1000 Volts)

Ref.	Medida (mm)	L1 (mm)	L2 (mm)	L (mm)	Preço
DV13Z060	PZ0x60	60	98	158	3.50€
DV13Z180	PZ1x80	80	104	184	4.20€
DV13Z2100	PZ2x100	100	110	210	4.70€
DV13Z3150	PZ3x150	150	120	270	6.00€

DV13PP07S
33.50€
Jogo de chaves isoladas fenda/ phillips (1000 Volts)

Composição/ medidas (mm):

 Chaves fenda: 4x100; 5,5x125 e 6,5x150
 Chaves phillips: PH0x60; PH1x80 e PH2x100
 Busca-polos

DV41M
Chaves de caixa isoladas com punho (1000 Volts)

Ref.	Medida	Compr. (mm)	Preço
DV41M5	M5	125	6.10€
DV41M6	M6	125	6.30€
DV41M7	M7	125	6.30€
DV41M8	M8	125	6.40€
DV41M10	M10	125	6.50€
DV41M13	M13	125	6.90€

DV4118SV
148.00€
Tabuleiro EVA com ferramentas isoladas (1000 volts)

Composição:

Ref.	Chave	Medida (mm)
DV13S275	fenda	2,5x75
DV13S3100	fenda	3x100
DV13S4100	fenda	4x100
DV13S5125	fenda	5,5x125
DV13P060	phillips	PH0x60
DV13P180	phillips	PH1x80
DV13P2100	phillips	PH2x100
DV13P3150	phillips	PH3x150
DV41M	caixa punho	M4x125; M5x125; M5,5x125; M6x125; M7x125; M8x125; M9x125; M10x125; M11x125 e M12x125

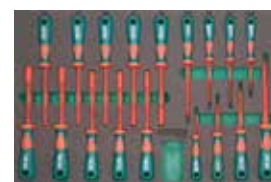

DV41M06S 40.00€

Jogo de 6 chaves de caixa isoladas com punho (1000 Volts)

Composição/ medidas:

Chaves caixa: M5; M6; M7; M8; M10 e M13



MKV7 10.00€

X-ato isolado 1000V

Comprimento: 180mm

Lâmina: 50mm



MKV7-K 14.00€

Lâmina para x-ato isolado 1000 volts - 4 unidades



MKV8 16.30€

Navalha isolada 1000V

Comprimento: 180 mm

Lâmina: 50mm



PV0118 21.20€

Alicate universal

Cumprre a norma IEC 60900

Compr. (mm)	4.0	3.0	2.0	1.6
200				



PV08

Alicate universal isolado (1000 volts)

Cumprre a norma IEC 60900

Ref.	Compr. (mm)	4.0	3.0	2.0	1.6	Preço
PV0816	160					16.00€
PV0817	180					17.50€



PV0518 23.50€

Alicate corta cabos (trabalho intensivo)

Cumprre a norma IEC 60900

Comprimento: 200mm

Capacidade de corte: Ø13/60mm



PV0918 21.00€

Alicate de corte

Cumprre a norma IEC 60900

Compr. (mm)	4.0	3.0	2.0	1.6
200				



PV1016 17.50€

Alicate de corte diagonal

Cumprre a norma IEC 60900

Compr. (mm)	4.0	3.0	2.0	1.6
160				



PV1116 17.00€

Alicate de pontas redondas isolado (1000 volts)

Cumprre a norma IEC 60900

Comprimento: 160mm



PV1118 17.50€

Alicate de pontas

Cumprre a norma IEC 60900

Compr. (mm)	4.0	3.0	2.0	1.6
200				



PV1218 20.20€

Alicate de pontas redondas

Cumprre a norma IEC 60900

Compr. (mm)	4.0	3.0	2.0	1.6
200				



PV1416 16.00€

Alicate de pontas chatas

Cumprre a norma IEC 60900

Comprimento: 160mm



PV1516 15.70€

Alicate de descarnar fios (trabalho intensivo)

Cumprre a norma IEC 60900

Comprimento: 160mm



PV28110 24.00€

Alicate ajustável

Cumprre a norma IEC 60900

Comprimento: 275mm



PV4006

19.40€

Alicate de pontas redondas
Cumpra a norma IEC 60900
Comprimento: 200mm

PSV108SP

84.00€

Jogo de 3 alicates e 5 chaves isoladas 1 000V

Composição/ medidas em mm:

- PV087 Alicate universal
- PV1108 Alicate universal de pontas
- PV106 Alicate de corte 5,5x125
- DV1SPP-TP Busca-polos 220-250v
- DV13S5125 Chave fenda 5,5x125
- DV13S6150 Chave fenda 6,5x150
- DV13P180 Chave phillips P1x80
- DV13P2100 Chave phillips P2x100

B

PSV110SC

140.00€

Jogo de 10 ferramentas isoladas 1 000V

Composição:

- 4 Alicates
- 4 Chaves de fenda/ phillips
- 1 Navalha
- 1 Busca-polos

C

S03V21

Chaves de caixa 1/4" com isolamento a 1 000V



Ref.	Medida (mm)	Compr. (mm)	Preço
S03V2106	6	41	4.50€
S03V2108	8	41	4.70€
S03V2110	10	41	4.90€
S03V2114	14	41	5.20€

S03V31

Chaves de caixa 3/8" com isolamento a 1 000V



Ref.	Medida (mm)	Compr. (mm)	Preço
S03V3108	8	44,5	6.50€
S03V3110	10	44,5	6.60€
S03V3112	12	44,5	7.00€
S03V3113	13	44,5	7.20€
S03V3114	14	44,5	7.40€
S03V3117	17	44,5	7.90€
S03V3119	19	46	8.20€
S03V3122	22	46	9.00€

S03V41

Chaves de caixa 1/2" com isolamento a 1 000V



Ref.	Medida (mm)	Compr. (mm)	Preço
S03V4110	10	55	8.00€
S03V4111	11	55	8.30€
S03V4112	12	55	8.50€
S03V4113	13	55	8.60€
S03V4114	14	55	9.00€
S03V4117	17	55	9.10€
S03V4119	19	57	9.20€
S03V4122	22	57	10.00€
S03V4124	24	57	10.30€
S03V4127	27	59	12.00€
S03V4132	32	59	15.00€

S03V3116SC

230.00€

Jogo de 16 peças 3/8" com roquete isolado a 1 000V

Composição/ medidas em mm:

- RV033 Roquete isolado 200
- S43V38 Cabo "T" 200
- S25V36 Extensão 150
- S25V310 Extensão 250
- S03V3 Chaves de caixa: 8; 10; 12; 13; 14; 17; 19 e 22
- S09V3 Bits: 4; 5; 6 e 8

B

S03V3136SV

412.00€

Tabuleiro EVA com ferramentas de 1/4" e 3/8" isoladas a 1 000V

Composição/ medidas em mm:

- RV032 Roquete de 1/4"
- RV033 Roquete de 3/8"
- S43V28 Cabo "T" de 1/4" de 125
- S43V38 Cabo "T" de 3/8" de 200
- S25V24 Extensão de 1/4" de 100
- S25V3 Extensão de 3/8" de 150 e 250
- S03V21 10 Chaves de caixa: 5 a 14
- S03V31 11 Chaves de caixa: 8 a 22
- S09V2H 4 Bits de caixa de 1/4" de 60
- S09V3H 4 Bits de caixa de 3/8" de 60



S03V4120SC

320.00€

Jogo de 20 peças 1/2" com roquete isolado a 1 000V

Composição/ medidas em mm:

- RV034 Roquete isolado 250
- S43V48 Cabo "T" 200
- S25V45 Extensão 125
- S25V410 Extensão 250
- S03V4 Chaves de caixa: 10; 11; 12; 13; 14; 17; 19; 22; 24; 27 e 32
- S09V4 Bits: 4; 5; 6; 8 e 10



S03V4124SV

370.00€

Tabuleiro EVA com ferramentas de 1/4" e 3/8" isoladas a 1 000V

Composição/ medidas em mm:

- RV034 Roquete de 1/2"
- S43V48 Cabo "T" de 1/2" de 200
- S25V4 Extensão de 125 e 250
- S03V41 13 Chaves de caixa: 10 a 32
- S09V41H 5 Bits de caixa de 200
- WV27AS8 Chave inglesa de 150
- MKV7 X-acto



S09V3H



Chaves de caixa hexagonal 3/8" com isolamento a 1 000V

Ref.	Medida (mm)	Compr. (mm)	Preço
S09V3H4	4	60	6.50€
S09V3H5	5	60	6.70€
S09V3H6	6	60	7.00€
S09V3H8	8	60	7.80€

S09V41H



Chaves de caixa 3/8" com isolamento a 1 000V

Ref.	Medida (mm)	Compr. (mm)	Preço
S09V41H4	4	120	9.00€
S09V41H5	5	120	9.20€
S09V41H6	6	120	9.50€
S09V41H8	8	120	9.80€
S09V41H10	10	120	10.50€

S25V3



Extensão 3/8" com isolamento a 1 000V

Ref.	Compr. (mm)	Peso (g)	Preço
S25V36	150	150	23.00€
S25V310	250	250	28.00€

S25V4



Extensão 1/2" com isolamento a 1 000V

Ref.	Compr. (mm)	Peso (g)	Preço
S25V45	150	210	27.00€
S25V410	250	410	29.00€

S43V
Cabo "T" com isolamento a 1 000V

Ref.	Quadra	Compr. (mm)	Peso (g)	Preço
S43V38	3/8"	200	240	34.00€
S43V48	1/2"	250	330	37.00€

RV03
Roquete com isolamento a 1 000V

Ref.	Quadra	Compr. (mm)	Peso (g)	Preço
RV032	1/4"	150	140	37.00€
RV033	3/8"	200	300	48.50€
RV034	1/2"	250	570	55.00€

W23V1
Chaves luneta com isolamento a 1 000V

Ref.	Medida (mm)	Compr. (mm)	Preço
W23V108	8	164	15.60€
W23V110	10	174	17.00€
W23V111	11	184	17.80€
W23V112	12	184	18.00€
W23V113	13	205	19.00€
W23V114	14	205	19.50€
W23V116	16	221	22.00€
W23V117	17	221	22.50€
W23V118	18	237	24.50€
W23V119	19	237	25.00€
W23V121	21	257	27.50€
W23V122	22	257	28.00€
W23V124	24	287	32.50€

W25V1
Chaves de boca 3/8" com isolamento a 1 000V

Ref.	Medida (mm)	Compr. (mm)	Preço
W25V108	8	104	12.00€
W25V109	9	104	12.50€
W25V110	10	114	13.00€
W25V113	13	154	14.00€
W25V114	14	154	14.50€
W25V117	17	170	15.50€
W25V118	18	180	17.00€
W25V119	19	180	17.50€
W25V121	21	202	21.50€
W25V122	22	202	22.00€
W25V124	24	237	23.00€

W25V1125SV
495.00€
Tabuleiro EVA com ferramentas isoladas a 1 000V

Composição/ medidas em mm:

W23V11	9 Chaves luneta 10 a 19mm
W25V	13 Chaves bocas 7 a 24mm
PV0818	Alicate universal 200mm
PV1016	Alicate de corte 160mm
PV1116	Alicate de pontas 160mm

WV27AS10
46.50€
Chave ajustável isolada 1000V

 Abertura: 33mm
 Comprimento: 200mm



JONNESWAY®

de Professionais para Profissionais



SGS Reference No: RA/2015/30009C

Page 1 of 1

VERIFICATION OF COMPLIANCE to the requirements of Machinery Directive 2006/42/EC

Verification Report No. : RA/2015/30009C
 Representative Model : JAI-1108, JAI-1056
 Series Model(s) : JAI-1108, JAI-1108L, JAI-1126, JAI-1128, JAI-0963, JAI-0964, JAI-0966, JAI-0923, JAI-0924, JAI-0926, JAI-0936, JAI-1044, JAI-1054, JAI-6280, JAI-0501, JAI-0405, JAI-6283, JAI-0803
 Product Name : Air Impact Wrench
 Applicant : JONNESWAY ENTERPRISE CO., LTD.
 Address of Applicant : 6F-9, No. 51, Sec. 2, Keelung Rd., Taipei, Taiwan
 TCF Number : JONNESWAY-20150301-V1
 Date of Issue : June 19, 2015
 Date of Expiry : June 18, 2020
 Applicable Standard(s) : EN ISO 12100 :2010, EN ISO 11148-6 :2012

Conclusion
 Based upon a review of the Technical Construction File, the apparatus is deemed to meet the requirements of the above standard(s) and hence fulfill the requirements of:

Machinery Directive 2006/42/EC

*Note : This verification is only valid for the apparatus and configuration described and in conjunction with the technical data detailed above.
 The CE mark as shown below can be used, under the responsibility of the manufacturer, after completion an EC Declaration of Conformity and compliances with all relevant EC Directives.*

Authorized Signatory:

SGS TAIWAN LTD.
 Jason Lin
 Technical Manager



SGS Reference No: RA/2019/60012C

Page 1 of 1

VERIFICATION OF COMPLIANCE to the requirements of Machinery Directive 2006/42/EC

Verification Report No. : RA/2019/60012C
 Representative Model : JAI-1138L
 Series Model(s) : JAI-1138, JAI-1408, JAI-1408L, JAI-1418, JAI-1418L, JAI-1208, JAI-1208L, JAI-1206, JAI-1206L, JAI-1218, JAI-1218L, JAI-1114, JAI-1124, JAI-1024, JAI-1014, JAI-1313, JAI-1314, JAI-6259, JAI-6259-8, JAI-6225, JAI-6225-8, JAI-6276, JAI-6276L, JAI-6277, JAI-6277L, JAI-6211, JAI-6211L, JAI-6212, JAI-6212L, JAI-1513, JAI-1514, JAI-0954, JAI-1524
 Product Name : AIR IMPACT WRENCH
 Applicant : JONNESWAY ENTERPRISE CO., LTD
 Address of Applicant : 6F-9, NO.51, SEC. 2, KEELUNG RD., TAIPEI TAIWAN
 TCF Number : JONNESWAY-201906-J1
 Date of Issue : June 25, 2019
 Date of Expiry : June 25, 2024
 Applicable Standard(s) : EN ISO 12100 :2010, EN ISO 11148-6:2012

Conclusion

Based upon a review of the Technical Construction File, the apparatus is deemed to meet the requirements of the above standard(s) and hence fulfill the requirements of:

Machinery Directive 2006/42/EC

Note : This verification is only valid for the apparatus and configuration described and in conjunction with the technical data detailed above.

The CE mark as shown below can be used, under the responsibility of the manufacturer, after completion an EC Declaration of Conformity and compliances with all relevant EC Directives.

Authorized Signatory:

SGS TAIWAN LTD.
 Jason Lin
 Technical Manager



This document is issued by the Company subject to its General Conditions of Service printed overleaf, available on request or accessible at <http://www.sgs.com/en/Terms-and-Conditions.aspx> and, for electronic format documents, subject to Terms and Conditions for Electronic Documents at <http://www.sgs.com/en/Terms-and-Conditions.aspx?document=sgs>. Attention is drawn to the limitation of liability, indemnification and jurisdiction issues defined therein. Any holder of this document is advised that information contained herein reflects the Company's findings at the time of its intervention only and within the limits of Client's instructions, if any. The Company's sole responsibility is to its Client and this document does not exonerate parties to a transaction from exercising all their rights and obligations under the transaction documents. This document cannot be reproduced except in full, without prior written approval of the Company. Any unauthorized alteration, forgery or falsification of the content or appearance of this document is unlawful and offenders may be prosecuted to the fullest extent of the law. Unless otherwise stated the results shown in this test report refer only to the sample(s) tested. TWB 4262448

SGS Taiwan Ltd. | 134, Wu Kung Road, Wu Ku District, New Taipei City, Taiwan / 新北市五股區五工路134號
 台灣檢驗科技股份有限公司 | (886-2) 2289-3939 | (886-2) 2289-2699 | www.sgs.tw
 Member of SGS Group

This document is issued by the Company subject to its General Conditions of Service printed overleaf, available on request or accessible at <http://www.sgs.com/en/Terms-and-Conditions.aspx> and, for electronic format documents, subject to Terms and Conditions for Electronic Documents at <http://www.sgs.com/en/Terms-and-Conditions.aspx?document=sgs>. Attention is drawn to the limitation of liability, indemnification and jurisdiction issues defined therein. Any holder of this document is advised that information contained herein reflects the Company's findings at the time of its intervention only and within the limits of Client's instructions, if any. The Company's sole responsibility is to its Client and this document does not exonerate parties to a transaction from exercising all their rights and obligations under the transaction documents. This document cannot be reproduced except in full, without prior written approval of the Company. Any unauthorized alteration, forgery or falsification of the content or appearance of this document is unlawful and offenders may be prosecuted to the fullest extent of the law. Unless otherwise stated the results shown in this test report refer only to the sample(s) tested. TWB 4260788

SGS Taiwan Ltd. | 134, Wu Kung Road, Wu Ku District, New Taipei City, Taiwan / 新北市五股區五工路134號
 台灣檢驗科技股份有限公司 | (886-2) 2289-3939 | (886-2) 2289-2698 | www.sgs.tw
 Member of SGS Group

1008



JONNESWAY[®]

**Ferramenta Especial
Mecânica**



Mecânica



Pesados



Motociclos



Acessórios



Chapeiro

Ferramenta específica - ramo automóvel
AB030056 35.20€

Insuflador de ar para abertura de portas

Comprimento: 230mm

AB030061 21.20€

Ferramenta para retirar braço do limpa parabrisas

AE040020 58.00€

Cilindro hidráulico

Comprimento: 140mm fechado | 215mm estendido

Capacidade: 2t

AE150005 99.00€

Par de preguiças de 3t com apoio em borracha

Altura máxima: 440mm

Altura mínima: 290mm

AE300064 208.00€

Kit teste de pressão para radiadores com 17 peças

Composição:

AE30064-02 Audi A4, A5, A6

AE30064-03 Opel, Ford, VW

AE30064-04 BMW

AE30064-05 BMW

AE30064-06 Volvo, Citroën, Renault, Fiat, Peugeot

AE30064-07 Audi, VW

AE30064-08 Sede ajustável

AE30064-09 Pino união 50mm

AE30064-10 Pino união 35mm

AE30064-11 Pino união 27mm

AE30064-12 Adaptador para 8; 9 e 11

AE30064-13 Adaptador

AE30064-14 Fixador

AE30064-15 Honda, Toyota

AE30064-16 Mitsubishi, Honda, Ford, Nissan, Mazda

AE3000

Adaptadores para teste radiadores

Ref.	Preço
AE300064-02	18.30€
AE300064-03	18.30€
AE300064-04	18.30€
AE300064-05	18.30€
AE300064-06	14.70€
AE300064-07	14.70€
AE300064-15	22.00€
AE300064-16	22.00€

AE300100-040 20.50€

Adaptador para kit de pressão de radiadores - Ford

Aplicável no kit AE300064

AE300100-042 20.50€

Adaptador para kit de pressão de radiadores - Ford

Aplicável no kit AE300064

AE300100-060 22.00€

Adaptador para kit de pressão de radiadores - Mercedes

Aplicável no kit AE300064

AE300103 15.90€

Aparadeira de chão para óleo

Dimensões: 600x450x180mm

Capacidade: 16l

AE300152 173.50€

Kit teste de pressão do radiador com 5 peças



AE300173

18.00€

Sangrador de fluido de embraiagem e travões
Fácil, rápido e eficiente utilizando o ar dos pneus



AE300176-A

49.00€

3 Adaptadores especiais para VW/ Audi/ Mercedes



AE300212

110.00€

Distribuidor de óleo de transmissões

Dimensões: 240x200x440mm
Capacidade: 4l
Peso: 1 600g
Bomba manual e 4 adaptadores



AE310002

237.00€

Conjunto de saca hidráulico com acessórios
Capacidade: 90-145mm



AE310006

89.00€

Conjunto de 2 extratores
Capacidade: 30-75mm



AE3100

Separadores meia lua

Ref.	Medida (mm)	Preço
AE310024	30-50	19.00€
AE310025	50-75	27.00€
AE310026	75-105	43.00€
AE310027	105-150	100.00€



AE310008

147.00€

Extrator interior e exterior

Capacidade: 15-30 e 30-80mm interna
15-80mm externa



AE310010A

104.00€

Jogo de extrator semieixo



AE310013

80.00€

Extrator universal de cubo roda

Capacidade: 90-140 e 130-180mm



AE310014

155.00€

Extrator de cubo roda e semieixo

Capacidade: 90-140 e 130-180mm



AE310016

45.50€

Extrator semieixo



AN010045

8.40€

Separador de rótulas



AE3100

Saca de 3 pernas

Ref.	Tamanho	Abertura (mm)	Capacidade (t)	Preço
AE310034	3"	40-76	2	17.80€
AE310035	4"	50-102	5	25.50€
AE310037	8"	80-203	12	96.00€
AE310038	12"	120-305	18	215.00€

AE310023

41.50€

Extrator de rótulas



AE310062

54.50€

Saca rolamentos longo

Comprimento: 300mm
Capacidade: 10-50mm



AE310063

65.00€

Saca para pequenos rolamentos

Especialmente indicado para remoção de pequenos rolamentos na área automóvel, reparação de equipamentos industriais e domésticos

Capacidade: 1t
Abertura: 19 a 45mm
Profundidade alcance: 73mm



AE310087

73.50€

Extrator universal de rótulas

Especialmente concebido para situações de utilização em espaço reduzido

Aplicável: Audi, VW, BMW, Ford, Mercedes (W170, W202, W210, W220), Opel, Mitsubishi ...



AE310099

107.00€

Extrator 7" de 2 ou 3 pernas para interiores e exteriores

Capacidade: 20t
Abertura: 76-178mm



Alterável para:



AE310066

23.50€

Extrator para volantes de direção

Aplicável: Opel, Ford entre outros



AE310122

83.50€

Extrator de rótulas

Abertura: 32mm



AE310073

27.00€

Extrator de rótulas

Abertura: 20mm



AE310150

66.00€

Saca polies



AE310077

31.80€

Extrator de rótulas

Abertura: 20mm



AE3101
Extrator de rótulas

Ref.	Ø (mm)	Largura (mm)	Altura (mm)	Preço
AE310109	18	40	35	30.00€
AE310110	23	50	45	37.70€
AE310112	40	80	80	75.00€

AE3101
Saca de 2 braços

Ref.	Ajuste Int. (mm)	Ajuste Ext. (mm)	Altura (mm)	Preço
AE310146B	25-80	70-130	100	45.90€
AE310146D	50-160	105-220	150	79.50€
AE310146E	60-200	120-270	150	107.00€

AE310172
Jogo de sacas

Composição:

Saca de 2ton

Pernas curtas: 85mm

Pernas compridas: 185mm

Saca de 6ton

Pernas curtas: 140mm

Pernas compridas: 280mm

Cilindro de 30ton

734.00€

AE310180
Jogo de saca rótulas com acessórios ajustáveis

Abertura: 20; 22; 24; 27 e 30mm



250.00€

AE310183
Removedor da barra de direção

105.00€

AE320023
Compressor de molas para amortecedores

Abertura: 270mm



35.50€

AE320034
Jogo de extrator de molas MacPherson

464.50€

AE320035
Torno para fixação MacPherson

140.00€

AE320044
Compressor de molas para amortecedores

Abertura: 300mm



56.00€

AE300154B

102.00€

Refratómetro

Aparelho apto para testar líquido de baterias, líquido refrigerante e AdBlue



AE300168

97.00€

Verificador de fugas da cabeça do cilindro

Equipamento destinado a verificar fugas na combustão.

A utilização de líquido contrastante permite verificar a existência de dióxido de carbono no depósito do líquido de refrigeração, denunciando assim a existência de fugas na combustão.



AE300168-1

35.00€

Líquido para verificador da cabeça do cilindro

Embalagem de 250ml

AE300201

108.00€

Pistola tornado vaporizadora

Dimensões: 330x105x270mm

Capacidade copo: 1l

Peso: 780g

Ruído: 85dB

Alimentação: 6,2bar

Consumo de ar: 56,6l/min

Entrada de ar: 1/4"



AE300202

105.00€

Pistola tornado vaporizadora/ espuma

Dimensões: 330x105x260mm

Capacidade copo: 1l

Peso: 950g

Ruído: 70dB

Alimentação: 6,2bar

Entrada de ar: 1/4"

Consumo de ar: 56,6l/min



AE300204

20.40€

Seringa para fluidos

Fabricado em plástico resistente a fluido travões e anticongelante.

Permite sucção, adição e visualização do fluido

Capacidade: 200cc

Peso: 294g

NÃO utilizar com combustíveis



AE300205

46.00€

Seringa para fluidos

Fabricado em plástico resistente a fluido travões e anticongelante.

Permite sucção, adição e visualização do fluido

Capacidade: 1,5l

Peso: 900g

Aplicação: óleo da caixa velocidades e diferenciais

NÃO utilizar com combustíveis



AE300211

79.60€

Seringa para fluidos com 5 adaptadores

Fabricado em plástico resistente e aplicável a todos os tipos de óleos e combustíveis. Permite sucção, adição e visualização do fluido.

Capacidade: 1,5l



AE300206

13.70€

Base de recolha de óleos para latas 20/ 30l

Concebido para recolha de restos de óleo de filtros, novo ou usado, e outros recipientes (encaixe direto em latas de 20/ 30l)

Fabricado em polietileno resistente de alta densidade

Capacidade: 3l

Peso: 500g

Diâmetro: 350mm



AE300207

45.00€

Base de recolha de óleos para bidons 200l

Concebido para recolha de restos de óleo de filtros, novo ou usado, e outros recipientes (encaixe direto no topo de bidons de 200l)

Fabricado em polietileno resistente de alta densidade

Capacidade: 20l

Peso: 1 700g

Diâmetro: 600mm



AE300215

33.70€

Pistola de limpeza de motores

Bico ajustável

Capacidade: 1l

Consumo de ar: 160 l/m

Entrada de ar: 1/4"

Pressão de trabalho: 5-8 Bar



AE300220

66.00€

Escorredor de resíduos de óleo

Dimensões: 174x197x486mm
Capacidade: 2l



AG010034

5.80€

Caneta magnética

Comprimento: 580mm



AG010035

18.90€

Pesca magnético com luz e espelho



AG010164

35.00€

Kit de pesca magnético com luz e espelho

Luz: branca, azul e UV



AG010046

7.70€

Ponteira para válvulas dos pneus

Comprimento: 230mm



AG010159

5.00€

Ponteira para mangueira de ar dos pneus



AG010059

27.00€

Jogo de 4 saca casquilhos

Medidas: 6; 8; 10 e 12mm



AG010059

Saca casquilhos

Ref.	Medida (mm)	Preço
AG010059-6	6	5.80€
AG010059-8	8	5.80€
AG010059-10	10	6.30€
AG010059-12	12	6.30€

AG010036

7.50€

Bandeja magnética redonda

Dimensões: Ø 150mm



AG010111

23.50€

Bandeja magnética retangular

Dimensões: 240x140mm



AS-0065

32.00€

Suporte magnético para máquina de impacto e 4 chaves



AG010049

8.20€

Jogo de 5 saca pernos



AG010089

15.00€

Medidor digital de pressão de ar

Baterias de lítio
Visor LCD
Auto calibração
Auto off



AG010099

27.50€

Chaves de cruz para porcas de rodas

Medidas: 17; 19 e 21mm



AG010225

24.00€

Chave de rodas com 3 peças

Pode ser utilizado em + ou em "T"

Medidas: 17; 19 e 21mm

Tubo perfurado 355mm com chave de 19 e 21mm
Tubo perfurado 395mm com chave de 17mm
Adaptador 1/2"



AG010109

16.50€

Quebra porcas

Medidas: 12-18 e 16-22mm



AG010118A

21.20€

Medidor angular de torque 1/2"



AG010147

11.70€

Chave de aperto angular de torque 1/2"



AG010208

53.00€

Jogo de extratores de parafusos torx danificados com 8 peças

Composição:

Medida (mm)	Compr. (mm)	Hex (mm)
3	38	10
4	38	10
5	38	10
6	38	10
7	38	12
8	38	12
10	38	14
12	38	14



AG10001SP-G

3.70€

Medidor de passo de rosca



AG010227

270.00€

Jogo de machos e caçonetos com 53 peças

Composição:

- 15 Machos 38mm: M6x0,75; M6x1,0; M8x1,0; M8x1,25; M10x1,25; M10x1,5; M12x1,25; M12x1,5; M12x1,75; M14x1,5; M14x2,0; M16x1,5; M16x2,0; M18x1,5 e M18x2,5
- 6 Machos 50mm: M20x1,5; M20x1,5; M22x1,6; M22x2,5; M24x1,5 e M24x3,0
- 21 Caçonetos: M6x0,75; M6x1,0; M8x1,0; M8x1,25; M10x1,25; M10x1,5; M12x1,25; M12x1,5; M12x1,75; M14x1,5; M14x2,0; M16x1,5; M16x2,0; M18x1,5; M18x2,5; M20x1,5; M20x2,5; M22x1,5; M22x2,5; M24x1,5 e M24x3,0

- 5 Extratores
- 1 Porta caçonetos
- 1 Desandador de machos (M6 - M25)
- 1 Desandador de machos (M4 - M12)
- 1 Chave phillips PH2 38mm
- 2 Adaptadores de Ø 50mm



AG010229

132.00€

Jogo de machos e caçonetos com 50 peças

Composição:

- 22 Machos + M3x0,5; M3x0,6; M4x0,7; M4x0,75; M5x0,8; M5x0,9
- 22 Caçonetos: M6x0,75; M6x1,0; M7x0,75; M7x1,0; M8x1,0; M8x1,25; M9x1,0; M9x1,25; M10x1,0; M10x1,25; M10x1,5; M11x1,5; M12x1,25; M12x1,5; M12x1,75 e 1/8NPT27

- 1 Desandador de machos M6 - M12
- 1 Desandador em "T" para machos
- 1 Porta caçonetos
- 1 Chave phillips
- 1 Medidor passo rosca
- 1 Punção



AG10001SP-T

2.70€

Desandador em T para machos



AG10001SP-W
7.70€
Desandador macho extensível

Medidas: M4 a M12

AG10002SC-W
5.10€
Desandador macho extensível

Medidas: M3 a M12

AH020002
20.40€
Proteção de guarda-lamas com fixação magnética

Dimensões: 1 050x650mm

AI010006
23.50€
Ferramenta para bloqueio de polias e carretos

AI010009
22.00€
Ferramenta para limpeza das ranhuras de segmentos

Com 3 lâminas circulares para limpeza de pistões (diâmetro: 51 a 127mm)

Lâmina 1: 1/16"; 5/64"; 3/32"; 1/8"; 5/32" e 3/16"

Lâmina 2: 2; 2,5; 3; 4; 4,5mm e 1/4"

Lâmina 3: 1,2; 1,5; 1,8; 2,8; 5 e 5,5mm

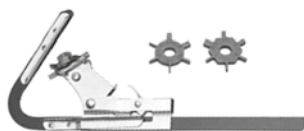
AI010023
11.80€
Esticador de correias

AI010029
67.50€
Saca carretos e polias

AI010030
79.00€
Chave bloqueio da polie da árvore de cames

AI010037
844.00€
Kit comando de motores com 8 peças

Composição:

Marca	Modelo	Aplicação
OPEL	Astra Vectra	G 1.7 TD; 2.0 16V 1.8; 2.0 16V >1995

OPEL	Astra Vectra Zafira	G 1.4; 1.6; 1.8 16V 1.6; 1.8 16V 1.6; 1.8 16V
------	---------------------------	---

Árvore de cames à direita

SAAB	900 - 9000	
------	------------	--

OPEL	Calibra Cavalier Omega-B Sintra Vectra	2.5; 2.5L; 2.6 V6 2.5L V6 2.5; 2.5L; 2.6 V6 2.5; 2.6; 3.0; 3.2; V6 3.0 V6 2.5L; 2.6 V6
------	--	--

Árvore de cames à esquerda

SAAB	900 - 9000	
------	------------	--

OPEL	Calibra Cavalier Omega-B Sintra Vectra	2.5; 2.5L; 2.6 V6 2.5L V6 2.5; 2.5L; 2.6 V6 2.5; 2.6; 3.0; 3.2; V6 3.0 V6 2.5L; 2.6 V6
------	--	--

ROVER	25 45 75 200 214 216 218 414 416	1.4; 1.6; 1.8VVC 1.4; 1.6; 1.8 1.8 VI 16V 16V; Cabrio; Coupé Coupé 16V 16V; BRM 1.8VVC
-------	--	--

VOLKSWAGEN	Bora Golf Lupo Polo Passat	1.9 TDI 1.9 TDI 1.2; 1.4; 3.0 TDI 1.4 TDI 1.9 TFI
------------	--	---

CITROËN	Berlingo Jumper Jumpy Synergie Xantia Xsara	1.9 D 1.9 D; TD-FSO 1.9 D; 1.9 D/TD 1.9; 2.0 T 1.9; 2.0 D; TD; HDI 1.9; 2.0 D; TD; HDI
---------	--	---

FIAT	Ducato Ulysse	2.0 D 1.8; 2.0 Turbo
------	------------------	-------------------------

FORD Maioria dos Motores Diesel

PEUGEOT	205 305 306 309 405 406 605 806 Boxer Expert Partner	1.6; 1.8; 1.9 D 1.6; 1.8; 1.9 D 1.8; 1.9 D; TD 1.6; 1.9 D 1.6; 1.9 D 1.9 D 2.0 D; TD 1.9 D 1.9 D 1.9 D
---------	--	---

TALBOT	Express Horizon Solara	D D-J5D D
--------	------------------------------	-----------------

ISUZU	Motores Diesel	1.5; 1.7
-------	----------------	----------

OPEL	Motores Diesel Motores Gasolina	1.6; 1.7 1.2; 1.4; 1.6; 1.8; 2.0
------	------------------------------------	-------------------------------------

AI010041

100.00€

Kit comando de motores com 19 peças

Composição:

Marca	Modelo	Motorização
CITROËN	Synergie	2.0/Turbo; ZX 1.9D/TD
	Xantia	1.9D/TD
	Berlingo	1.9D
FIAT	Ulisses	2.0/Turbo
	Ducato	2.0
FORD	Fiesta	1.25; 1.4 (95-); 1.8-XR2i/RS1800 16V
	Mondeo	1.6; 1.8; 2.0 16V (93-)
	Escort/Orion	1.6; 1.8i 16V (92-)
HONDA	Accord/Prelude	2.3i (93-);
	Prelude	2.2 V-Tec; motor SOHC
	Accord	1.8, 2.0; 2.2 (-93); 2.0i (93-)
	Shuttle	2.2i;
	Civic	1.6 VTI
	Accord	(90-)
	Prelude	2.0 16V (-90)
LAND ROVER	Discovery MPi	2.0 16V (93-), motor 20T4
MAZDA	121	1.25
OPEL	Cavalier	2.5
	Calibra	2.5
	Vectra	2.5
	Omega	2.5; 3.0
	Sintra	3.0
	Astra	1.8; 2.0 16V
	Cavalier	2.0 16V
	Calibra	2.0 16V/Turbo
	Omega-B	1.6 16V
	Motor Gasolina OHC	1.2; 1.4; 1.6; 1.8; 2.0
	Motor Diesel OHC	1.6D i; 1.7D
	Motor Diesel OHC	
	Diesel Isuzu	1.5D i; 1.7D
	205; 305; 309; 405	1.6; 1.9
	405	1.8; 2.0 (92-)
	605	2.0
	Boxer	2.0
	205; 305	1.8; 1.9D
	306	1.8; 1.9D/TD
309	1.8; 1.9D; 1.8TD	
405	1.8TD; 1.9D	
406	1.9D	
Partner	1.9D	
Talbot/Horizon/Solara	1.9D	
J5/Talbot Express	1.9D	
605	1.9D/TD	
806	1.9TD	
Expert	1.9D	
Boxer	1.9D/TD	
RENAULT	R5	1.6D
	R9	1.6D
	411	1.6D
	Express/Extra	1.6D - motores Diesel F8M
	Clio; Express/Extra	
	R19	1.9D - motor diesel F8Q
	Espace	2.1D
	R21	2.1D
	R25	2.1D
	Trafic/Master	2.1D - motor Diesel J8S
	Clio	1.2; 1.4
	Express/Extra	R19 1.4
	Megane/Scenic	1.4; 1.6 - motor E7F/E7J
	R5	1.7
	Clio	1.7; 1.8
	R19	1.7
	R21	1.7
	Megane/Scenic	2.0
	Laguna	1.8; 2.0
	Trafic	1.7 - motor F3N; F3P; F2R
	Clio Williams; R19; Megane	2.0 16V - motor F7P; F7R;
	Laguna/Safrane	2.0 16V - motor N7Q/N7U
	ROVER	623
618/620		motor SOHC (93-)
216; 416		GTi 16V (-95) motor D16A9, motor K16 DOHC; motor SOHC 820 8V (m8)
		GTa/GTi 16V K16 (-95)
Metro		K16(89-)
214; 414		K16 (95-)
216; 416		K16 (95-)
MGF		1.8 MPI/VVC (95-)
220		M16 (-92)
220		Turbo T16 (92-)
420		M16 (-92)
420		T16 (92-)
320		Turbo M16 (-91)
620	Ti (94-)	
820	Turbo T16 Vitesse (91-)	
SAAB	900	2.5
	9000	3.0 V6
VW; AUDI; SEAT; SKODA		TDI desde 2000 ECOTEC 1.4; 1.6; 1.8; 2.0 16V



AI010060

59.00€

Jogo de 4 chaves para injetores 1/2"

Composição:

	Faces	Diâmetro (mm)	Medida (mm)
A	6	22	110
B	12	22	75
C	12	27	78
D	12	28	78



AI010060-A

16.30€

Chaves para injetores 1/2"

Faces: 6
Diâmetro: 22mm
Medida: 110mm



AI010060-B

13.70€

Chaves para injetores 1/2"

Faces: 12
Diâmetro: 22mm
Medida: 75mm



AI010060-C

13.00€

Chaves para injetores 1/2"

Faces: 12
Diâmetro: 27mm
Medida: 78mm



AI010060-D

13.00€

Chaves para injetores 1/2"

Faces: 12
Diâmetro: 28mm
Medida: 78mm



AI010063A

49.00€

Medidor de tensão de correias



AI010086

120.00€

Jogo de 12 chaves para terminais



AI010092
67.00€
Bloqueador do volante do motor

AI010104
32.70€
Ferramenta para retirar a tampa do depósito de combustível

Ajustável entre 122-199mm

AI010127
4.50€
Chave de remoção da correia trapezoidal

Aplicação: VOLVO e grupo VAG

AI010137
39.00€
Organizador para peças desmontadas

AI010166
8.00€
Chave torx para polie alternador 1/2"

Medida: T50

Comprimento: 110mm

AI010167
8.10€
Chave XZN para polie alternador 1/2"

Medida: M10

Comprimento: 110mm

AI010176
38.50€
Chave de remoção do filtro de combustível

Esta ferramenta torna a tarefa rápida e fácil de executar reduzindo os riscos de danificar o alojamento plástico do filtro.

Composição:

Marca	Modelo	Aplicação
CHEVROLET	Captiva, Epica	2.0 VCDi
CITROËN	Hdi Relay	2.0; 2.2; 2.8; 3.0
FIAT	500; Doblo; Strada;	1.3 JTD
	Idea; Panda; Punto	
	Idea; Multipla; Punto;	1.9 JTD
	Sedici (+2.0 JTD)	
	Ducato	2.0; 2.2; 2.3; 2.8; 3.0 JTD
LANCIA	Musa; Ypsilon	1.3 MJTD
OPEL	Agila; Astra; Corsa;	1.3 CDTi
	Combo; Meriva; Tigra	
	Astra; Signum; Vectra;	1.9 CDTi
	Zafira	
PEUGEOT	Boxer	2.0; 2.2; 2.8; 3.0 HDI
SAAB	9-3	1.9 TiD
SUZUKI	Splash; Swift; SX4	1.3 DDiS

AI010195
96.00€
Chave tensionadora de correias com 10 peças

AI020015
19.90€
Grampo para válvulas

Capacidade: 60-120mm

Altura: 150mm

AI0200
Grampo para segmentos

Ref. Capacidade (mm)

Preço

AI020019	115-180	24.00€
AI020020	70-108	20.40€
AI020021	50-100	18.90€

AI020024
71.00€
Grampo para válvulas

Para motores grandes/ diesel

AI020025
59.70€
Grampo para válvulas

Capacidade: 55-175mm

AI020027
29.60€
Desmonta válvulas universal com gancho

Compressor molas de válvulas

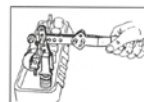
AI020048
Grampo para segmentos

Ref.	Capacidade (mm)	Altura (mm)	Preço
AI020048A	57-125	127	12.80€
AI020048D	90-175	100	14.20€
AI020048E	90-175	165	24.50€



AI020043

17.00€

Alicate para abraçadeiras de folios



AI020049

66.40€

Grupo universal para válvulas



AI020051

209.00€

Kit teste de compressão para motores a diesel

BMW, CITROËN, DACIA, DAF, DAIHATSU, FIAT, FORD, ISUZU, LAND ROVER, MAZDA, MERCEDES, MITSUBISHI; NISSAN, OPEL, PEUGEOT, RENAULT, ROVER, SEAT, TOYOTA, VOLKSWAGEN, VOLVO

Manómetro: 0-70bar

Diâmetro: 80mm

Turbo: 355mm

Adaptadores:

M10x1 (73,5mm); M10x1 (114,5mm);

M10x1 (119mm); M12x1,25 (54mm);

M14x1,25 (72mm) e M20x1,5 (78mm)

Simulador bocal 19 e 21mm



AI020052

130.50€

Kit teste de medição compressão do óleo em motores a gasolina

Inclui adaptadores e reparadores com rosca

Medidas: M10; M12; M14 e M18



AI020054

136.50€

Kit teste para a pressão do óleo

Inclui adaptadores e reparadores com rosca

Manómetro: 0-10bar/80mm

Turbo: 1 300mm

Jogo de 10 adaptadores



AI020056A

21.50€

Alicate para juntas de válvulas



AI020066

69.00€

Alicates cinta de segmentos

Abertura: 73-111mm



AI020092

73.00€

Extrator de parafusos danificados

Jogo de brocas/ extrator e guias para remoção de parafusos danificados

Gama: 5 a 16mm



AI020101A

113.00€

Dispositivo para teste de injetores common rail diesel

Este dispositivo permite medir rápida e eficientemente a quantidade de combustível de retorno de cada injetor, permitindo assim verificar se existe alguma anomalia. Medição até 6 injetores em simultâneo.

Inclui adaptadores para injetores Bosch, Delphi, Denso e Siemens.



AI020101A-A

44.00€

Jogo de copos de substituição para AI020101A



AI020103

61.00€

Extrator de inércia para desmontagem de injetores

Feito de aço endurecido de alta qualidade.

Desmontagem rápida e fácil de injetores presos em motores a diesel.

Preparado para rosca M8; M12 e M14



AI020107
147.50€
Ferramenta de ajuste do ponto de injeção

Permite efetuar o ajuste do ponto de injeção em motores diesel com bomba injetora convencional.

Aplicável entre outros em veículos ALFA ROMEO, AUDI, BMW, FIAT, FORD, ISUZU, IVECO, LANCIA, LAND ROVER, MITSUBISHI, NISSAN, RENAULT, ROVER E VOLKSWAGEN.

AI020109
67.00€
Jogo de 6 chaves para velas de incandescência

Composição/ medidas (mm):

 Chaves: 8; 9; 10; 12; 14 e 16
 Comprimento: 160mm

AI020131
110.00€
Compressor de molas de válvulas

AI020142
339.00€
Jogo de saca rolamentos pequenos

Composição/ medidas (mm):

 Saca
 Barra
 Expansores: 6 a 8; 8 a 10; 12 a 15 e 15 a 18

AI020162
18.90€
Alicate de pontas direitas para remoção de relays

AI020163
19.50€
Alicate de pontas angulares para remoção de relays

AI020178
295.00€
Kit remoção de velas de incandescência danificadas

AI020180
112.50€
Teste de sistemas turbo

Este kit pela insuflação de ar comprimido de baixa pressão no sistema do turbo, permite a verificação de fugas.

Composição: 4 pares de adaptadores

Ø	Medida (mm)
55-60	64
65-70	74
75-80	84
85-90	94

AI020184
13.50€
Chave para injetores MERCEDES BENZ

 Quadra: 1/2"
 Medida: 17mm
 Comprimento: 119mm

AI020184A
13.50€
Chave para injetores BMW e Volkswagen

 Quadra: 1/2"
 Medida: 14mm
 Comprimento: 119mm

AI020184B
14.00€
Chave para injetores MERCEDES BENZ

 Quadra: 1/2"
 Medida: 19mm
 Comprimento: 119mm

AI020184S
37.50€
Jogo de 3 chaves 1/2" para linha de injeção

Composição:

Ref.	Medida (mm)	Aplicação
AI020184A	14	BMW; VW
AI0200184	17	Mercedes 100, 130, 314, 360, 360h, 352A, 346/355, 401, 402, 403, 407h, 615, 616 e 617
AI0200184B	19	Mercedes 314, 352, A, 346/355, A, 401, 402/422, LA, 403, 407



AI020185 16.00€

Chave luneta aberta dobrada

Chave especial para desmontar tubos de alta pressão do sistema de combustível em motores a diesel

Medidas: 17x17mm



AI020201 62.00€

Jogo de 6 chaves de caixa com luneta aberta

Especialmente concebidas para trabalhar em espaços apertados e de difícil acesso.

Quadra: 1/2"

Comprimento: 100mm

Medidas: 12; 14; 16; 17; 18 e 19mm



AI020205 113.00€

Saca para injetores (diesel/ gasolina)

Saca especialmente concebido para a remoção de injetores Diesel e Gasolina. As garras são intermutáveis o que permite abranger um maior número de tipos de injetores.



AI030007 17.00€

Jogo de 5 peças para raspar, limpar e tirar juntas



AI050043S 19.90€

Jogo de 3 raspadores

Medidas: 15; 20 e 30mm



AI030010 3.70€

Ferramenta para rodar válvulas grandes



AI030011 3.50€

Ferramenta para rodar válvulas pequenas



AI030020 17.00€

Estetoscópio de mecânico



AI030025 5.90€

Jogo de riscador/ tira o-rings e juntas



AI030027 38.50€

Jogo de 6 riscadores com punho



AI040007 11.20€

Alicate para segmentos

Medidas: 1,2 a 6,3mm



AI040008 85.50€

Kit completo para teste de vácuo e sangrar travões



AI040031 116.00€

Bomba para vácuo e pressão com kit sangrador travões

Selecionar a válvula de controlo para a função de vácuo ou pressão.



AI040005
16.00€

Alicate de pontas curvas para anéis de segurança

AI040006
16.00€

Alicate de pontas direitas para anéis de segurança

AI040011
13.80€

Alicate para velas com pontas isoladas

AI040017
50.00€

Jogo de alicates de freios de cabeças recambiáveis

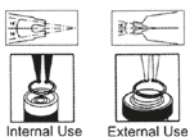
AI040018
18.20€

Alicate para abraçadeiras

AI010201
85.00€

Chave flexível para tubos de combustível

Permite trabalhar em locais com pouco espaço.

AI040060
25.50€

Alicate para tubos de combustível

Alicate para ligações rápidas de tubos de combustível.

AI040246
39.00€

Jogo para desligar tubos de combustível

Composição:

- 1 Chave direita para tubos 11,8mm
- 1 Chave direita para tubos 16mm
- 1 Chave angular para tubos 11,8mm
- 1 Chave angular para tubos 16mm

AI030002
26.00€

Jogo de 11 chaves para bujões óleo

Quadra: 3/4"

Utilização: chave de caixa 19mm

Hexagonais

8mm: BMW/ FORD/ GM

9mm: GM

10mm: FORD

12mm: FIAT/ LANCIA/ PEUGEOT/

14mm: LANCIA/ MERCEDES

17mm: AUDI/ BMW/ DAC

Quadradas + cabo

8mm: PSA/ RENAULT/ VOLVO

9,5mm: HONDA/ MAZDA/ PEUGEOT/ SAAB/ VOLVO

11mm: FORD

13mm: NISSAN/ SUBARU



AI050004

46.00€

Jogo de 15 peças de copo para filtros

Composição:

Faces	Medidas (mm)	Aplicação
14	65	GM, DAIHATSU, TOYOTA
14	65-67	DAIHATSU
14	68	MAZDA, FORD ESCORT, SUBARU
14	73	TOYOTA, LEXUS
15	74-76	SATURN
15	75-77	VW, AUDI, FORD, ISUZU, MERCEDES, OPEL
14	76	VW, PORSCHE, MERCEDES, BMW, AUDI A3, OPEL
30	76	FORD
15	80	NISSAN, HONDA, MAZDA, ISUZU, SUBARU, OPEL, TOYOTA
15	80-82	MAZDA, SUBARU, TOYOTA, HONDA, ACURA, NISSAN
15	90	HONDA ACCORD, MITSUBISHI, ISUZU
15	93	OPEL, MAZDA, VOLVO, MITSUBISHI, NISSAN, VW, PORSCHE, RENAULT, FORD, HONDA, AUDI
36	93	FORD
15	100	ISUZU, MITSUBISHI

Adaptador 1/2" (F)x3/8"(M)



HC

Chaves de copo para filtros

Ref.	Faces (mm)	Medida (mm)	Preço
HC-78/15	15	78	4.60€
HC-65/67	14	65-67	4.20€
HC-65/14	14	65	4.40€
HC-68/14	14	68	4.10€
HC-74/15	15	74	4.30€
HC-66/6	6	66	4.10€
HC-76/8	8	76	4.60€
HC-73/14	14	73	4.30€
HC-74/76	15	74-76	4.50€
HC-75/77	15	75-77	4.50€
HC-76/12	12	76	4.50€
HC-76/30	30	76	4.60€
HC-93/36	36	93	4.60€
HC-76/14	14	76	4.60€
HC-108/15	15	108	4.40€
HC-108/18	18	108	4.40€
HC-65103		65-120	14.30€
HC-106/15	15	106	4.60€
HC-100/15	15	100	4.50€
HC-86/16	16	86	4.50€
HC-90/15	15	90	4.60€
HC-80/82	15	80-82	4.60€
HC-92/10	10	92	4.60€
HC-93/45	45	93	4.60€
HC-93/15	15	93	4.60€
HC-86/18	18	86	4.60€
HC-80/15	15	80	4.60€
HC-96/18	18	96	4.60€
HC-95/15	15	95	4.60€
HC-9.5mm	adaptadores 1/2"-3/8"		1.75€

AI050004A

113.00€

Jogo de 30 peças de copo para filtros

Composição:

Faces	Medida (mm)	Aplicação
14	65	GM, DAIHATSU, TOYOTA
14	65-67	DAIHATSU
14	68	MAZDA, FORD ESCORT, SUBARU
14	73	TOYOTA, LEXUS
15	74	AUDI, GM, ROVER, CHRYSLER
15	74-76	SATURN
15	75-77	VW, AUDI, FORD, ISUZU, MERCEDES, OPEL
8	76	FIAT MAREA, LANCIA DELTA
12	76	FIAT (DUCATO, SCUDO, ULYSSE), RENAULT (MEGANE, LAGUNA, ESPACE)
14	76	VW, PORSCHE, MERCEDES, BMW, AUDI A3, OPEL
30	76	FORD
15	78	NISSAN, FORD, TOYOTA
15	80	NISSAN, HONDA, MAZDA, ISUZU, SUBARU, OPEL, TOYOTA
15	80-82	MAZDA, SUBARU, TOYOTA, HONDA, ACURA, NISSAN
16	86	Volvo (S40, S60, S70, S80)
18	86	VW (GOLF TDI, PASSAT/TDI), AUDI A6 TDI, RENAULT (CLIO, RAPID 1.9D, LAGUNA, SAFRANE, ESPACE 2.1D, CITROEN; PEUGEOT
15	90	HONDA ACCORD, MITSUBISHI, ISUZU
10	92	FIAT (CINQUECENTO, COUPE, CROMA, PANDA, REGATA, RITMO, SEICENTO, TEMPRA, TIPO), LANCIA (BETA, DEDRA, KAPPA, THEMA)
15	93	OPEL, MAZDA, VOLVO, MITSUBISHI, NISSAN, VW, PORSCHE, RENAULT, FORD, HONDA, AUDI
36	93	FORD
45	93	VW AUDI (2.4; 2.6; 2.8L)
15	95	TOYOTA, ALFA, GM, FORD, CHRYSLER
18	96	AUDI (A4, A6TDI), VW (PASSAT 97 TDI), RENAULT (LAGUNA 2.2D, SAFRANE 2.2D, ESPACE 2.2D, R19, RAPID, MEGANE 1.9/2.1D)
15	100	ISUZU, MITSUBISHI
15	106	FIAT DUCATO 2.5 TD
18	108	RENAULT (ESPACE, LAGUNA,
15	108	MASTER, SAFRANE, TRAFFIC 2.4; 2.5; 2.8D)

Chave filtro de óleo ajustável 65-120
Adaptador 1/2"(F)x3/8"(M)

AI050009A

8.00€

Chave de filtros



AI050022

9.90€

Chave de filtros

Ajustável: 60-90mm



AI050024

20.50€

Jogo de 4 alavancas

Medidas: 200; 330; 540 e 600mm



AI050001

14.50€

Chave de filtros de 3 pernas

Capacidade: 60-120mm



AI050037

16.90€

Chave de filtros de 3 pernas

Capacidade: 45-110mm



AI030067

35.50€

Jogo de 17 chaves para bujões de óleo 3/8"

Composição:

6 Chaves hexagonais: 8; 9; 10; 11; 12; 13 e 14mm

9 Chaves quadradas: 7; 8; 10; 11; 12; 13 e 14mm 5/16" e 3/8"

1 Chave quadrada (fêmea): 10mm

1 Chave triangular



AI050040

8.50€

Chave para bujões

Medidas: 8 e 10mm



AN010009A

6.80€

Chave para bujões de carter

Medidas (mm): 10; 11; 12; 13; 14; 15 e 17mm

Comprimento: 150mm



AN010030

12.10€

Alicate para remoção de pesos de rodas



AI050042

15.30€

Chave para remoção de ventoinha

Medidas: 8 e 10 mm

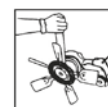

AI050043

18.00€

Alicate de pressão para filtros de óleo

Medida: 53-118mm



AI050076

53.00€

Chave de filtros ajustável 1/2"

Medida: 60-80mm



AI050077

16.50€

Chave de filtros de cinta

Medida: 25-160mm



AI050080

8.50€

Chave para parafusos cabeça do motor 1/2"

Medida: M9

Comprimento: 100mm



AI05009

Chave de velas longa 3/8"

Ref.	Medida (mm)	Compr. (mm)	Preço
AI050092	14	250	13.00€
AI050093	16	250	14.50€



AI050096S

53.00€

Jogo de 7 chaves especiais

Sensores de vácuo e de oxigénio
Válvulas pressostáticas



AI050102

68.50€

Chave de filtros 3 pernas auto ajustáveis

Capacidade: 95-165mm



AI050202

9.50€

Chave de copo para filtros de 14 faces 3/8" com 54mm

Marca	Modelo	Motorização
TOYOTA	Auris/ Corolla/ Prius	1.8/ 2.0 4 cilindros



AI010033

6.70€

Chave para sensor de oxigénio



AI050104

17.90€

Chave para sensor de oxigénio

Medida: 22mm



AI050109

43.50€

Chave de filtros de corrente

Comprimento: 350mm
Filtros: 60 a 105mm



AI050113

170.00€

Jogo de bits impacto de 3/4" e 1"

Composição/ medidas (mm):
5 Chaves torx T60, T70, T80, T90 e T100 (107mm)
4 Chaves hexagonais 17, 19, 22 e 24mm (107mm)
4 Chaves torx E18, E20, E22 e E24 (107mm)
1 Chave sextavada 3/4" 22mm
1 Chave sextavada 1" 22mm
1 Chave hexagonal em L 4mm



AI050152

16.50€

Tubo para descarga de óleo usado do alojamento do filtro



AI050152A

10.50€

Tubo para descarga de óleo usado do alojamento do filtro

Aplicação: TOYOTA e LEXUS



AI050176

170.00€

Kit para montagem de correias estriadas com 11 peças

Composição:

Marca	Modelo
AUDI	A3
BMW	118/ 120/ 318/ 325/ 330/ 335/ 520/ 525/ 530/ 535/ 635/ 720/ 730/ X3/ X5
CITROËN	C2/ C3/ C4/ Jumper/ Relay
CHRYSLER	Grand Voyager/ Voyager
FIAT	Albea/ Doblo/ Ducato/ Fiorino/ Marea/ Multipla/ Qubo/ Linea/ Palio/ Siena/ Stilo e Strada
FORD	C-Max/ Courier/ Fiesta/ Focus C-Max/ Fusion/ Mondeo/ Tourneo/ Transit
IVECO	Daily
LANCIA	Lybra
MAZDA	2/ 3/ 5/ Axela
MERCEDES	Sprinter/ Viano/ Vito
MITSUBISHI	ASX
PEUGEOT	206/ 207/ 307/ Boxer
SEAT	Altea/ Ibiza
SKODA	Octavia/ Yeti
VOLKSWAGEN	EOS/ Golf/ Passat/ Polo/ Sirocco
VOLVO	C30/ S40/ V50



AL010093
29.00€

Ferramenta para montagem/ desmontagem de correias elásticas poli-v

AI050191
11.00€

Chave magnética para bujões

AI050192
33.00€

Funil universal para óleo

Grampo de fixação ajustável: 28-74mm

AI060006
6.90€

Reparador "rosca" alojamento de velas

Medida: 14mm

AI060020
3.60€

Apalpa folgas com 20 lâminas

Medidas (mm): 0,05; 0,10; 0,15; 0,20; 0,25; 0,30; 0,35; 0,40; 0,45; 0,50; 0,55; 0,60; 0,65; 0,70; 0,75; 0,80; 0,85; 0,90; 0,95 e 1

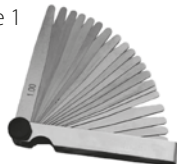
AI060030
165.00€

Kit de reparação de rosca de alojamento de velas com 56 peças

Mecânica
AI060030

Helicoïdes

Ref.	Medida	Quadra	Quantid.	Preço
AI060030-A	M10x1,0	3/8	10	6.30€
AI060030-B	M12x1,25	3/4	10	12.40€
AI060030-C	M14x1,25	7/16	10	15.50€

AI060030

Punção

Ref.	Medida	Quantid.	Preço
AI060030-D	M10x1,0	1	10.40€
AI060030-E	M12x1,25	1	13.40€
AI060030-F	M14x1,25	1	19.40€

AI060031
120.00€

Kit reparador de rosca com 87 peças

 Composição: Medidas:
 Helicoïdes: 25x M6x1.0x1.5 (9mm)
 25x M8x1.25x1.5 (12mm)
 25x M10x1,5x1,5 (15mm)

 Macho: M6x1.0
 M8x1.25
 M10x1.5

 Punção: M6x1.0
 M8x1.25
 M10x1.5

 Broca: 6,3mm
 8,3mm
 10,4mm

 Punho: M6x1.0
 M8x1.25
 M10x1.5

AI060031

Helicoïdes

Ref.	Medida	Quantid.	Preço
AI060031-A	M6x1,0	10	4.60€
AI060031-B	M8x1,25	10	5.70€
AI060031-C	M10x1,5	10	7.60€

AI060031

Punção

Ref.	Medida	Quantid.	Preço
AI060031-D	M6x1,0	1	6.40€
AI060031-E	M8x1,25	1	8.60€

AI060031

Broca

Ref.	Medida (mm)	Quantid.	Preço
AI060031-G	6,6	1	4.40€
AI060031-H	8,3	1	7.70€
AI060031-J	10,4	1	11.00€



AL010006

27.30€

Jogo de 3 alicates

Para ligações rápidas de tubos de combustível



AL010011

19.50€

Chave para fêmeas suspensão

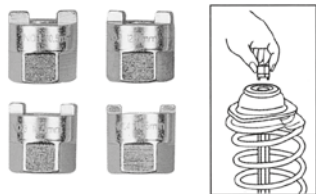

AN010001

43.50€

Kit de ferramenta para travões com 11 peças

Para recuar e rodar êmbolos dos travões



AN010001C

58.00€

Kit de ferramenta para travões com 18 peças

Para recuar e rodar êmbolos dos travões



AN010001D

157.00€

Kit de ferramenta para travões

Para recuar e rodar êmbolos dos travões



AN010293

31.00€

Chave especial para pressionar as pinças de travão



AN010033

4.40€

Removedor do interior de válvulas



AN010085A

13.20€

Ferramenta para colocar válvulas de pneus



AN010038

7.10€

Extrator de vedantes



AN010049

11.00€

Centrador de embraiagens



AN010063

55.90€

Alicate para freios de travão



AN010065

56.80€

Jogo de 4 pinças para cilindros de travão



AN010081A

22.50€

Alicate de molas de travões



AN010066

41.30€

Kit de desmontagem de embraiagem do compressor A/C

Aplicável em várias marcas de compressores A/C



AN010054A

21.00€

Jogo de 3 alicates para oclusão de tubos



AN010054N

19.90€

Alicate de pressão para tubos



AR060062

32.50€

Alicate tensor para abraçadeiras de tubos

Amplitude: 5 a 55mm



AN010068

5.50€

Limpa bornes e terminais de bateria



AN010072

28.00€

Reparador de rosca interno e externo

Medidas das rosca: 0,8; 1; 1,25; 1,50; 1,75; 2 e 3mm



AN010072C

16.50€

Reparador de rosca SAE (polegadas)

Medidas das rosca: 9"; 10"; 16"; 20"; 27"; 28" e 32"



AN010091A

83.00€

Removedor da barra de direção



AN010092

49.00€

Chave excêntrica para direções/ barras

Medida: 33-42mm



AN010106A

43.50€

Corta tubos de escape

Não utilizável em tubos de aço inox

Medidas: 19 a 76mm de diâmetro



AN010112

18.00€

Adaptador para saca de semieixo



AN010131

16.00€

Rolete calcador



AN010137

70.00€

Alicate para cubos de rodas



AN010186B

540.00€

Kit para embraiagens auto ajustáveis



AN010188

Ferro desmonta pneus



Ref.	Medida (mm)	Preço
AN010188A	500	19.50€
AN010188C	200	4.00€

AN010225

520.00€

Ferramenta para instalar/ remover rolamento manga eixo
Permite rapidez, segurança e profissionalismo sem esforço na tarefa
Aplicação: PEUGEOT, CITROËN e RENAULT



AN010226

15.30€

Medidor de espessura dos discos de travão e profundidade do piso dos pneus

Discos de travão: 0-60mm
Material: alumínio

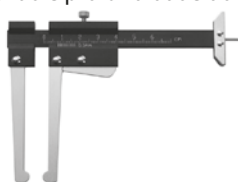

AG010205

18.90€

Medidor digital de profundidade

Utilizado para medir a profundidade do piso dos pneus e das pastilhas de travões.

Especificações:

Gama de medição: 0-25,4mm

Resolução: 0,01mm

Display: LCD

Medição em milímetros ou polegadas.

Utiliza pilhas SR44/ LR44 de 1,4V (não incluídas).



AN010272

13.30€

Alicate para tampas plásticas fêmea da roda

Permite retirar as tampas plásticas das fêmeas da roda sem danificar as jantes.



AN010279

325.00€

Mecanismo para desbloqueio de roda MB/ BMW

Aplicação

Mercedes Benz: W164 (Classe GL); W197 (SLS); W204 (Classe C); W212 (Classe E); W221 (Classe S) e W251 (CLR)

BMW: F01/F02 (Série 7); F07/F10 (Série 5);

F12/F13 (Série 6); F25 (x3) e

F30/ F31/ F32/ F33/ F34 (Séries 3 e 4)



AN020006

8.10€

Chave para molas dos calços de travão



AN020007

27.50€

Despolidor de cilindros

Medida: 51-177mm



AN020007-1

11.50€

Jogo de 3 pedras para despolidor de cilindros

Aplicável ao despolidor AN020007

AN020022

27.50€

Jogo de despolidor de cilindros

Composição/ medidas (mm):

Medida: 18-89

Pedras: 19; 28,8 e 51

Jogo de pedras de substituição



AN020022
Jogo de pedras para despolidor de cilindros

Ref.	Medida (mm)	Unidades	Preço
AN020022-A	51	3	7.60€
AN020022-B	28,8	3	5.80€
AN020022-C	19	3	5.20€
AN020022-D	28,8	2	5.00€

AN040035A
Corta tubos
15.00€

AN040043A
Jogo de cortar tubos e abocardador

Composição/ medidas (mm):

Fixador de tubos: 4; 6; 8; 10; 12; 15 e 16

Punções abocardador: 4; 6; 8; 10 e 12

52.00€

AN040082
Jogo de extrator de fêmeas danificadas com 9 peças 3/8"

Medidas: 10; 11; 12; 13; 14; 15; 16; 17 e 19

112.00€

AN040101
Bit 1/2" pentagonal para freios travões
6.90€

AN040168
Jogo de ferramenta para instalar/ remover rolamentos de roda
 Permite rapidez, segurança e profissionalismo sem esforço na tarefa

Para rolamentos: 60 a 85mm

360.00€

AR020018
Teste de compressão

Tubo flexível com adaptador: 14 e 18mm

 Escalas: 0-300psi; 21kg/cm²; 21bar e 2 100kpa

19.90€

AR020019
Teste de vácuo e bomba combustível
21.40€

AR020053A
Kit de acessórios eletricista/ eletrónica auto
215.00€

AR030013
Densímetro para líquido de baterias
3.80€

AR030034
Auto tester circuitos entre 3-48V

Indicação da polaridade por Leds

5.60€

AR030041
Jogo de 7 aplicadores de o-rings

Composição/ medidas (mm):

14,4-16; 15,9-17,5; 17,5-19,1; 20,7-22,4;

24-26; 25,5-27,5 e 30,3-32,3

58.70€

AR030047

23.50€

Teste fluido de travões
Bateria não incluída.



AR030062

36.00€

Teste de atuadores
Este aparelho permite o teste a componentes eletrónicos que atuam por campos magnéticos e eletromagnéticos.



AR040043

15.10€

Saca terminais de cabo de bateria e limpa parabrisas



AR040016

78.00€

Jogo de cabos de arranque de bateria 500 Amp
Dimensões: 0.3x268x12mm
Comprimento: 3 600mm



AR060002A

19.70€

Alicate para abraçadeiras - matriz "+"



AR060003

14.20€

Alicate para abraçadeiras - matriz "V"



AR060008

15.30€

Alicate para abraçadeiras de filtros de combustível e tubos de vácuo



AR060011

10.20€

Dispositivo para bloquear tubos



AR060020

12.00€

Alicate para remover tubos



AR060021

41.20€

Alicate para abraçadeiras



AR060024A

157.00€

Kit de 7 alicates para abraçadeiras



AN010177B

55.00€

Alicate especial para abraçadeiras de fole



AR060029

48.00€

Alargador de foles



AR060032

15.80€

Kit de adaptadores para desencaixe de tubos A/C



AR060043

101.00€

Jogo de 52 peças para remoção de rádios

Aplicação:

Marca Auto: AUDI; BMW; FIAT; FORD; SKODA; MERCEDES; OPEL; PORSCHE e VOLKSWAGEN
 Marca Rádio: Becker; Blaupunkt; Clarion; JVC; Grundig; Kenwood; Panasonic; Pioneer e Sony



Ferramenta - aplicação especial por MARCAS GRUPO BMW e MINI

AI010121

57.00€

Chave para boia do depósito de combustível

Aplicação: AUDI, BMW, MERCEDES, PORSCHE e VOLKSWAGEN

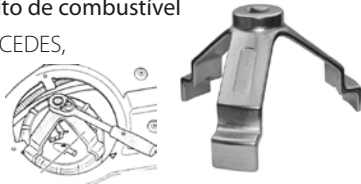

AI010139

105.00€

Ferramenta para desmontagem do sensor do nível de combustível

Aplicação: BMW e MINI

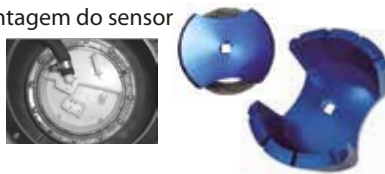

AL010099

233.00€

Kit comando de motor diesel BMW

Modelo	Motorização
E34/ E36/ E38/ E39/ E46/	M41/ M51/ M47TU/ M47T2/
E53/ E60/ E61/ E63/ E65/	M57TU/ M57T2
E66/ E70/ E83/ E87/ E90/ E91/	
Land Rover	2.5DT/ 3.0TD6/
Freelander	2.0TD4



AR060055

23.00€

Alicate de abraçadeiras de tubos

Abertura de 22 a 55mm



AL010128

50.00€

Kit comando de motor BMW

Modelo	Motorização	Ano
118d	E87	2003-2007
120d	E87	2003-2007
318d/td	E46 E90/91	2000-2008
320d/crd	E46 E90/91	1997-2008
325d	E90/91/92/93	2006-2010
330d/xd/crd	E46 E90/91/92/93	1998-2008
510d	E39 E60/61	1999-2010
525d/xd	E39 E60/61	1999-2010
530d/xd	E39 E60/61	1998-2010
535d	E60/61	2004-2010
635d	E63/64	2004-2010
730d	E38 E65/66	2003-2010
X3 2,0d	E83	2003-2007
X3 3,0d	E83	2003-2010
X5		



AI010115

25.00€

Saca bombas injetoras BMW

Modelo	Motorização
318D/ 320D/TD/ 330D	E46
525D/ 530D	E39
525D/ 530D/ 535D	E60/E61
730D	E38
X5 3,0D	E53



AI020184A

13.50€

Chave para injetores BMW e Volkswagen

Quadra: 1/2"
 Medida: 14mm
 Comprimento: 119mm



AI050071S

299.00€

Jogo de 8 chaves especiais BMW

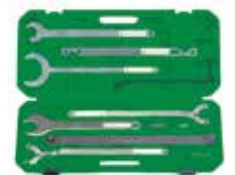

**Ferramenta - aplicação especial por MARCAS
FIAT e OPEL**

AL010044

149.00€

Kit comando de motor FIAT/ OPEL

Marca	Modelo	Motorização	Ano	Peças nº
FIAT	Panda/ Idea/ Doblo	1.3JTD Multijet 1.7D/ 1.9D/ TD/ JTD2.4 1.9/ 2.4JTD 16V/ 20V	2004-2007	7; 8; 9; 10 1; 3; 4 2; 3; 4; 5; 6; 7 7; 8; 9; 10
OPEL	Agila/ Corsa/ Astra H/ Tigra B/ Meriva/ Astra/ Vectra/ Signum/ Zafira	1.3CDTI 1.9CDTI	2004-2007 2004-2006	2; 3; 4; 5; 6; 7
ALFA ROMEO	147/ 156	1.9JTD 16V/ 2.4JTD 20V		2; 3; 4; 5; 6; 7



AL010196

47.00€

Kit comando de motor gasolina

Marca	Modelo	Motorização
ALFA ROMEO	159	939A4.000
CHEVROLET	Aveo/ Cruze/ Orlando	
FIAT	Croma	939A4.000
OPEL	Astra G/ Astra H/ Corsa D/ Meriva A/ Zafira B/C/ Vectra C/ Signum/ Insignia	Z16LEL/ Z16LER/ Z16LET/ Z16ZE1/ Z16XEP/ Z16ZER/ LLu/ A16LET/ A16XEL/ 2HO/A18XEL/ 2HO/A18XE R/Z18XER

**Ferramenta - aplicação especial por MARCAS
FORD, MAZDA e VOLVO**

AL010070

22.00€

Kit comando motor FORD/ PEUGEOT/ CITROËN

Marca	Modelo	Motorização:
FORD	Fiesta/ Fusion Focus/ Focus C-Max Fusion/ Fiesta	1.4TDCI 1.6TDCI 1.6TDCI
CITROËN	C4	1.6HDI
PEUGEOT	206	1.4HDI
PEUGEOT	307	HDI



AL010071

73.00€

Kit comando motor FORD

Modelo	Motorização	Ano
Fiesta	1.8D Turbo	
Focus		
Focus C-Max	1.8TDCI	
Tourneo Connect	1.8TDDI/ TDCI	
Transit Connect	1.8TDDI/ TDCI	2002-2006



AL010107

68.00€

Kit comando motor FORD

Modelo	Motorização em diesel
Fiesta	1.8TDDI/ TDCI
Focus	Turbo
Transit	
Transit Connect	



AL010175

29.00€

Pino de fixação árvore de cames

Marca	Modelo	Motorização	Ano
FORD	Fiesta/ Fusion Focus C-Max Mondeo Transit	1.4TDCI 1.4/ 1.6TDCI 2.0TDI/ TDCI/ 2.2TDCI 2.0TDI/ TDCI/ 2.4TDI/ TDCI	2002>2009
VOLVO	S40/ V50	1.6D/ 1.9D	



**Ferramenta - aplicação especial por MARCAS
FORD, MAZDA e VOLVO**
AL010205
7.70€
Kit comando motor FORD/ MAZDA/ VOLVO

Marca	Modelo	Motorização
FORD	C-Max/ Cougar/ Fiesta/ Focus	HWDA/ HWDB/ CSDA/ QQDA/ QQDB/ QQDC/ AODA/ AODB/ DBA/C/ EDBB/ EDBD/ F8JA/ F8JB/ FUJA/ FUJB/ M7JA/ M7JB/ FXJA/ FX JB/ FYJA/ FYJB/ N4JB/ FHA/ FHE/ L1T/ L1V/ ASDA/ ASDB/ FXDA/C/ FXDB/D/ FYDA/C/ FYDB/D/ EYDB
MAZDA	6	
VOLVO	C-30/ S40/ S80/ V50/ V70	B4164S3/ B4184S11/ B4204S3

AL010218
135.00€
Kit comando motor FORD
Modelo:

Fiesta/ Fusion/ Focus/ C-Max/ B-Max/ S-Max/ Mondeo/ Galaxy

AN040286
315.00€
Extrator de sinoblocos

Marca	Modelo	Ano
FORD	Focus I	1998-2005
	Focus II	2004-2008
	CB4	2008-2011
MAZDA	3	2003-2008
	3	2009 ->
	5	2005-2010

**Ferramenta - aplicação especial por MARCAS
HYUNDAI e KIA**
AL010282
60.00€
Kit comando motor HYUNDAI/ KIA
Aplicação:

HYUNDAI: Accent; Elantra; Getz; i10; i20; i30; i40; ix35; ix55; Matrix e Tucson.

KIA: Carens; Cee'd; Cerato; Optima; Picanto; Pro-Cee'd; Rio; Soul; Sportage e Venga.

**Ferramenta - aplicação especial por MARCAS
MERCEDES**
AG010204
9.00€
Chave de impacto para rodas especial - MERCEDES 1/2" com 17mm
Aplicação:

MERCEDES: W204 (Classe C); W204(GLK); W207/ W211/ W212 (Classe E); W166 (Classe M); W221/ W222 (Classe S); W172 (SLK); W164/ W166 (ML) e W216 (CL) e Maybach.

AI010114
28.50€
Jogo de ferramentas para airbag

AI010097
16.70€
Chave hexagonal 1/2" especial para SCANIA e MERCEDES
Comprimento: 27mm

AI010116
42.50€
Saca velas de incandescência
Motorização: 611/ 612/ 613
Comprimento: 10mm

Ferramenta - aplicação especial por MARCAS MERCEDES
AI020113
141.00€
Jogo saca injetores common rail MB

 Motorização:
OM 611/ OM 612/ OM 613

AI020184
13.50€
Chave para injetores MERCEDES BENZ

 Quadra: 1/2"
Medida: 17mm
Comprimento: 119mm

AI020184B
14.00€
Chave para injetores MERCEDES BENZ

 Quadra: 1/2"
Medida: 19mm
Comprimento: 119mm

AI020186
54.00€
Jogo saca bicos injetores

Modelo	Motorização
Classe C/ Classe E/ Sprinter	108CDI/ 110CDI 16V/ 112CDI 16V/ C220CDI 16V/ E200CDI 16V

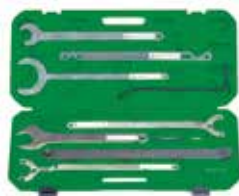
AI050071S
299.00€
Jogo de 8 chaves especiais MB

AI050085A
14.30€
Chave de filtros de 14 faces com 74mm

Nota: Se usar com uma chave caixa de 27mm, deve ser aplicada uma força máxima de 25Nm, caso sejam aplicadas forças superiores, corre-se o risco de danificar a chave filtros.

Marca:

 MERCEDES/AUDI A3/ BMW E36/ CITROËN/
FIAT/ FORD/ LANCIA/ MAZDA/ NISSAN/
OPEL/ PEUGEOT/ PORSCHE/ RENAULT/
TOYOTA/ VOLKSWAGEN Golf IV

AI050200
72.00€
Jogo de 4 varetas para óleo de transmissão

Aplicacion: Mercedes Benz

AL010057
128.00€
Chave bloqueadora de cambotas MB

AN040126
195.00€
Extrator de sinoblocos eixo traseiro MB

Ferramenta - aplicação especial por MARCAS GRUPO PSA - PEUGEOT/ CITROËN
AI010136
96.00€
Kit comando motor HPI (gasolina) e HDI (diesel) PEUGEOT/ CITROËN

Marca	Modelo	Motorização	Ano
PEUGEOT	206/ 307/ 406	1.8 16V	2000-2004
	607/ 806/ 807	2.0 16V	2002-2005
	Expert		
CITROËN	C4/ C5	1.8/ 2.0HPI	2002-2005
	Xsara	2.0 16V	2002-2005
	Xsara Picasso	1.8/ 2.0 16V	2002-2005
	Evasion/ C8 Jump		

Códigos motor: 6FZ (EW7J4)/ FRN (EW10J4/L4/5)/ RLZ (EW10D)

AL010175
29.00€
Pino de fixação árvore de cames

Marca	Modelo	Motorização
CITROËN	C1/ C2/ C3/ Xsara	1.4HDI
	C3/ C4	1.6HDI
PEUGEOT	107/ 206/ 207	HDI
	307	1.4/ 1.6HDI



**Ferramenta - aplicação especial por MARCAS
GRUPO PSA - PEUGEOT/ CITROËN**
AN040100
6.60€

Chave de caixa pentagonal para travões PSA

AL010041
147.00€

 Kit comando motor HPI (gasolina) e HDI (diesel) PEUGEOT/
CITROËN

Marca	Modelo	Motorização	Ano	
CITROËN Diesel	Visa/ BX/ ZX/ Xantia/ Xsara/ Synergie/ C15/ Berlingo/ Dispatch/ C25/ Relay	1.7/ 1.8/ 1.9/ D/ TD	1984-2002	
	Saxo/ AX/ Xsara	1.5D	1994-2007	
	Xsara/ Berlingo/ Dispatch 1.9D		1998-2007	
	Xsara/ Xsara Picasso/ Xantia/ C5/ Synergie/ Berlingo/ Dispatch/ Relay 2.0HDI		1998-2007	
	C4	2.0HDI	2004-2008	
	C5	2.2HDI	2000-2004	
	C8	2.0/ 2.2/ HDI	2002-2007	
	Relay	2.5D/ TurboD	1994-2002	
	XM/ Xantia/ Dispatch/ Synergie/ Evasion	2.1D/ 2.2D/ TD	1994-2002	
	CITROËN Gasolina	AX/ Xsara/ AX GTi/ Saxo/ ZX/ Berlingo	1.0/ 1.1/ 1.4/ 1.6	1994-2004
		C2/ C3/ C3 Pluriel/ Berlingo	1.0/ 1.1/ 1.4	2002-2007
		Saxo/ Xsara	1.6 16V	1997-2006
		C2/ C3 Pluriel/ C4	1.6	1997-2006
		Xsara/ Xantia	1.8 16V	2002-2008
		ZX/ Xsara	2.0 16V	1996-2000
		Synergie/ Evasion/ Relay/ Jumper	2.0 Turbo	1994-2002
Xsara		2.0 16V	2000-2004	
Xsara/ C5/ Xsara Picasso		2.0HPI/ 2.0 16V/ 1.8	1999-2002	
Xsara/ C5/ Xsara Picasso		2.0HPI/ 2.0 16V/ 1.8	2002-2008	
205/ 305/ 405/ Partner/ 306/ 309 Talbot Horizon/ Solara Express		1.8/ 1.9/ D/ TD	1982-2001	
206/ 307		1.4 HDi	2001-2008	
206/ 306/ Express/ Partner		1.9D	1998-2007	
206/ 306/ 307/ 406/ 806/ 807		2.0HDI/ 2.0HDI 16V	1997-2007	
307/ 307 CC/ 407		2.0HDI	2003-2008	
406/ 607		2.2HDI	2002-2007	
406/ 806/ Expert/ Boxer	1.9D/ TD	1994-2002		
406/ 605/ 806	2.1D Turbo	1994-2002		
PEUGEOT Gasolina	106/ 205/ 306/ 307/ 405/ Partner	1.0/ 1.1/ 1.4/ 1.6	1993-2008	
	206	1.1/ 1.4/ 1.6	1998-2008	
	205/ 309/ 306/ 405/ 806/ 605/ 406/ Partner/ Boxer	1.6/ 1.9/ 1.8/ 2.0	1989-2002	
	206/ 307	1.6 16V	2000-2008	
	306/ 407	1.8 16V	1999-2002	
	206/ 307/ 406/ 406 Coupe/ 607/ 806	2.0 16V	1998-2000	
	306/ 406	1.8 16V	1995-1998	
	306/ 406	2.0 16V	1994-2001	
	306/ 406	1.6/ 2.0 Turbo	1994-2001	
	406	1.8 16V	2000-2004	
	406/ 406 Coupe/ 607	2.2 16V	1998-2008	
	807	2.0 16V	2002-2005	

RENAULT, NISSAN e DACIA
AL010038
17.90€

Kit comando de motor RENAULT/ NISSAN

Marca	Modelo	Motorização
RENAULT	Modus/ Laguna/ Kangoo/ Clio	1.5dCI/ 1.9dCI
NISSAN	Almera/ Micra	1.5dCI

AL010190
48.00€

Kit comando de motor

Marca	Modelo	Motorização	Ano
RENAULT	Clio	1.2/ 1.4/ 1.6	
	Clio Sport	2.0	
	Espace	2.0	
	Scenic	1.4/ 1.6/ 1.8/ 2.0	
	Scenic II	1.4/ 1.6/ 2.0	
	Grand Scenic II	1.4/ 1.6	
	Laguna	1.8/ 2.0	
	Laguna II	2.0	
	Megane	1.4/ 1.6/ 1.8/ 2.0	
	Megane II	1.4/ 1.6/ 2.0	
DACIA	Logan	1.4/ 1.6	
	Sandero	1.4/ 1.6	
NISSAN	Micra		2003>2008
	Almera		2002>2006
	Note		2006>2008
	Qashqai		2007>2008
Diesel		1.2/ 1.4/ 1.6/ 1.8 (8v-16v)/ 2.0IDE/ 2.0Turbo	

Códigos motor: D4F/ K4J/ K4M/ K7M/ K9K/ F4P/ F3R/ F4R/ F5R/ F4RT



Ferramenta - aplicação especial por MARCAS GRUPO VAS - AUDI, VOLKSWAGEN, SKODA, SEAT e PORSCHE

AI010069 21.50€

Ferramenta de bloqueio da cambota VOLKSWAGEN

Para bloquear a cambota quando se quiser substituir a correia ou outros componentes.

Marca	Modelo	Motorização
AUDI	A4/ A6	
SEAT	Alhambra/ Altea/ Arosa/ Cordoba/ Ibiza/ Leon/ Toledo	
VOLKSWAGEN	Bora/ Golf/ Lupo/ Passat/ Polo	TDI's

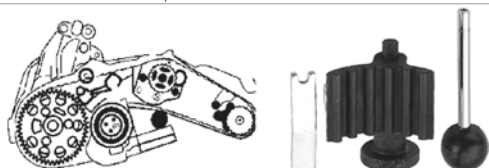

AI010070 26.50€

Ferramenta de bloqueio da cambota (VAS)

Marca	Modelo	Motorização
AUDI	A2	1.4TDI
	A3	1.9TDI/ 2.0TDI
	A4	1.6TDI/ 1.9TDI/ 2.0TDI
	A6	1.9TDI
SEAT	Altea	1.9SDI/ TDI
	Leon	1.9/ 2.0TDI
	Toledo	1.9SDI/ TDI
VOLKSWAGEN	Beetle/ Bora/ Sharan	1.9TDI
	Fox/ Lupo	1.4TDI
	Golf	1.9/ 2.0TDI
	Polo	1.4/ 1.9TDI



AI020127 40.50€

Ferramenta para tirar injetores

Aplicação: Grupo VAS (motores TDI)



AI020154 235.00€

Instalador vedante da cambota VOLKSWAGEN

Marca	Modelo	Ano
AUDI	A3	2004>
	A4	
SKODA	Octavia2/ Roomster/ Fabia	
VOLKSWAGEN	Golf	2004>
	Transporter T5/ Caddy/ Touran	2004>



AI020184A 13.50€

Chave para injetores BMW e VOLKSWAGEN

Quadra: 1/2"
Medida: 14mm
Comprimento: 119mm



AI050079 11.20€

Chave bujão caixa de velocidades e transmissões 1/2"

Marcas: AUDI e VOLKSWAGEN
Chave estriada XZN Tamperproof M16



AI050201 31.00€

Varetas para óleo

Aplicação: Audi/Volkswagen



AL010029 27.90€

Ferramenta de alinhamento dupla árvore cames motores gasolina

Marca	Modelo	Motorização	
AUDI	A2	1.4/ 1.6	
SEAT	Arosa/ Ibiza/ Cordoba/ Toledo/ Leon/ Inca	1.4/ 1.6	
	SKODA	Fabia/ Octavia	1.4/ 1.6
	VOLKSWAGEN	Lupo/ Polo/ Golf/ Bora/ Beetle/ Caddy	1.4/ 1.6

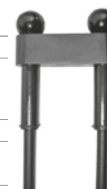

AL010053A 52.00€

Kit comando do motor

Marca	Modelo	Motorização	Ano
VOLKSWAGEN	Polo	1.2 6V/ 12V	2002>
SEAT	Ibiza	1.2 6V	2002>
SKODA	Fábia	1.2 6V/ 12V	2003>



AL010072
6.80€
Kit comando do motor

Marca	Modelo
AUDI	A4/ S3/ A6/ TT
SEAT	Ibiza/ Cordoba/ Leon/ Toledo/ Alhambra
SKODA	Octavia
VOLKSWAGEN	Golf/ Bora/ Beetle/ Passat

AL010087
169.00€
Kit comando de motor AUDI

Marca	Modelo	Motorização
AUDI	A4	3,2FSI
	A6	2,4
	A6	2,4quattro
	A6	3,2FSI A)
	A8	3,2FSI A

AL010088
68.00€
Kit comando de motor a gasolina

Marca	Modelo	Motorização
AUDI	A3	1.4L/ 1.6 FSI
SKODA	Octavia	
VOLKSWAGEN	Polo/ Golf/ Golf Plus/ Jetta/ Passat/ Touran	

AN010202
23.00€
Chave de impacto especial XZN 3/4" para cubos rodas AUDI/ VOLKSWAGEN

 Medida: M18
 Comprimento: 105mm

AN010202B
10.80€
Chave de impacto XZN 1/2" AUDI/ VOLKSWAGEN

Especialmente concebida para o aperto dos parafusos que fixam o eixo traseiro

 Medida: M18
 Comprimento: 78mm

AI010108
20.50€
Ajustador do rolete tensionador

Marca	Modelo
AUDI	A4/ A6/ Cabrio
SEAT	Ibiza
SKODA	Superb
VOLKSWAGEN	Polo/ EOS/ Passat

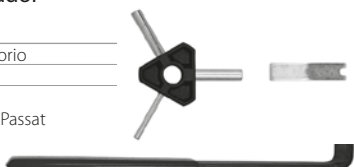
AI010110
179.50€
Jogo sincronismo motor - grupo VAS

Marca	Modelo	Motorização	Ano
AUDI	A3	1.6FSI	2003-2006
	A3/ S3	1.8Turbo	1996-2003
	A4/ A6	1.8Turbo	1994-2006
	Cabriolet		1997-2000
	TT	1.8Turbo	1998-2006
SEAT	Ibiza	1.8Turbo	1999-2002
	Cordoba	1.8Turbo	
	Leon	1.8Turbo	1999-2005
	Toledo	1.8Turbo	1999-2005
SKODA	Octavia	1.8Turbo	1996-2005
	Octavia	1.8Turbo	2000-2005
	20V RS		
VOLKSWAGEN	Golf	1.6FSI	
	Touran	1.6FSI	
	Beetle	1.8Turbo	1999-2006
	Golf/ Bora	1.8Turbo	1997-2005

AL010202
5.50€
Pino fixação cambota - grupo VAS

Esta chave é equivalente à ferramenta especial VAG T10340

Marca	Modelo	Motorização
VOLKSWAGEN	Polo/ Golf/ Golf VI Cabrio/ Golf Plus/ Golf Variant/ Touran/ EOS/ Passat/ Jetta/ Scirocco/ Beetle/ Sharan/ Tiguan/ Caddy/ Caddy Maxi/ Fox	1.4/1.6TSI/FSI
AUDI	A3	1.4/1.6TSI/FSI
SEAT	Cordoba/ Ibiza	1.4/1.6TSI/FSI
SKODA	Fabia/ Roomster	1.4/1.6TSI/FSI



Códigos de motor: AWY/ AXU/ AZQ/ BAG/ BBM/ BKG/ BLF/ BLG/ BLN/ BLP/ BMD/ BME/ BMY/ BTS/ BWK/ BZG/ CAVA/ CAVB/ CAVC/ CAVD/ CAXA/ CEVA/ CGPA/ CGPB/ CHFA

AL010203
5.50€
Pino de fixação da cambota - grupo VAS

Esta chave é equivalente à ferramenta especial VAG T40069

Marca	Motorização
AUDI/ SEAT/ SKODA/ VOLKSWAGEN	2.0/ 2.4/ 3.2FSI/ 3.0 V6 TDI/ 4.2 V8 TDI/ 2.8/ 1.4/ 1.6 TSI/FSI

Código de motor: BGP/ BGQ/ CBUA/ CBTA/ BPR/ BPS

AL010225
68.00€
Kit comando motores VOLKSWAGEN

Modelo	Motorização	Ano
Transporter	2.4D T4	1995>2003
Código de motor: AAB/ AJA		
Transporter	2.5TDI	1995>2003
Código de motor: ACV/ AHY/ AJT/ AUF/ AXG/ AXL/ AYC		
Crafter	2.5TDI	2006 >2012
Código de motor: BJJ/ BJK/ BJL/ BJM		



ME010001 355.00€

Jogo de guias para montagem de retentores suspensão

Composição:

Ref.	Compr. (mm)
329-01	449/50
329-02	45
329-03	43
329-04	41
329-05	39
329-06	35/36
329-07	48
329-08	54
329-09	46/47

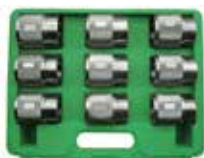

ME010007 26.50€

Chave de montagem/ desmontagem da forqueta invertida

Marca: Kayaba/ Showa

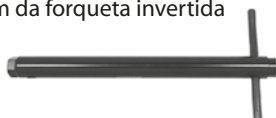

ME010009 9.80€

Saca pip de válvula de ar



ME010010 17.00€

Jogo de guias para casquilhos suspensão

Composição/ medidas (mm):
12,5; 14; 16 e 18



ME010012 28.00€

Guia para montagem/ desmontagem forqueta invertida



ME020001 31.00€

Removedor do rolamento da coluna da direção

Abertura: 30-68mm



ME020002 52.00€

Ferramenta para instalação rolamento da direção

Diâmetro da haste: 26, 30, 31 e 35mm



ME020003 268.00€

Saca do rolamento da haste da mesa da direção

Medidas (mm): 44, 48 e 51mm



ME020005 76.00€

Guia para instalação do rolamento da direção

Diâmetro da haste: 26, 30, 31 e 35mm



ME020006 220.00€

Dispositivo de instalação das caixas dos rolamentos cónicos na coluna de direção

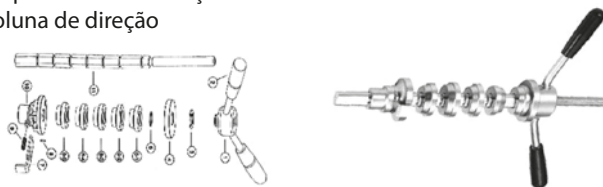

MG010001 28.50€

Saca cubo embraiagem/ polie alternador



MG01000

Chave fêmea da embraiagem

Ref.	Medida (mm)	Pinos	Preço
MG010002	34x59	2	17.50€
MG010003	41x59	2	17.80€
MG010004	39x72	2	20.50€
MG010005	46x72	2	20.50€
MG010006	46	3	20.50€

MG010008 26.00€

Ferramenta para comprimir embraiagem

Para motores 50 a 250cc
com polie de \varnothing 125 a 155mm



MG010009 34.00€

Ferramenta para comprimir embraiagem

Para motores 50 a 250cc
com polie de \varnothing 125 a 155mm



MG020001

30.50€

Corta corrente

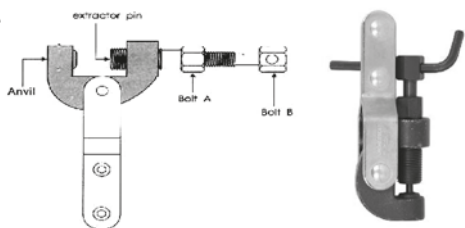

MG020003

68.00€

Corta/ rebitor da corrente



MG020004

10.00€

Alicate para o elo de fecho



MG020006

13.50€

Ferramenta de fecho da corrente (transmissão ou distribuição)



MG020007

49.80€

Kit limpeza da corrente



MG020008

12.60€

Escova limpa correntes



MI010014

20.00€

Saca válvulas do motor



MI010016

41.50€

Removedor/ instalador do pino do piston

Medidas (mm):

Pistões: 40 a 100

Pinos: 12 a 25



MI010017

20.70€

Instalador dos segmentos do pistão



MI010018

20.50€

Protetor em alumínio para torno



MI010019

170.00€

Ferramenta de auxílio para fecho do motor

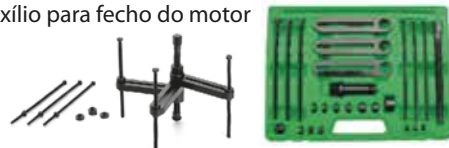

MI010020

23.70€

Ferramenta de bloqueio embraiagem/ volante scooter



MI010021

20.80€

Saca para volante magnético



MI020001

11.00€

Chaves para jets 6 e 8mm



MI020002

17.00€

Jogo de chaves para carburadores FCR



MI020004

23.00€

Medidor do nível da altura da bóia do carburador



MN020004

6.60€

Protetor de jantes



MN020005

4.40€

Descolador de pneus



MT010001

8.10€

Oleador de cabos

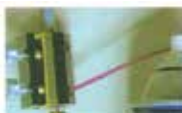

MT010002

42.00€

Ferramenta de furação da fêmea e parafuso de segurança



MT010003

113.00€

Cavalete para roda traseira



MT010004

110.00€

Suporte central universal



MT010005

20.40€

Chave ajustável bloqueio de embraiagem



MT010006

22.70€

Chave ajustável bloqueio de embraiagem



MT010007

33.50€

EZ-ROLL (sistema rotação roda traseira)



MT010008

8.00€

Gancho para molas



CHAPEIRO

AB010001

42.00€

Kit de 10 peças para montagem de vidros



AB010002

70.50€

Kit de remoção para vidros parabrisas



AB010002-A

13.30€

Bobine de arame para remoção de vidros - 15m



AB010017

16.90€

Faca parabrisas



AB0100

Lâmina em aço para faca parabrisas

Ref.	Medida	Preço
AB010018	3/4"	1.70€
AB010019	1"	1.70€
AB010020	1-1/2"	1.70€



AB010026S

28.00€

Removedor de frisos e plásticos



AB010041 38.00€

Jogo de 12 chaves para remoção de painéis



AB010042 138.00€

Espelho com luz auxiliar para reparação de mossas



AB010043 49.00€

Espelho auxiliar para reparação de mossas



AB020002 17.90€

Ventosa simples para vidros



AB020003 43.40€

Ventosa dupla para vidros



AB020009 40.00€

Ventosa dupla articulada para vidros

Estrutura em alumínio
Ventosas: ø115mm



AB020010 60.00€

Ventosa tripla para vidros

Estrutura em alumínio
Ventosas: ø123mm
Capacidade: 35 kg/100 kg



Chapeiro

AB020015 6.60€

Jogo de ventosas para colocar vidros



AB020019 35.20€

Jogo de 6 ventosas

Para auxílio durante a colagem de frisos, vidros, etc



AB030001 5.90€

Jogo de 4 espátulas de 25 a 100mm



AB030014 8.60€

Ferramenta para colocação borrachas nos vidros



AB030028 4.00€

Chave para cavilhas e encaixes plásticos



AB030041 4.30€

Chave para cavilhas e encaixes plásticos



AB030043 4.40€

Chave para cavilhas e encaixes plásticos

Encaixe em "V"



AB030046 4.20€

Chave para cavilhas e encaixes plásticos

Encaixe de 8mm



AB030047 3.20€

Chave para cavilhas e encaixes plásticos

Encaixe de 6mm



AB030048 6.00€

Chave para cavilhas e encaixes plásticos



AB030060 38.30€

Jogo de 2 alicates para molas plásticas



AB030068A 27.10€

Alavanca de chapeiro

Medida: 380mm



AB030068C 34.70€

Alavanca de chapeiro

Medida: 900mm



AB030068D 30.70€

Alavanca de chapeiro

Medida: 750mm



AB030068F 19.50€

Alavanca de chapeiro

Medida: 450mm



AB030069A 20.80€

Cunha de chapeiro

Medida: 125mm



AB030069B 26.50€

Cunha de chapeiro

Medida: 137mm



AB030069C 11.80€

Cunha de chapeiro

Medida: 92mm



AB030069E 7.30€

Cunha de chapeiro

Medida: 48mm



AB030070B 20.20€

Encontrador de dupla face



AB030070C 17.40€

Encontrador curvo



AB030070D 24.50€

Encontrador tipo vírgula

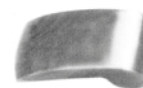

AB030089 126.50€

Jogo de 7 encontradores para alumínio em polietileno de alta densidade



AB030100 52.00€

Martelo para alumínio com acessórios



AB030071 32.00€

Martelo de cabeça redonda serrilhada



M10110 21.70€

Martelo de cabeça plana redonda e pena pontiaguda



M10210A 18.00€

Martelo de cabeça plana redonda e pena curva



M10210B 17.50€

Martelo de cabeça plana redonda e pena direita



M10410A

24.00€

Martelo de puxar com cabeça redonda plana e quadrada rendilhada picotada

M10410B

24.20€

Martelo de puxar com cabeça redonda plana e quadrada rendilhada normal

AG010023

10.10€

 Base para lixa em plástico ABS
Dimensões: 106x212mm

AG010024

27.50€

 Armação flexível para lima de chapeiro
Para limas de 355mm

AG010024

Lima para AG010024



Ref.	Serra	Compr.	Preço
AG010024-1	9	14"/355mm	27.50€
AG010024-2	12	14"/355mm	32.50€

AG010030A

145.00€

Jogo de martelos e encontradores

AG010185

89.00€

Alicata de rebordear

AG010055

20.40€

Desandador de percussão com acessórios

AG010055-B

2.70€

Jogo de 4 bits para AG010055/AG010138

Composição:

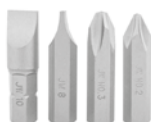
 Fenda: 8 e 10mm
Philips: PH2 e PH3

Chapeiro
AE310003

85.00€

Jogo de tira mossas

AE330004

59.00€

 Pinça de chapeiro uni-direcional
Capacidade: 3t

AE330005

66.00€

 Pinça de chapeiro bi-direcional
Capacidade: 2t (transversalmente)
3t (longitudinalmente)

AE330008

52.00€

 Pinça de chapeiro bi-direcional
Capacidade: 2t (puxar cruzado)
3t (puxar direito)

AE330009

116.00€

 Pinça de chapeiro tipo alicata uni-direcional
Capacidade: 3t

AE330013

120.00€

 Pinça de chapeiro bi-direcional
Capacidade: 3t (transversalmente)
5t (longitudinalmente)

AE330015

214.00€

 Pinça de chapeiro bi-direcional de 2 pontos
Capacidade: 5t

AE330016

41.50€

 Gancho para união de corrente
Capacidade: 6t

AE330030

78.00€

 Ponto fixo de puxar
Capacidade: 5t

AE330034

164.00€

Pinça de chapeiro de posição variável até 90°
Capacidade: 5t



AE330035

86.70€

Pinça de chapeiro
Capacidade: 5t



AG010138

19.40€

Desandador de percussão com 13 bits
Phillips: PH1; PH2; PH3 e PH4
Fenda: 5; 6; 8; 10 e 12mm
Hexagonais: 4; 5; 6 e 8mm



AG010138-B

6.70€

Jogo de 13 bits para AG010138/AG010055



AG010140

11.00€

Encontrador múltiplo



AG010141

56.00€

Punho para chapeiro com pontas intermutáveis



AG010142

52.00€

Martelo para chapeiro com pontas intermutáveis



AG010143

57.00€

Punho com punções e escopros intermutáveis



AL010113 30.00€

Chave de 1/2" para rodar cambota

Aplicação: SCANIA

AL010114 40.00€

Chave de 1/2" para alinhar cambota

Aplicação:

Marca Motorização

MERCEDES 6.8/ 10 cilindros

MAN 12 cilindros

AL010116 49.00€

Chave de 11 dentes para alinhar cambota

Medida: Parafuso hexagonal de 24mm

 Aplicação: DAF CF65/ CF75/ CF85/
F65/ F75/ F85/ F95/ XF95

AL010117 27.00€

Chave de 1/2" para alinhar cambota

Aplicação: DAF XF105 euro

AN010187 145.00€

Alicata para cintas de travões

Aplicação: VOLVO

AI010153 17.00€

Chave sensor de posição com 8 faces de 1/2"

Não utilizar com máquinas pneumáticas

Medida: 27mm

Comprimento: 60mm

Aplicação: MERCEDES Actros/ série SK/ MAN/ SCANIA

AI020164 26.50€

Chave para válvula eletromagnética com 8 faces de 3/4"

Medida: 38mm

Comprimento: 100mm

Aplicação: SCANIA

AI050135 120.00€

Jogo de chaves de copo para filtros - pesados

Composição:

Chave 6 faces 36mm

Chave 15 faces 74mm

Chave 15 faces 106mm

Chave 15 faces 107mm

Chave 15 faces 108mm

Chave 18 faces 108mm

Chave 18 faces 135mm

Chave de cinta Ø 160mm

Chave 21mm

AI050172 143.00€

Chave de filtros ajustável de 1/2"

Medida: 104-150mm

AN010235 55.00€

Chave de 3/4" para instalação/ remoção de fêmea embraiagem

Diâmetro interno: 64mm

Diâmetro externo: 79mm

Comprimento: 78mm

Espigões: 7mm

Aplicação: SCANIA

AN010237 110.00€

Extrator para articulações tirante de travões

Haldex

AN040062 30.00€

Chave montagem/ desmontagem de injetores

Aplicação: SCANIA/ MERCEDES/ MAN

AN040066 157.00€

Saca rótulas

Medida: 39mm

Aplicação: SCANIA/ MERCEDES/ MAN/ HINO

AN040105 133.00€

Chave para roda traseira com 8 faces de 1"

Medida: 100mm

Aplicação: SCANIA

AN040200 99.00€

Chave cubo para roda dianteira de 1"

Medida: 80mm

Aplicação: SCANIA

AG01016

Chave de rodas dupla

Ref.	Medida (mm)	Diâmetro travessão (mm)	Preço
AG010168	30x32	19 com 600	43.00€
AG010169	32x33	19 com 600	43.00€



AI050110

46.00€

Chave de filtros de corrente

Comprimento da corrente: 520mm
Filtros: 60-165mm



AN04005

Chave para remoção da tampa do cubo da roda traseira

Ref.	Medida (mm)	Preço
AN040055	111	130.00€
AN040056	120	130.00€

AB030076

Molas de plástico

Ref.	Quant. Embl.	Preço
AB030076-01	300	17.30€
AB030076-02	300	17.30€
AB030076-03	200	17.30€
AB030076-05	150	15.10€
AB030076-06	150	15.10€
AB030076-07	200	17.30€
AB030076-11	200	17.30€
AB030076-13	200	17.30€
AB030076-14	100	18.40€
AB030076-15	100	18.40€
AB030076-17	100	18.40€
AB030076-18	200	17.30€
AB030076-20	200	17.30€
AB030076-21	100	18.60€
AB030076-24	100	18.60€
AB030076-26	100	22.00€
AB030076-27	100	22.00€
AB030076-28	100	22.00€
AB030076-30	100	18.40€
AB030076-32	100	18.40€
AB030076-34	200	31.80€

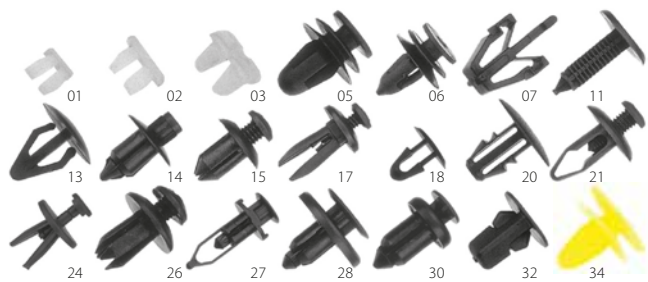

AB030076-00

72.50€

Jogo de 21 tipos de molas com 20 peças de cada
Caixa plástica



AI020158

86.70€

Jogo de 150 anilhas de cobre para injetores com 15 medidas

Composição:

13,85x7,3x1,4; 14,60x7,5x1,3; 14,60x7,5x3,0; 15x7x2;
15x7,5x1; 15x7,5x1,5; 15x7,5x2; 15x7,5x2,5; 15x7,5x3;
15,5x7,5x2; 16x7,5x1,5; 16x7,5x1,7; 16x7,5x2; 16x7,4x2
e 20x9,4x0,9



AR030022

60.20€

Jogo de 530 terminais auto com 18 tipos



AR030024

32.00€

Jogo de 270 vedantes para sistemas A/C

Composição:

4,47x1,78; 5,28x1,78; 6,07x1,78; 6,80x1,90; 7,65x1,78;
8x2; 8,80x1,90; 9,25x1,78; 10,82x1,78; 10,77x2,62;
12x2; 13x2; 13,95x2,62; 14x2; 15x2; 15,54x2,62;
17,17x1,78 e 20,22x3,53





JONNESWAY®

Ferramenta Pneumática



**Ferramenta
pneumática**

**Acessórios
para redes de
ar comprimido**



JAI-1024

169.00€

Máquina compacta de impacto de 1/2"

Caraterísticas:

Rotações em vazio:	10 000rpm
Torque trabalho:	510Nm
Torque máximo:	570Nm
Comprimento:	99mm
Peso:	1 400g
Consumo ar:	127l/min
Pressão de funcionamento:	6,2bar
Ruído:	97dB



JAI-1024-RK

9.90€

Kit de reparação para JAI-1024



JAI-1124

175.00€

Máquina compacta de impacto de 1/2"

Máquina ultra leve em compósito com mecanismo de 2 percutores e 3 velocidades de aperto e 1 velocidade de desaperto (potência máxima). Cobertura frontal em liga alumínio resistente.

Caraterísticas:

Rotações em vazio:	9 500rpm
Torque trabalho:	560Nm
Torque máximo:	620Nm
Comprimento:	112mm
Peso:	1 150g
Consumo ar:	136l/min
Pressão de funcionamento:	6,2bar
Ruído:	99,9dB



BREAKAWAY

torque 1 100Nm

JAI-1124-RK

11.50€

Kit de reparação para JAI-1124



JAI-1114

180.00€

Máquina de impacto de 1/2"

Máquina em compósito preparada para trabalho intensivo com mecanismo de 2 percutores.

Caraterísticas:

Rotações em vazio:	9 500rpm
Torque trabalho:	745Nm
Torque máximo:	935Nm
Comprimento:	190mm
Peso:	2 300g
Consumo ar:	207l/min
Pressão de funcionamento:	6,2bar
Ruído:	99,2dB



JAI-1114-RK

13.00€

Kit de reparação para JAI-1114

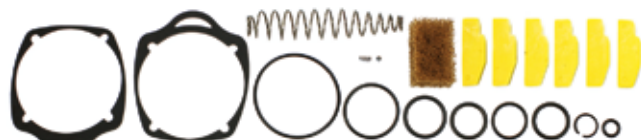

JAI-1232K

152.00€

Máquina para remoção de velas de incandescência de 1/4" com kit de chaves

Máquina com comutador de direção incorporado no botão de acionamento, permitindo efetuar a mudança de direção só com uma mão. 4 Posições reguláveis para 20; 30; 40 e 45Nm

Caraterísticas:

Rotações em vazio:	11 000rpm
Torque:	20-45Nm
Comprimento:	180mm
Peso:	800g
Consumo ar:	150l/min
Pressão de funcionamento:	6,2bar
Ruído:	102dB

Acessórios:

Chaves caixa longas: 8; 9; 10; 11 e 12mm
Cardan
Extensão



JAI-1232-RK

12.50€

Kit de reparação para JAI-1232



JAI-6202K

200.00€

Máquina de impacto de 1/2" com kit de chaves
Máquina com mecanismo pin clutch.

Caraterísticas:

Rotações em vazio: 7 000rpm
Torque trabalho: 516Nm
Peso: 2 700g
Interior mangueira: 10mmø

Acessórios:



Chaves: 9; 10; 11; 13; 14; 17; 19;
22; 24 e 27mm
Extensão: 75mm
Chave hexagonal: 4mm
Kit manutenção



JAI-6202-RK

54.50€

Kit de reparação para JAI-6202



JAI-0501K

263.00€

Máquina de impacto de 1/2" com kit de chaves
Máquina com mecanismo de 2 percutores.

Caraterísticas:

Rotações em vazio: 7 000rpm
Torque máximo: 610Nm
Comprimento: 190mm
Peso: 2 660g
Interior magueira: 10mmø

Acessórios:



Chaves: 9; 10; 11; 13; 14; 17; 19;
22; 24 e 27mm
Extensão: 75mm
Chave hexagonal: 4mm
Kit manutenção
Mala



JAI-0501-RK

18.80€

Kit de reparação para JAI-0501

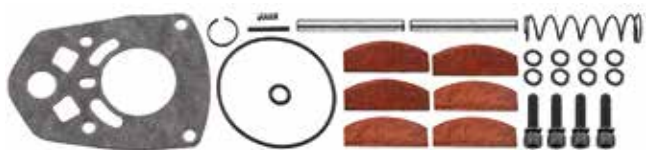

Ferramenta pneumática

JAI-1054

210.00€

Máquina de impacto de 1/2"

Máquina para trabalho intensivo com mecanismo de 2 percutores.

Caraterísticas:

Rotações em vazio: 8 000rpm
Torque trabalho: 780Nm
Torque máximo: 920Nm
Comprimento: 186mm
Peso: 2 560g
Interior mangueira: 13mmø
Consumo ar: 119l/min
Ruído: 90dB



JAI-1054-RK

22.00€

Kit de reparação para JAI-1054

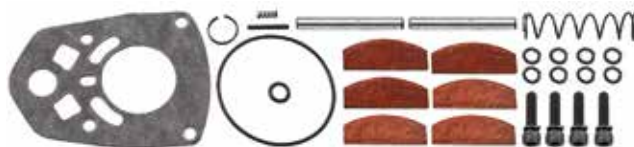

JAI-1513

225.00€

Máquina pneumática de impacto angular de 3/8"

Caraterísticas:

Rotações em vazio: 6 500rpm
Torque trabalho: 339Nm
Torque máximo: 380Nm
Comprimento: 248mm
Peso: 1 350g
Interior mangueira: 10mmø
Consumo ar: 119l/min
Ruído: 105dB



JAI-1513-RK

18.50€

Kit de reparação para JAI-1513



JAI-1514

221.00€

Máquina pneumática de impacto angular de 1/2"

Caraterísticas:

Rotações em vazio: 6 500rpm
Torque trabalho: 407Nm
Torque máximo: 460Nm
Comprimento: 248mm
Peso: 1 400g
Interior mangueira: 10mmø
Consumo ar: 119l/min
Ruído: 105dB



JAI-1514-RK

19.00€

Kit de reparação para JAI-1514



JAI-0926-RK

38.50€

Kit de reparação para JAI-0926



JAI-0936

580.00€

Máquina de impacto de 3/4"

Máquina em compósito preparada para trabalho intensivo com mecanismo de 2 percutores.

Caraterísticas:

Rotações em vazio: 6 500rpm
 Torque trabalho: 1 620Nm
 Torque máximo: 2 025Nm
 Comprimento: 225mm
 Peso: 1 940g
 Interior mangueira: 13mmø
 Consumo ar: 190l/min
 Ruído: 90,5dB



JAI-0936-RK

57.00€

Kit de reparação para JAI-0936



JAI-6212K

390.00€

Máquina de impacto de 3/4" com kit de chaves

Máquina com mecanismo pin clutch.

Caraterísticas:

Rotações em vazio: 4 800rpm
 Torque máximo: 1 086Nm
 Peso: 4 900g
 Interior mangueira: 13mmø

Acessórios:

Chaves: 26-38mm
 Kit manutenção
 Mala



JAI-6212-RK1

18.00€

Kit de reparação para JAI-6212

JAI-6211

359.00€

Máquina de impacto de 3/4" (19mm)

Máquina com mecanismo de 2 percutores.

Caraterísticas:

Rotações em vazio: 6 500rpm
 Torque máximo: 1 016Nm
 Peso: 4 550g
 Interior mangueira: 13mmø



JAI-6211-RK

32.00€

Kit de reparação para JAI-6211



JAI-1206L

780.00€

Máquina de impacto de 3/4"

Máquina para trabalho intensivo com veio longo e mecanismo de 2 percutores.

Caraterísticas:

Rotações em vazio: 5 500rpm
 Torque trabalho: 2 100Nm
 Torque máximo: 2 300Nm
 Comprimento: 465mm
 Peso: 6 400g
 Interior mangueira: 19mmø
 Consumo ar: 212l/min
 Ruído: 106dB



JAI-1206L-RK

53.00€

Kit de reparação para JAI-1206



JAI-0938

655.00€

Máquina de impacto de 1"

Máquina em compósito para trabalho intensivo com mecanismo de 2 percutores.

Caraterísticas:

Rotações em vazio: 6 500rpm
 Torque trabalho: 1 740Nm
 Torque máximo: 2 150Nm
 Comprimento: 230mm
 Peso: 4 100g
 Consumo ar: 190l/min
 Pressão de funcionamento: 6,2bar
 Ruído: 190,5dB



JAI-0938-RK

55.50€

Kit de reparação para JAI-0938



JAI-1138

725.00€

Máquina de impacto de 1"

Máquina de veio curto com mecanismo de 2 percutores.

Caraterísticas:

Rotações em vazio: 5 000rpm
 Torque trabalho: 2 430Nm
 Torque máximo: 2 712Nm
 Comprimento: 346mm
 Peso: 8 200g
 Interior mangueira: 19mmø
 Consumo ar: 255l/min
 Ruído: 100dB



JAI-1138-RK

89.00€

Kit de reparação para JAI-1138/ JAI-1138L



JAI-1138L

760.00€

Máquina de impacto de 1"

Máquina de veio longo com mecanismo de 2 percutores.

Caraterísticas:

Rotações em vazio: 5 000rpm
 Torque trabalho: 2 430Nm
 Torque máximo: 2 712Nm
 Comprimento: 487mm
 Peso: 8 300g
 Interior mangueira: 19mmø
 Consumo ar: 255l/min
 Ruído: 100dB



JAI-1408

1 165.00€

Máquina de impacto pesados de 1"

Máquina de veio curto.

Caraterísticas:

Rotações em vazio: 4 800rpm
 Torque trabalho: 3 270Nm
 Torque máximo: 3 520Nm
 Comprimento: 370mm
 Peso: 10 500g
 Consumo ar: 450l/min
 Pressão de funcionamento: 6,3bar
 Ruído: 105,5dB



JAI-1408-RK

73.50€

Kit de reparação para JAI-1408/ JAI-1408L



JAI-1408L

1 250.00€

Máquina de impacto pesados de 1"
Máquina de veio longo.

Caraterísticas:

- Rotações em vazio: 4 800rpm
- Torque trabalho: 3 270Nm
- Torque máximo: 3 520Nm
- Comprimento: 570mm
- Peso: 11 900g
- Consumo ar: 450l/min
- Pressão de funcionamento: 6,3bar
- Ruído: 105,5dB



JAR-1012

78.50€

Roquete pneumático de 1/4"

Caraterísticas:

- Rotações em vazio: 230rpm
- Torque máximo: 40Nm
- Comprimento: 140mm
- Peso: 469g
- Interior mangueira: 10mmø
- Consumo ar: 338l/min



JAR-1012-RK

30.00€

Kit de reparação para JAR-1012



JAR-1013

82.00€

Roquete pneumático de 3/8"

Caraterísticas:

- Rotações em vazio: 230rpm
- Torque máximo: 40Nm
- Comprimento: 140mm
- Peso: 469g
- Interior mangueira: 10mmø
- Consumo ar: 338l/min



JAR-1013-RK

30.00€

Kit de reparação para JAR-1013



JAR-1094

105.00€

Roquete pneumático de 1/2"

Caraterísticas:

- Rotações em vazio: 170rpm
- Torque máximo: 100Nm
- Comprimento: 275mm
- Peso: 1 400g
- Interior mangueira: 10mmø
- Consumo ar: 113l/min
- Ruído: 87dB



JAR-1094-RK

33.00€

Kit de reparação para JAR-1094



JAR-6309AK

127.00€

Roquete pneumático de 1/2" com kit de chaves

Caraterísticas:

- Rotações em vazio: 170rpm
- Torque máximo: 100Nm
- Comprimento: 275mm
- Peso: 1 400g
- Interior mangueira: 10mmø



Acessórios:



- Chaves: 9; 10; 11; 13; 14; 17 e 19mm
- Extensão: 75mm
- União universal de 1/2"
- Bits e porta bits
- Mala

JAR-6309A-RK

26.00€

Kit de reparação para JAR-6309A



JAR-6310A

93.00€

Roquete pneumático de 3/8"

Caraterísticas:

- Rotações em vazio: 170rpm
- Torque máximo: 100Nm
- Comprimento: 275mm
- Peso: 1 300g
- Interior mangueira: 10mmø



JAR-6310A-RK

25.00€

Kit de reparação para JAR-6310A



JAR-6310AK

130.00€

Roquete pneumático de 3/8" com kit de chaves

Caraterísticas:

Rotações em vazio: 170rpm
 Torque máximo: 100Nm
 Comprimento: 275mm
 Peso: 1 300g
 Interior mangueira: 10mmø



Acessórios:



Chaves: 9; 10; 11; 13; 14; 17 e 19mm
 Extensão: 75mm
 União universal de 3/8"
 Bits e porta bits
 Mala

JAR-1033

270.00€

Roquete pneumático combinado de 3/4" com kit de chaves

Caraterísticas:

Rotações em vazio: 180rpm
 Torque máximo: 107Nm
 Comprimento: 9,5mm
 Peso: 1 400g
 Interior mangueira: 10mmø



Acessórios:



Chaves: 8 a 19mm
 Adaptadores

JAR-1033-RK

69.00€

Kit de reparação para JAR-1033A



JAD-0413

107.00€

Berbequim reversível pneumático de 3/8"

Caraterísticas:

Rotações em vazio: 1 800rpm
 Motor: 0,4cv
 Capacidade da bucha: 10mm
 Comprimento: 210mm
 Peso: 950g
 Interior mangueira: 10mmø
 Consumo ar: 99l/min
 Vibração: 3,3m/s²
 Ruído: 80dB



JAD-0413-RK

11.00€

Kit de reparação para JAD-0413



JAD-1020

103.00€

Berbequim reversível pneumático de 1/2"

Caraterísticas:

Rotações em vazio: 800rpm
 Capacidade da bucha: 13mm (aperto com chave)
 Comprimento: 220mm
 Peso: 1 300g
 Interior mangueira: 10mmø



JAD-1020-RK

2.30€

Kit de reparação para JAD-1020



JAD-1021

106.00€

Berbequim pneumático angular de 3/8"

Caraterísticas:

Rotações em vazio: 1 900rpm
 Capacidade da bucha: 10mm (aperto com chave)
 Comprimento/ altura: 190x110mm
 Peso: 960g
 Interior mangueira: 10mmø
 Consumo ar: 280l/min



JAD-1021-RK

12.50€

Kit de reparação para JAD-1021



JAD-1027

125.00€

Berbequim reversível pneumático de 1/2"

Caraterísticas:

Rotações em vazio: 800rpm
 Capacidade da bucha: 13mm (aperto sem chave)
 Comprimento: 178mm
 Peso: 1 820g
 Interior mangueira: 10mmø



JAD-1027-RK

2.20€

Kit de reparação para JAD-1027



JAD-6252A

65.00€

Berbequim pneumático de 3/8"

Caraterísticas:

- Rotações em vazio: 2 500rpm
- Capacidade da bucha: 9,5mm (aperto com chave)
- Comprimento: 228mm
- Peso: 900g
- Interior mangueira: 10mmø



JAD-6252A-RK

3.60€

Kit de reparação para JAD-6252



JAB-1017

95.00€

Aparafusadora pneumática reversível de 1/4"

Caraterísticas:

- Rotações em vazio: 1 800rpm
- Capacidade da bucha: 1/4"
- Comprimento: 190mm
- Peso: 1 100g
- Interior mangueira: 10mmø



JAB-1017-RK

1.90€

Kit de reparação para JAB-1017



JAB-1018

108.00€

Aparafusadora pneumática reversível de 1/4"

Caraterísticas:

- Rotações em vazio: 800rpm
- Capacidade da bucha: 1/4"
- Comprimento: 226mm
- Peso: 1 300g
- Interior mangueira: 10mmø



JAB-1018-RK

1.90€

Kit de reparação para JAB-1018



JAB-7003A

114.00€

Aparafusadora pneumática reversível de 1/4"

Caraterísticas:

- Rotações em vazio: 1 800rpm
- Capacidade da bucha: 1/4"
- Comprimento: 254mm
- Peso: 1 140g
- Interior mangueira: 10mmø



JAB-7003A-RK

4.20€

Kit de reparação para JAB-7003A



JAD-1015K

317.00€

Máquina pneumática de descravar pontos com kit de acessórios

Caraterísticas:

- Rotações em vazio: 1 800rpm
- Capacidade de furo: 8mm
- Comprimento: 254mm
- Peso: 2 100g
- Interior mangueira: 10mmø



Acessórios:



- Chave hexagonal: 2,5mm
- Brocas
- Lubrificador
- Ligador: 1/4"x1/4"
- Mala

JAD-1015-RK

2.40€

Kit de reparação para JAD-1015K



JAZ-7207

75.00€

Jogo de 5 brocas para máquina descravar

Aplicável aos modelos: JAD-1015/ JAD-6246

Caraterísticas:

- Brocas em HSS e cobalto
- Diâmetro: 6,5mmø



JAG-0903-MS

12.50€

Jogo de 10 buris

Aplicável aos modelos:

JAG-0903/ JAG-0906/ JAG-0913/ JAG-0923/ JAG-0925/ JAG-0955



JAG-0906RMK
77.00€
Retificadora pneumática de 1/4" com kit de acessórios
Caraterísticas:

Rotações em vazio:	22 000rpm
Capacidade da pinça:	6mm
Potência:	0,4Kw
Comprimento:	175mm
Peso:	490g
Interior mangueira:	10mmø

Acessórios:

Buris: 6mm (1/4")
 Buris: 3mm (1/8")
 Chaves
 Redução: 3mm (1/8")
 Mala

JAG-0906R/RM-RK
7.50€
Kit de reparação para JAG-0906RMK

JAG-0913RMK
98.00€
Retificadora pneumática angular de 1/4" com kit acessórios
Caraterísticas:

Rotações em vazio:	18 000rpm
Capacidade da pinça:	6mm
Potência:	0,21Kw
Comprimento:	155mm
Peso:	490g
Interior mangueira:	10mmø

Acessórios:

Buris: 6mm (1/4")
 Buris: 3mm (1/8")
 Chaves
 Redução: 3mm (1/8")
 Mala

JAG-0913RM-RK
5.30€
Kit de reparação para JAG-0913RMK

JAG-0923RM
48.00€
Mini retificadora pneumática de 1/4"
Caraterísticas:

Rotações em vazio:	25 000rpm
Capacidade da pinça:	6mm
Potência:	0,5hp
Comprimento:	170mm
Peso:	700g
Consumo ar:	76l/min
Pressão de funcionamento:	6,2bar
Ruído:	97dB

JAG-0923RM-RK
5.90€
Kit de reparação para JAG-0923RM

JAG-0925RM
50.00€
Retificadora pneumática de 1/4"
Caraterísticas:

Rotações em vazio:	22 000rpm
Capacidade da pinça:	6mm
Potência:	0,5hp
Comprimento:	170mm
Peso:	700g
Consumo ar:	113l/min
Pressão de funcionamento:	6,2bar
Ruído:	97dB

JAG-0925RM-RK
16.50€
Kit de reparação para JAG-0925RM

JAG-0955RM
82.00€
Retificadora pneumática de 1/4"
Caraterísticas:

Rotações em vazio:	22 000rpm
Capacidade da pinça:	6mm
Potência:	0,5hp
Comprimento:	260mm
Peso:	700g
Consumo ar:	113l/min
Pressão de funcionamento:	6,2bar
Ruído:	97dB

JAG-0955RM-RK
6.70€
Kit de reparação para JAG-0955RM

JAG-1087

140.00€

Micro retificadora pneumática

Caraterísticas:

Rotações em vazio:	60 000rpm
Bucha:	3mm
Interior mangueira:	10mmø
Peso:	220g
Consumo ar:	180l/min
Dimensões:	17x120mm



JAG-1087-RK

22.50€

Kit de reparação para JAG-1087



JAG-6638

138.00€

Rebarbadora pneumática angular de 125mm

Caraterísticas:

Rotações em vazio:	11 000rpm
Dimensão do disco:	125mm
Potência:	0,7Kw
Comprimento:	230mm
Peso:	1 800g
Interior mangueira:	10mmø
Vibração do punho:	6,45m/s ²
Ruído:	86dB



JAG-6638-RK

64.00€

Kit de reparação para JAG-6638



JAG-6639

283.00€

Rebarbadora pneumática angular de 180mm

Caraterísticas:

Rotações em vazio:	7 000rpm
Dimensão do disco:	180mm (7")
Potência:	1,4Kw
Comprimento:	343mm
Peso:	3 100g
Interior mangueira:	10mmø



JAG-6639-RK

85.00€

Kit de reparação para JAG-6639



JAS-6505

125.00€

Lixadora de disco de 180mm

Caraterísticas:

Rotações em vazio:	4 500rpm
Dimensão do disco:	178mm
Rosca do veio:	5,8" (11UNC)
Comprimento:	406mm
Peso:	2 500g
Interior mangueira:	10mmø



JAS-6505-RK

5.10€

Kit de reparação para JAS-6505



JAS-6551

128.00€

Lixadora de disco de 180mm

Caraterísticas:

Rotações em vazio:	2 500rpm
Dimensão do disco:	178mm
Rosca do veio:	5,8" (11UNC)
Comprimento:	406mm
Peso:	2 500g
Interior mangueira:	10mmø



JAS-6551-RK

5.50€

Kit de reparação para JAS-6551



JAS-6552

125.00€

Polidora pneumática de 180mm

Caraterísticas:

Rotações em vazio:	2 500rpm
Dimensão do disco:	178mm
Peso:	2 800g
Interior mangueira:	10mmø
Consumo ar:	260l/min



JAS-6552-RK

16.00€

Kit de reparação para JAS-6552



JAS-0010

212.00€

Lixadora com base triangular em vinil

Caraterísticas:

Rotações em vazio: 9 000rpm
 Dimensão da base: 93x132mm
 Interior mangueira: 10mmø
 Consumo ar: 260l/min



JAS-0010-RK

21.00€

Kit de reparação para JAS-0010



JAS-0010-41

19.40€

Base para lixadora JAS-0010

Dimensão da base: 93x132mm



JAS-0413

120.00€

Lixadora orbital angular

Máquina em compósito

Caraterísticas:

Rotações em vazio: 15 000rpm
 Dimensão do disco: 76mm
 Órbita: 3mm
 Motor: 0,4cv
 Comprimento: 125mm
 Peso: 720g
 Interior mangueira: 10mmø
 Consumo ar: 99l/min
 Vibração: 6,3m/s²
 Ruído: 80dB



JAS-0413-RK

9.50€

Kit de reparação para JAS-0413



JAS-0423K

152.00€

Polidora angular

Máquina em compósito

Caraterísticas:

Rotações em vazio: 2 100rpm
 Dimensão do disco: 76mm
 Motor: 0,4cv
 Comprimento: 135mm
 Peso: 770g
 Consumo ar: 99l/min
 Pressão de funcionamento: 6,2bar
 Vibração: 2,3m/s²
 Ruído: 78dB



JAS-0423-RK

21.00€

Kit de reparação para JAS-0423



JAS-1021-6HE(2.5)

195.00€

Lixadora orbital angular com base em vinil aderente com 6"

Máquina em compósito

Caraterísticas:

Rotações em vazio: 12 000rpm
 Dimensão do disco: 150mm
 Órbita: 2,5mm
 Peso: 960g
 Interior mangueira: 10mmø
 Consumo ar: 170l/min



JAS-1021-6HE-RK

9.60€

Kit de reparação para JAS-1021-6HE



JAS-1206-6HE

299.00€

Lixadora orbital para ligação a central de aspiração com base em vinil aderente com 6"

Máquina em compósito

Caraterísticas:

Rotações em vazio: 12 000rpm
 Dimensão do disco: 150mm
 Órbita: 5mm
 Interior mangueira: 10mmø



JAS-1206-6HE-RK

43.00€

Kit de reparação para JAS-1206-6HE



JAS-1206-6HP

47.00€

Base com velcro para lixadora JAS-1206/ JAS-1207 com 6"



JAS-1207-6HE

355.00€

Lixadora orbital com auto aspiração com base em vinil aderente com 6"

Máquina em compósito

Caraterísticas:

Rotações em vazio: 12 000rpm
 Dimensão do disco: 150mm
 Órbita: 5mm
 Interior mangueira: 10mmø
 Saco para recolha de pó



JAS-1207-6HE-RK

43.00€

Kit de reparação para JAS-1207-6HE



JAS-1207-6HE-56

25.00€

Saco em tecido para proteção do saco papel de recolha de pó para JAS-1207-6HE.



JAS-1207-6HE-57

3.20€

Saco em papel para recolha de pó para JAS-1207-6HE



JAS-1206-6HP

47.00€

Base com velcro para lixadora JAS-1206/ JAS-1207 com 6"



JAS-1031-6HE

201.00€

Lixadora orbital com base em velcro com 6"

Máquina em compósito

Caraterísticas:

Rotações em vazio: 10 000rpm
 Dimensão do disco: 150mm
 Órbita: 5mm
 Peso: 1 040g
 Interior mangueira: 10mmø



JAS-1031-6HE-RK

50.00€

Kit de reparação para JAS-1031-6HE

JAS-1031-6VE-RK

54.00€

Kit de reparação para JAS-1031-6VE

JAS-1031-6HP

21.00€

Base em velcro para lixadora JAS-1031/ JAS 6535-6HE



JAS-6531

135.00€

Lixadora retangular estreita

Máquina em compósito

Caraterísticas:

Movimentos/ minuto: 2 500
 Dimensão da base: 63,5x407mm
 Comprimento: 406mm
 Peso: 3 100g
 Interior mangueira: 10mmø
 Consumo ar: 226l/min
 Ruído: 93,3dB



JAS-6531-RK

2.40€

Kit de reparação para JAS-6531

JAS-6535-5HE

182.00€

Lixadora orbital com base em velcro com 5"

Máquina em compósito

Caraterísticas:

Rotações em vazio: 10 000rpm
 Dimensão do disco: 125mm
 Órbita: 5mm
 Peso: 1 040g
 Interior mangueira: 10mmø



JAS-6535-5HE-RK

47.50€

Kit de reparação para JAS-6535-5HE

JAS-6535-5HE-47

18.00€

Base em velcro para JAS-6535-5HE

JAS-6535-5VE-RK

35.50€

Kit de reparação para JAS-6535-5VE

JAS-6535-6HE

175.00€

Lixadora orbital com base em velcro com 6" Máquina em compósito

Características:

Rotações em vazio:	10 000rpm
Dimensão do disco:	150mm
Órbita:	5mm
Peso:	1 040g
Interior mangueira:	10mmø

JAS-6535-6HE-RK

45.00€

Kit de reparação para JAS-6535-6HE

JAS-1031-6HP

21.00€

Base em velcro para lixadora JAS-1031/ JAS 6535-6HE

JA-6111(1.4)

100.00€

Pistola de pintura tipo gravidade

Características:

Entrada ar:	1/4"
Capacidade copo nylon:	600ml
Bico standard:	1,4mm

JA-6111

Kit de bico para pistola JA-6111

Ref.	Medida (mm)	Preço
JA-6111-NS13	1.3	38.50€
JA-6111-NS17	1.7	38.50€
JA-6111-NS20	2	38.50€

Ferramenta pneumática
JA-6111K

215.00€

Jogo de pistola de pintura tipo gravidade e acessórios

Características:

Pistola:	JA-6111
Capacidade copo nylon:	250 e 600 ml
Bicos:	1,7 e 2mm
Interior mangueira:	10mmø
Kit de limpeza	
Mala	

JA-HVLP-1080GK

280.00€

Jogo de pistola de pintura HVLP e acessórios

Características:

Pistola:	JA-HVLP-1 080G
Capacidade copo nylon:	250 e 600ml
Bicos:	1,4; 1,7 e 2mm
Interior mangueira:	10mmø
Kit de limpeza	
Mala	

JA-HVLP-1080GD-N1.4

52.00€

Bico de 1.4 para pistola JA-HVLP-1 080GD

JA-HVLP-300C (1.3)

165.00€

Pistola de pintura tipo gravidade

Características:

Entrada ar:	1/4"
Capacidade copo nylon:	600 ml
Bico standard:	1,3mm
Pressão ar:	2bar
Consumo ar:	481l/min
Peso:	545g
Interior mangueira:	10mmø

JA-HVLP-3000-NS17

61.50€

Kit bico 1.7 para pistola de pintura

JA-HVLP-3000-NS19

61.50€

Kit bico 1.9 para pistola de pintura

JA-300C-NS13

61.00€

Bico completo 1.3 para pistola de pintura JA-HVLP3000/ JA-HVLP300C



JA-LVLP-0303W

165.00€

Pistola de pintura para tintas à base de água tipo gravidade

Caraterísticas:

Entrada ar: 1/4"
 Capacidade copo nylon: 600ml
 Bico standard: 1,3mm
 Interior mangueira: 10mmø



JA-LVLP-0303W-N

48.50€

Kit bico 1.3 para pistola de pintura

JA-LVLP-0303W-N18

48.50€

Kit bico 1.8 para pistola de pintura

JA-HVLP-6112

148.00€

Pistola de pintura tipo gravidade

Caraterísticas:

Entrada ar: 1/4"
 Capacidade copo nylon: 125ml
 Bico standard: 1mm
 Pressão ar: 3bar
 Consumo ar: 112l/min
 Peso: 240g
 Interior mangueira: 10mmø



ACC-609

20.40€

Regulador de ar 0-10 bar



JA-3806C

10.00€

Regulador de pressão para pistola de pintura

Aplicável à pistola JA-HVLP-6112



JA-3808A

9.90€

Separador de óleo/ água para pistolas de pintura



JA-0001RK

5.30€

Kit de reparação para pistola de pintura



AS-0026

11.50€

Kit de limpeza para pistolas de pintura com 12 peças



AS-0013A2

25.50€

Copo de alumínio para pistola de pintura tipo gravidade

Capacidade: 600ml



AS-001

Copo para pistola de pintura

Ref.	Capacidade (ml)	Preço
AS-0013	600	12.00€
AS-0015	125	9.00€



JA-300C-28

12.00€

Copo para pistola de pintura JA-HVLP-3000

Capacidade: 600ml

Tampa não incluída



AS-001

Tampa para copo de pistola de pintura

Ref.	Capacidade (ml)	Preço
AS-0013C	600	2.50€
AS-0015C	250	2.40€



JA-950 62.00€

Pistola de secagem para tintas à base de água

JA-950-04 3.00€

Filtro de rede para pistola JA-950

JA-960 180.00€

 Suporte para 2 pistolas de secagem
 Não inclui as pistolas

JAS-0452 185.00€

 Lixadora de faixa larga
 Máquina em compósito

Caraterísticas:

Rotações em vazio: 16 000rpm
 Dimensão da base: 20x520mm
 Comprimento: 430mm
 Peso: 1 400g
 Interior mangueira: 10mmø
 Consumo ar: 113l/min
 Vibração: 2,8m/s²
 Ruído: 95dB

JAS-0452-RK 34.00€

Kit de reparação para JAS-0452

JAS-6542 182.00€

Lixadora de faixa larga

Caraterísticas:

Rotações em vazio: 16 000rpm
 Dimensão da base: 20x520mm
 Comprimento: 360mm
 Peso: 1 200g
 Interior mangueira: 10mmø

JAS-6542-RK 24.00€

Kit de reparação para JAS-6542

Ferramenta pneumática
JAS-6543 110.00€

Lixadora de faixa estreita

Caraterísticas:

Rotações em vazio: 16 000rpm
 Dimensão da base: 10x330mm
 Comprimento: 290mm
 Peso: 800g
 Interior mangueira: 10mmø

JAS-6543-RK 19.50€

Kit de reparação para JAS-6543

JAT-1020K 245.00€

 Serra/ lima pneumática de baixa vibração com kit de acessórios
 Mecanismo de baixa vibração

Caraterísticas:

Oscilação por minuto: 16 000bpm
 Curso: 25mm
 Peso: 960g
 Interior mangueira: 10mmø



Acessórios:



Lâminas: T14; T18 e T24
 Limas
 Mala

JAT-1020-RK 55.00€

Kit de reparação para JAT-1020

JAT-12F

Limas para JAT-1020

Ref.	Forma	Preço
JAT-12F1	triangular	5.80€
JAT-12F2	meia cana	6.20€
JAT-12F3	redonda	5.80€
JAT-12F4	chata	5.80€

JAT-20T

Serras para JAT-1020

Ref.	Dentes	Preço
JAT-20T14	14	4.10€
JAT-20T18	18	4.10€
JAT-20T24	24	4.10€



JAT-1041

165.00€

Assentador pneumático de válvulas

Caraterísticas:

- Oscilação por minuto: 3 000bpm
- Capacidade máxima: 4,5mmø
- Comprimento: 153,5mm
- Peso: 1 550g
- Interior mangueira: 10mmø
- Consumo ar: 100l/min
- Ventosas: 16; 20; 30 e 35mm



JAT-1041-16S

15.50€

Jogo de 4 ventosas para JAT-1041

Caraterísticas:

- Medidas: 16; 20; 30 e 35mm

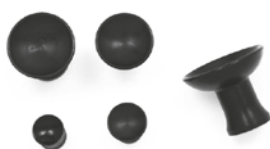

JAT-1011

137.00€

Serra pneumática de baixa vibração

Caraterísticas:

- Oscilação por minuto: 11 000bpm
- Curso: 8mm
- Peso: 450g
- Interior mangueira: 10mmø
- Consumo ar: 90l/min
- Ruído: 86,8dB



JAT-1011-RK

25.00€

Kit de reparação para JAT-1011

JAT-6613

185.00€

Máquina pneumática de decapar

Caraterísticas:

- Diâmetro base: 105mm
- Rotações em vazio: 3.500rpm
- Entrada ar: 1/4"
- Dimensões (comp/alt): 203x106mm
- Peso: 960g
- Consumo ar: 280l/min
- Ruído: 98dB



JAT-6613-P

14.50€

Disco de borracha para JAT-6613



JAT-6613-PA

15.50€

Disco abrasivo de limpeza para JAT-6613



JAT-6613-RK

25.00€

Kit de reparação para JAT-6613

JAT-6676

113.00€

Serra pneumática

Caraterísticas:

- Capacidade de corte: 1,6mm (espessura aço)
- Oscilação por minuto: 10 000bpm
- Curso: 10mm
- Comprimento: 235mm
- Peso: 960g
- Interior mangueira: 10mmø



JAT-6676-RK

7.00€

Kit de reparação para JAT-6676

JAT-10T



Serras para JAT-6676 5 unidades

Ref.	Dentes	Compr. (mm)	Preço
JAT-10T18	18	75	12.30€
JAT-10T32	32	75	12.80€

JAT-6421

46.50€

Máquina de corte pneumática de discos com 3"

Caraterísticas:

- Rotações em vazio: 20 000rpm
- Peso: 1 040g
- Interior mangueira: 10mmø



JAT-6421-RK

2.40€

Kit de reparação para JAT-6421

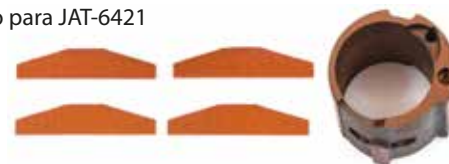

JAT-6421-33

1.40€

Disco de serra para JAT-6421

JAT-6441K
130.00€
Faca pneumática com kit de acessórios

Características:

 Oscilação por minuto: 22 000bpm
 Comprimento: 120mm
 Peso: 1 200g
 Interior mangueira: 10mmø

Acessórios:

 Lâminas: 30; 35 e 57mm
 Mala

JAT-6441-RK
1.50€
Kit de reparação para JAT-6441
CF-K
Lâminas para JAT-6441K

Ref.	Compr. (mm)	Preço
CF-K-C	35	9.50€
CF-K-E	57	7.50€
CF-K-F	90	20.20€
CF-K-G	24	12.70€
CF-K-I	36	15.50€
CF-K-J	63	18.00€

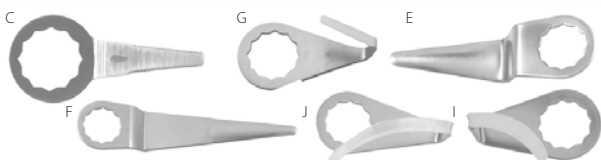
JAT-6952
85.00€
Tesoura pneumática direita

Características:

 Oscilação por minuto: 2 300/ 2 500bpm
 Capacidade de corte: 1,2mm (espessura aço)
 Tamanho do corte: 5,5mm
 Comprimento: 255mm
 Peso: 1 000g
 Interior mangueira: 10mmø

Acessórios:

Lâminas: 30; 35 e 57mm

JAT-6952-RK
1.50€
Kit de reparação para JAT-6952
JAT-6952P
93.00€
Tesoura pneumática

Características:

 Oscilação por minuto: 2 200bpm
 Capacidade de corte: 1,2mm (espessura aço)
 Tamanho do corte: 5,5mm
 Comprimento: 215mm
 Peso: 1 200g
 Interior mangueira: 10mmø

JAT-6952P-RK
1.50€
Kit de reparação para JAT-6952P
JAT-6952P
Lâminas para JAT-6952/P

Ref.	Lâmina	Preço
JAT-6952P-37	esquerda	9.20€
JAT-6952P-39	central	11.70€
JAT-6952P-40	direita	9.20€

JAT-6943A
109.00€
Alicate pneumático de rebaiços

Características:

 Capacidade de corte: 1,4mm
 Capacidade de rebaiço: 8mm
 Quinagem: 12mm
 Comprimento: 248mm
 Peso: 1 300g
 Interior mangueira: 10mmø

JAT-6943A-RK
8.00€
Kit de reparação para JAT-6943A
JAT-6412
64.00€
Reboreadora pneumática

Características:

 Velocidade de corte: 3 200rpm
 Capacidade de corte: 1,4mm (espessura aço)
 Comprimento: 210mm
 Peso: 1 000g
 Interior mangueira: 10mmø

JAT-6412-RK
1.50€
Kit de reparação para JAT-6412

JAH-0288 108.00€

Martelo pneumático de agulhas

Caraterísticas:
 Pancadas por minuto: 5 000
 Número de agulhas: 12
 Comprimento: 290mm
 Peso: 1 200g
 Consumo ar: 90l/min
 Interior mangueira: 10mmø



JAH-0288-15 12.80€

Cinzel para JAH-0288

JAH-0288-16 7.00€

Jogo de agulhas para JAH-0288

JAH-0288-17 5.60€

Alojamento de agulhas para JAH-0288

JAH-0288-RK 23.50€

Kit de reparação para JAH-0288

JAH-6837 143.00€

Martelo burilador direito

Caraterísticas:
 Golpes por minuto: 4 600
 Encaixe: 25,4x43,5
 Comprimento: 380mm
 Peso: 2 100g
 Interior mangueira: 10mmø



JAH-6837-RK 18.50€

Kit de reparação para JAH-6837

JAH-6837-5

Cinzel para JAH-6837

Ref.	Tipo	Compr. (mm)	Preço
JAH-6837-50	plano	35-175	17.00€
JAH-6837-50-2	ponteiro		16.50€

JAH-7104H 326.50€

Martelo pneumático de 1"

Caraterísticas:
 Golpes por minuto: 2 820
 Comprimento: 308mm
 Peso: 5 500g
 Consumo ar: 228l/min
 Interior mangueira: 10mmø



JAH-7104H-RK 5.50€

Kit de reparação para JAH-7104H

JAZ-01

Buril hexagonal

Ref.	Tipo	Preço
JAZ-011H	bico	19.50€
JAZ-016H	ponta	19.50€

JAT-6034 97.00€

Rebitadora pneumática

Caraterísticas:
 Capacidade: 2,4 a 4,8mm (aço+aço inox)
 Potência tração: 10 250Nm
 Curso: 16mm
 Comprimento: 308mm
 Peso: 1 500g
 Interior mangueira: 10mmø



JAT-6034-RK 21.60€

Kit de reparação para JAT-6034



JAT-6034

Bicos para rebitadora JAT-6034

Ref.	Diâmetro (mm)	Preço
JAT-6034-1A	4,8	1.10€
JAT-6034-1B	4	1.10€
JAT-6034-1C	3,2	1.10€
JAT-6034-1D	2	1.10€



JAT-6673 265.00€

Rebitadora pneumática

Caraterísticas:
 Capacidade: 2,4 a 6,4mm (aço+aço inox)
 Curso: 18mm
 Peso: 1 750g
 Consumo ar: 2,9l/ciclo
 Interior mangueira: 10mmø



JAT-6673-RK 53.00€

Kit de reparação para JAT-6673



JAT-1035

395.00€

Rebitadora pneumática de fêmeas

Caraterísticas:

Dimensões: 270x190mm
 Capacidade: M4-M10 (aço)
 Capacidade: M4-M8 (aço inox)
 Curso: 6mm
 Peso: 1 550g
 Consumo ar: 1,5l/ciclo
 Interior mangueira: 10mmø



JAT-1035-RK

6.70€

Kit de reparação para JAT-1035

JAT-460

22.50€

Bomba de massa manual de ponteira rígida

Acionamento por alavanca

Capacidade: 400cc



JAT-480

31.00€

Bomba de massa manual de ponteira flexível

Acionamento por pistoleta

Capacidade: 400cc



JAT-480-NS

8.80€

Ponteira flexível para JAT-480



JAT-6004K

57.00€

Bomba de massa pneumática de ponteira rígida com acessórios

Acionamento por pneumático

Capacidade: 400cc

Acessórios:



Ponteira flexível
 Alavanca por acionamento manual

JAT-501

53.50€

Pistola pneumática para mastique

Caraterísticas:

Entrada: 1/4"
 Capacidade: 310ml
 Pressão: 2,5 a 5,1bar
 Interior mangueira: 10mmø
 Cartucho tipo "Salsichão"



JA-5032

34.50€

Pistola pneumática para mastique

Caraterísticas:

Pressão: 2 a 4bar
 Comprimento: 330mm
 Peso: 1 225g
 Consumo ar: 170l/min
 Interior mangueira: 10mmø metal
 Material: metal



JAZ-3811E

59.00€

Balaceiro

Caraterísticas:

Capacidade de carga: 3 a 5kg
 Comprimento do fio: 1,5mt
 Diâmetro do fio: 3,2mm



JA-3812A

38.00€

Balaceiro

Caraterísticas:

Capacidade de carga: 0,5 a 1,2kg
 Comprimento do fio: 1,6m
 Diâmetro do fio: 1,8mm
 Peso: 560g



JA-3812D

40.00€

Balaceiro

Caraterísticas:

Capacidade de carga: 1 a 2kg
 Comprimento do fio: 1,6m
 Diâmetro do fio: 1,8mm
 Peso: 560g



JAT-6904S

17.00€

Pistolete para água com kit de acessórios com 5 bicos



JAT-6905B

15.00€

Pistolete de ar



JAT-6905S

29.80€

Pistolete de ar com conjunto de acessórios



JAT-6905-C

3.00€

Bico para pistolete de ar
Bico triangular espalmado



JAT-6905-J

10.80€

Bico para pistolete de ar
Bico com escova em nylon



JAT-6959

5.50€

Pistola para ar de bico longo de 1/4"

Comprimento: 100mm
Pressão trabalho: 75-120psi
Ruído: 85-90dba
Fêmea: 1/4"



JAT-6959A

6.80€

Pistola para ar de bico longo de 1/4"

Comprimento: 280mm
Pressão trabalho: 75-120psi
Ruído: 85-90dba
Fêmea: 1/4"



JAZ-000

Enrolador ar

Ref.	Mangueira ø (mm)	Mangueira compr.(m)	Preço
JAZ-0001B	8x12	15	128.00€
JAZ-0002A	8x12	9	96.00€
JAZ-0002B	9,5x13,3	7,5	96.00€
JAZ-0002C	6,5x10	10	94.00€



JAZ-39520

175.00€

Enrolador móvel para ar de 3/8"

Comprimento: 20m
Pressão máxima: 15bar
Peso: 7 000g
Interior mangueira: 9,5mmø
Ligação: 3/8"



JA-725

Mini lubrificador óleo para máquinas pneumáticas

Ref.	Medida	Preço
JA-7253	1/4"	6.70€
JA-7254	3/8"	9.90€



JAZ-0042

14.00€

Cardan para máquinas pneumáticas 1/4"



JAZ-0513

Copo plástico para filtros lubrificadores JAZ-0512/ JAZ-0513

Ref.	Especif.	Preço
JAZ-0513-09	ar	4.40€
JAZ-0513-50	óleo	4.50€



JAZ-0514

Copo plástico para filtros lubrificadores JAZ-0514/ JAZ-0515

Ref.	Especif.	Preço
JAZ-0514-09	ar	6.20€
JAZ-0514-48	óleo	6.20€



JAZ-051

Filtro lubrificador com regulador de pressão



Ref.	Entrada	Fluxo (l/min)	Pressão (bar)	Filtro (µm)	Preço
JAZ-0512	1/4"	1 000	0,5-8,5	5	70.00€
JAZ-0513	3/8"	1 350	0,5-8,5	5	69.50€
JAZ-0514	1/2"	3 000	0,5-8,5	5	102.50€
JAZ-0516	3/4"	3 100	0,5-8,5	5	108.00€

Nota: A pressão máxima de alimentação é de 8.5bar

JAZ-6704A

Filtro lubrificador com regulador de pressão



100.00€

Entrada	Fluxo (l/min)	Pressão (bar)	Filtro (µm)
1/2"	1 250	1-10	5

JAZ-6710A

Filtro de ar 1/2"

39.00€

JAZ-6711A

Regulador de pressão 1/2"

48.50€

JAZ-6712A

Lubrificador de ar 1/2"

38.00€

JAZ-6715A

Filtro de ar com regulador 1/2"

66.00€

JAZ-6704

Copo plástico para filtros lubrificadores JAZ-6704A/ JAZ-6710A

Ref.	Especif.	Preço
JAZ-6704-W	ar	9.30€
JAZ-6704-O	óleo	4.90€

JAZ-7214

Tubo espiral fêmea de 1/4"



Ref.	Medida (mm)	Compr. (m)	Preço
JAZ-7214F	5x8	13	20.00€
JAZ-7214S	6,5x10	13	29.00€
JAZ-7214Z	8x12	15	43.00€

GM-0

Tomada rápida fêmea



Ref.	Medida	Preço
GM-02AF	1/4"	5.70€
GM-03AF	3/8"	6.00€
GM-04AF	1/2"	6.50€

GM-0

Tomada rápida macho



Ref.	Medida	Preço
GM-02AM	1/4"	6.00€
GM-03AM	3/8"	6.10€
GM-04AM	1/2"	6.20€

GM-0

Tomada rápida tubo



Ref.	Medida	Preço
GM-02AH	1/4"	6.40€
GM-03AH	3/8"	6.80€
GM-04AH	1/2"	6.85€
GM-02BH	5/16"	6.80€

Acessórios para redes de ar comprimido

GM-0

Ponteira fêmea

Ref.	Medida	Preço
GM-02PF	1/4"	1.10€
GM-03PF	3/8"	2.10€
GM-04PF	1/2"	2.35€



GM-0

Ponteira macho

Ref.	Medida	Preço
GM-02PM	1/4"	1.10€
GM-03PM	3/8"	2.00€
GM-04PM	1/2"	2.35€



GM-0

Ponteira tubo

Ref.	Medida	Preço
GM-02PH	1/4"	1.25€
GM-03PH	3/8"	1.20€
GM-04PH	1/2"	1.55€
GM-02BPH	5/16"	1.20€



KIT AR

52.00€

Jogo de acessórios de ligação a rede de ar

Composição:

GM-02AF	Tomada rápida fêmea de 1/4"
GM-02PF	Ponteira fêmea de 1/4"
GM-02PM	Ponteira macho de 1/4"
JAT-6905B	Pistolete simples para ar
JAZ-7214S	Tubo espiral 13m





JONNESWAY®

Merchandising



Merchandising

BOUTJW01A-M 7.50€

BOUTJW01A-L 7.50€

BOUTJW01A-XL 7.50€

T-shirt

Com o logotipo da Jonnesway bordado no peito e na manga, nos tamanhos M, L e XL.



BOUTJW02A 5.20€

Boné

Com o logotipo da Jonnesway bordado.



JW-01B 12.50€

Boné

Com o logotipo da Jonnesway bordado.



BOUTJW03A 28.00€

Esferográfica 50 unidades

Com o logotipo da Jonnesway.



BOUTJW04A-M 33.00€

BOUTJW04A-L 33.00€

BOUTJW04A-XL 33.00€

Polar bege

Com o logotipo da Jonnesway bordado no peito, nos tamanhos M, L e XL.



BOUTJW05A 14.50€

Guarda-chuva 1 unidade

Com o logotipo da Jonnesway estampado.



BOUTJW06A 48.00€

Lona Jonnesway

Medidas: 1 480x890mm



BOUTJW07A-M 16.00€

BOUTJW07A-L 16.00€

BOUTJW07A-XL 16.00€

Polo

Com o logotipo da Jonnesway bordado no peito, nos tamanhos M, L e XL.



BOUTJW07B-M 18.50€

BOUTJW07B-L 18.50€

BOUTJW07B-XL 18.50€

Polo

Com o logotipo da Jonnesway bordado no peito, nos tamanhos M, L e XL.



BOUTJW08A-50 44.00€

BOUTJW08A-52 44.00€

BOUTJW08A-54 44.00€

Fato-macaco verde

Com o logotipo da Jonnesway estampado no peito e nas costas.



BOUTJW09A 14.00€

Dispositivo de armazenamento de dados - pen USB 1 unidade
Capacidade: 4 Gb



JW-USB 16.50€

Dispositivo de armazenamento de dados - pen USB 1 unidade
Capacidade: 16 Gb



BOUTJW13A 5.50€

Para-sol

Com o logotipo da Jonnesway.



Merchandising

BOUTJW14A 16.00€

Mochila

Com o logotipo da Jonnesway bordado.

Dimensões: 310x450x120mm



BOUTJW15A 18.30€

Esferográfica "touch" 20 unidades

Com o logotipo da Jonnesway.



BOUTJW16A 2.70€

Porta chaves 1 unidade



BOUTJW17A-1 3.00€

Autocolante Jonnesway

Medidas: 70x400mm



BOUTJW17A-2 8.00€

Autocolante Jonnesway

Medidas: 100x600mm



BOUTJW18A 3.70€

Esferográfica

Com o logotipo da Jonnesway.



BOUTJW19A 32.50€

Esferográfica "roller ball"

Com o logotipo da Jonnesway.



BOUTJW20A-M	19.50€
BOUTJW20A-L	19.50€
BOUTJW20A-XL	19.50€

Sweat shirt

Com o logotipo da Jonnesway bordado no peito, nos tamanhos M, L e XL.



BOUTJW21A-M	56.00€
BOUTJW21A-L	56.00€
BOUTJW21A-XL	56.00€

Colete

Com o logotipo da Jonnesway bordado no peito, nos tamanhos M, L e XL.



BOUTJW22A-M	41.00€
BOUTJW22A-L	41.00€
BOUTJW22A-XL	41.00€

Casaco

Com o logotipo da Jonnesway bordado no peito, nos tamanhos M, L e XL.



BOUTJW23A-M	36.00€
BOUTJW23A-L	36.00€
BOUTJW23A-XL	36.00€

Calças

Com o logotipo da Jonnesway bordado, nos tamanhos M, L e XL.



BOUTJW24A	4.90€
------------------	-------

Bloco de notas A5

Com o logotipo da Jonnesway.

Medidas: 140x210mm



BOUTJW25A	40.00€
------------------	--------

Pasta A4

Com o logotipo da Jonnesway estampado.

Medidas: 260x350x250mm



BOUTJW26A	56.50€
------------------	--------

Mala para portátil

Com o logotipo da Jonnesway estampado.

Medidas: 410x300x80mm



BOUTJW27A	17.50€
------------------	--------

Rato sem fios

Com o logotipo da Jonnesway.



C-DS4

410.00€

Expositor para ferramenta com painéis perfurados e 30 ganchos

Medidas:

Altura: 2 140mm

Profundidade: 660mm

Largura: 940mm



C-DSP

410.00€

Expositor para ferramenta com painéis perfurados e 30 ganchos

Medidas:

Altura: 2 140mm

Profundidade: 660mm

Largura: 940mm



C-DS4-H

1.20€

Gancho para expositor C-DS4

C-DS14

150.00€

Expositor para chaves caixa

Dimensões: 350x420x350mm



FITA JW

3.30€

Fita Jonnesway para embalagem



JW-OPENER

3.30€

Tira cápsulas



AB0	Pag.						
AB010001	154	AB030076-14	160	AE300064-16	122	AE310146B	125
AB010002	154	AB030076-15	160	AE300100-040	122	AE310146D	125
AB010002-A	154	AB030076-17	160	AE300100-042	122	AE310146E	125
AB010017	154	AB030076-18	160	AE300100-060	122	AE310150	124
AB010018	154	AB030076-20	160	AE300103	122	AE310172	125
AB010019	154	AB030076-21	160	AE300149	9	AE310180	125
AB010020	154	AB030076-24	160	AE300152	122	AE310183	125
AB010026S	155	AB030076-26	160	AE300154B	126	AE320023	125
AB010041	155	AB030076-27	160	AE300168	126	AE320034	125
AB010042	155	AB030076-28	160	AE300168-1	126	AE320035	125
AB010043	155	AB030076-30	160	AE300173	123	AE320044	125
AB020002	155	AB030076-32	160	AE300176-A	123	AE330004	157
AB020003	155	AB030076-34	160	AE300201	126	AE330005	157
AB020009	155	AB030089	156	AE300202	126	AE330008	157
AB020010	155	AB030100	156	AE300204	126	AE330009	157
AB020015	155	AC	Pag.	AE300205	126	AE330013	157
AB020019	155	ACC-609	174	AE300206	126	AE330015	157
AB030001	155	AE0	Pag.	AE300207	126	AE330016	157
AB030014	155	AE010015A	8	AE300211	126	AE330030	157
AB030028	155	AE010025A	8	AE300212	123	AE330034	158
AB030041	155	AE020009	6	AE300215	126	AE330035	158
AB030043	155	AE040020	122	AE300220	127	AGO	Pag.
AB030046	155	AE050003	8	AE310002	123	AG010002	91
AB030047	155	AE060002	6	AE310003	157	AG010002SP	34
AB030048	156	AE060003	6	AE310006	123	AG010003	91
AB030056	122	AE070002A	6	AE310008	123	AG010005	91
AB030060	156	AE080001	6	AE310010A	123	AG010006	91
AB030061	122	AE090025	7	AE310013	123	AG010008	91
AB030068A	156	AE090105A	7	AE310014	123	AG010009	91
AB030068C	156	AE110020	7	AE310016	123	AG010011	91
AB030068D	156	AE130003	7	AE310023	124	AG010012	91
AB030068F	156	AE130003-1	7	AE310024	123	AG010023	157
AB030069A	156	AE140013	8	AE310025	123	AG010024	157
AB030069B	156	AE150001	8	AE310026	123	AG010024-1	157
AB030069C	156	AE150002	8	AE310027	123	AG010024-2	157
AB030069E	156	AE150005	122	AE310034	124	AG010026SP	34
AB030070B	156	AE170002	8	AE310035	124	AG010030A	157
AB030070C	156	AE180001	8	AE310037	124	AG010034	127
AB030070D	156	AE2	Pag.	AE310038	124	AG010035	127
AB030071	156	AE200003	9	AE310062	124	AG010036	127
AB030076-00	160	AE3	Pag.	AE310063	124	AG010046	127
AB030076-01	160	AE300025	9	AE310066	124	AG010049	127
AB030076-02	160	AE300064	122	AE310073	124	AG010055	157
AB030076-03	160	AE300064-02	122	AE310077	124	AG010055-B	157
AB030076-05	160	AE300064-03	122	AE310087	124	AG010059	127
AB030076-06	160	AE300064-04	122	AE310099	124	AG010059-10	127
AB030076-07	160	AE300064-05	122	AE310109	125	AG010059-12	127
AB030076-11	160	AE300064-06	122	AE310110	125	AG010059-6	127
AB030076-13	160	AE300064-07	122	AE310112	125	AG010059-8	127
		AE300064-15	122	AE310122	124	AG010089	127

AG010099	127	AI010060-D	130	AI020131	133	AI050080	137
AG010109	128	AI010063A	130	AI020142	133	AI050085A	148
AG010111	127	AI010069	150	AI020154	150	AI050092	138
AG010118A	128	AI010070	150	AI020158	160	AI050093	138
AG010138	158	AI010086	130	AI020162	133	AI050096S	138
AG010138-B	158	AI010092	131	AI020163	133	AI050102	138
AG010140	158	AI010097	147	AI020164	159	AI050104	138
AG010141	158	AI010104	131	AI020178	133	AI050109	138
AG010142	158	AI010107	146	AI020180	133	AI050110	160
AG010143	158	AI010108	151	AI020184	133	AI050113	138
AG010147	128	AI010110	151	AI020184A	133	AI050135	159
AG010150SC	34	AI010114	147	AI020184B	133	AI050152	138
AG010154	7	AI010115	145	AI020184S	133	AI050152A	138
AG010159	127	AI010116	147	AI020185	134	AI050172	159
AG010164	127	AI010121	145	AI020186	148	AI050176	138
AG010168	159	AI010127	131	AI020201	134	AI050191	139
AG010169	159	AI010136	148	AI020205	134	AI050192	139
AG010185	157	AI010137	131	AI030002	135	AI050200	148
AG010204	147	AI010139	145	AI030007	134	AI050201	150
AG010205	142	AI010153	159	AI030010	134	AI050202	138
AG010207	114	AI010166	131	AI030011	134	AI060006	139
AG010208	128	AI010167	131	AI030020	134	AI060020	139
AG010219	7	AI010176	131	AI030025	134	AI060030	139
AG010222	7	AI010195	131	AI030027	134	AI060030-A	139
AG010224	114	AI010201	135	AI030067	137	AI060030-B	139
AG010225	128	AI020015	131	AI040005	135	AI060030-C	139
AG010227	128	AI020019	131	AI040006	135	AI060030-D	139
AG010229	128	AI020020	131	AI040007	134	AI060030-E	139
AG10001SP-G	128	AI020021	131	AI040008	134	AI060030-F	139
AG10001SP-T	128	AI020024	131	AI040011	135	AI060031	139
AG1	Pag.	AI020025	131	AI040017	135	AI060031-A	139
AG10001SP	34	AI020027	131	AI040018	135	AI060031-B	139
AG10001SP-W	129	AI020043	132	AI040031	134	AI060031-C	139
AG10002SC	45	AI020048A	131	AI040060	135	AI060031-D	139
AG10002SC-W	129	AI020048D	131	AI040246	135	AI060031-E	139
AH0	Pag.	AI020048E	131	AI050001	137	AI060031-G	140
AH020002	129	AI020049	132	AI050004	136	AI060031-H	140
AIO	Pag.	AI020051	132	AI050004A	136	AI060031-J	140
AI010006	129	AI020052	132	AI050009A	137	AI1	Pag.
AI010009	129	AI020054	132	AI050022	137	AI10001SP	34
AI010023	129	AI020056A	132	AI050024	137	AI10002SP	34
AI010029	129	AI020066	132	AI050037	137	AI10003SP	35
AI010030	129	AI020092	132	AI050040	137	AL0	Pag.
AI010033	138	AI020101A	132	AI050042	137	AL010006	140
AI010037	129	AI020101A-A	132	AI050043	137	AL010011	140
AI010041	130	AI020103	132	AI050043S	134	AL010029	150
AI010060	130	AI020107	133	AI050071S	145	AL010038	149
AI010060-A	130	AI020109	133	AI050076	137	AL010041	149
AI010060-B	130	AI020113	148	AI050077	137	AL010044	146
AI010060-C	130	AI020127	150	AI050079	150	AL010053A	150

AL010057	148	AN010187	159	AR030062	144	BOUTJW16A	185
AL010070	146	AN010188A	142	AR030067	9	BOUTJW17A-1	185
AL010071	146	AN010188C	142	AR040016	144	BOUTJW17A-2	185
AL010072	151	AN010202	151	AR040043	144	BOUTJW18A	185
AL010087	151	AN010202B	151	AR060002A	144	BOUTJW19A	185
AL010088	151	AN010225	142	AR060003	144	BOUTJW20A-L	186
AL010093	139	AN010226	142	AR060008	144	BOUTJW20A-M	186
AL010099	145	AN010235	159	AR060011	144	BOUTJW20A-XL	186
AL010113	159	AN010237	159	AR060020	144	BOUTJW21A-L	186
AL010114	159	AN010272	142	AR060021	144	BOUTJW21A-M	186
AL010116	159	AN010279	142	AR060024A	144	BOUTJW21A-XL	186
AL010117	159	AN010293	140	AR060029	144	BOUTJW22A-L	186
AL010128	145	AN020006	142	AR060032	144	BOUTJW22A-M	186
AL010175	146	AN020007	142	AR060043	145	BOUTJW22A-XL	186
AL010190	149	AN020007-1	142	AR060055	145	BOUTJW23A-L	186
AL010196	146	AN020022	142	AR060062	141	BOUTJW23A-M	186
AL010202	151	AN020022-A	143	AS	Pag.	BOUTJW23A-XL	186
AL010203	151	AN020022-B	143	AS-0013	174	BOUTJW24A	186
AL010205	147	AN020022-C	143	AS-0013A2	174	BOUTJW25A	186
AL010218	147	AN020022-D	143	AS-0013C	174	BOUTJW26A	186
AL010225	151	AN040035A	143	AS-0015	174	BOUTJW27A	186
AL010282	147	AN040043A	143	AS-0015C	174	C-1	Pag.
ANO	Pag.	AN040055	160	AS-0026	174	C-10DW42	28
AN010001	140	AN040056	160	AS-0065	127	C-13DW53	28
AN010001C	140	AN040062	159	BL	Pag.	C-1DM1	27
AN010001D	140	AN040066	159	BLACK POWER 19	19	C-3	Pag.
AN010009A	137	AN040082	143	BOU	Pag.	C-3DH2	29
AN010030	137	AN040100	149	BOUTJW01A-L	184	C-3DH262	30
AN010033	140	AN040101	143	BOUTJW01A-M	184	C-3DH5	29
AN010038	140	AN040105	159	BOUTJW01A-XL	184	C-3DW5	28
AN010045	124	AN040126	148	BOUTJW02A	184	C-4	Pag.
AN010049	140	AN040168	143	BOUTJW03A	184	C-4DWA1	27
AN010054A	141	AN040200	159	BOUTJW04A-L	184	C-4DWA1G	27
AN010054N	141	AN040286	147	BOUTJW04A-M	184	C-5	Pag.
AN010063	140	AN1	Pag.	BOUTJW04A-XL	184	C-5CD	29
AN010065	141	AN100002SP	35	BOUTJW05A	184	C-6	Pag.
AN010066	141	ARO	Pag.	BOUTJW06A	184	C-6DA4	29
AN010068	141	AR020016	9	BOUTJW07A-L	184	C-6DA494	29
AN010072	141	AR020018	143	BOUTJW07A-M	184	C-6DWB1	27
AN010072C	141	AR020019	143	BOUTJW07A-XL	184	C-6DWB1G	27
AN010081A	141	AR020053A	143	BOUTJW07B-L	184	C-6DWB5	27
AN010085A	140	AR020060	9	BOUTJW07B-M	184	C-7	Pag.
AN010091A	141	AR020061	9	BOUTJW07B-XL	184	C-7DB2	27
AN010092	141	AR030013	143	BOUTJW08A-50	185	C-7DB2B	27
AN010106A	141	AR030022	160	BOUTJW08A-52	185	C-7DS1	28
AN010112	141	AR030024	160	BOUTJW08A-54	185	C-7DW1-TS	30
AN010131	141	AR030034	143	BOUTJW09A	185	C-7DW9	28
AN010137	141	AR030041	143	BOUTJW13A	185	C-7 TOWER	28
AN010177B	144	AR030047	144	BOUTJW14A	185	C-A	Pag.
AN010186B	142	AR030058	95	BOUTJW15A	185	C-A10	31

C-A11	31	C-SQ3402	25	D10M75M10A	104	D150H030A	104
C-A12	31	C-SQ3403	25	D10M75M12A	104	D150H040A	104
C-A13	31	C-SR3401	26	D10M75M14A	104	D150H050A	104
C-A16W	28	C-SU01	26	D150MH1AD	105	D150H060B	104
C-A17W	28	C-SU02	26	D150MH1QD	105	D150H070B	104
C-A2501S	31	C-SW01	26	D165MN06M	105	D150H080B	104
C-A27	30	C-SW02	26	D165MN07M	105	D150MH1AD	105
C-A3	30	C-T	Pag.	D165MN08M	105	D150MH1QD	105
C-A3-B	30	C-T3	29	D165MN10M	105	D150P1A	104
C-A31	30	C-T4A	10	D165MN12M	105	D150P2A	104
C-A3G	30	C-T5G-DP	10	D165MN13M	105	D150P3A	104
C-A456	30	C-T12	29	D12	Pag.	D150T20A	105
C-A7	31	C-W	Pag.	D125H015A	104	D150T25A	105
C-A8	31	C-WHEEL1	31	D125H020A	104	D150T27A	105
C-A9	30	C-WHEEL2	31	D125H025A	104	D150T30A	105
C-APB	31	C-WHEEL5	31	D125H030A	104	D150T40A	105
C-B	Pag.	C-WHEEL6	31	D125H040A	104	D150Z1A	104
C-BS Kit1	31	C-WHEEL8	31	D125H050A	104	D150Z2A	104
C-BS Kit2	31	C-WHEEL9	31	D125H060A	104	D150Z3A	104
C-BS Kit3	31	CF	Pag.	D125P1F	104	D16	Pag.
C-D	Pag.	CF-K-C	177	D125P2F	104	D165MN06M	105
C-DBU1	10	CF-K-E	177	D125T10A	105	D165MN07M	105
C-DBU7	10	CF-K-F	177	D125T15A	105	D165MN08M	105
C-DM1	114	CF-K-G	177	D125T20A	105	D165MN10M	105
C-DMH212	79	CF-K-I	177	D125T25A	105	D165MN12M	105
C-DMH314	79	CF-K-J	177	D125T27A	105	D165MN13M	105
C-DMH414	79	CH	Pag.	D125T30A	105	D17	Pag.
C-DSP	187	CHAPEIRO20-BLACK	20	D125T40A	105	D175H100	104
C-DS14	187	CHAPEIRO20-C	20	D125Z1A	104	D175H120	104
C-DS4	187	CHAPEIRO20-GREEN	20	D125Z2A	104	D175H40	104
C-DS4-H	187	CHAPEIRO20-V	20	D125Z3A	104	D175H50	104
C-H	Pag.	CHAPEIROALU-BLACK	21	D13	Pag.	D175H60	104
C-HA	29	CHAPEIROALU-C	21	D130H100	104	D175H70	104
C-HA78S	29	CHAPEIROALU-GREEN	21	D130H120	104	D175H80	104
C-P	Pag.	CHAPEIROALU-V	21	D130H40	104	D175T20	105
C-PC1	31	D10	Pag.	D130H50	104	D175T25	105
C-PC2	31	D100MN08M	105	D130H60	104	D175T30	105
C-PC3	31	D100MN10M	105	D130H70	104	D175T40	105
C-S	Pag.	D100MN12M	105	D130H80	104	D175T45	105
C-S7DW1	25	D100MN13M	105	D130T20	105	D175T50	105
C-SA2	24	D100MN14M	105	D130T25	105	D175T55	105
C-SA2S	24	D10M30M05A	104	D130T30	105	D37	Pag.
C-SA3	24	D10M30M06A	104	D130T40	105	D3750P08S	102
C-SA3S	24	D10M30M08A	104	D130T45	105	D3750T08S	102
C-SA4S	25	D10M30M10A	104	D130T50	105	D3750T18S	102
C-SInox	26	D10M30M12A	104	D130T55	105	D376514SC	45
C-SM	26	D10M30M14A	104	D15	Pag.	D70	Pag.
C-SP3401	25	D10M75M05A	104	D150F5510A	104	D70105KV	42
C-SQ2401	25	D10M75M06A	104	D150F6512A	104	D70105SP	35
C-SQ3401	25	D10M75M08A	104	D150F8012A	104	D70P175	92

D70P2100	98	D71S4100	99	D725N11	100	F	Pag.
D70P3125	98	D71S4150	99	D725N12	100	FITA JW	187
D70P3150	98	D71S4150	99	D725N13	100	GM	Pag.
D70PP07S	98	D71S4200	99	D73	Pag.	GM-02AF	181
D70PP10S	98	D71S480	99	D737128SV	40	GM-02AH	181
D70S475	98	D71S5125	99	D737134SV	40	GM-02AM	181
D70S5100	98	D71S5200	99	DBT	Pag.	GM-02BH	181
D70S6125	98	D71S5300	99	DBT31B	103	GM-02BPH	182
D70S6150	98	D71S538	99	DR0	Pag.	GM-02PF	182
D70S8150	98	D71S575	99	DR0107S	102	GM-02PH	182
D70S8175	98	D71S6100	99	DR0253S	102	GM-02PM	182
D70S9175	98	D71S6150	99	DV1	Pag.	GM-03AF	181
D70S9250	98	D71S638	99	DV13P060	115	GM-03AH	181
D71	Pag.	D71S6400	99	DV13P180	115	GM-03AM	181
D71157SV	40	D71S8150	99	DV13P2100	115	GM-03PF	182
D71400T10	100	D71S8200	99	DV13P3150	115	GM-03PH	182
D71400T15	100	D71S8300	99	DV13PP-TP	98	GM-03PM	182
D71400T20	100	D71S8500	99	DV13PP07S	115	GM-04AF	181
D71400T25	100	D71S9175	99	DV13S275	115	GM-04AH	181
D71400T30	100	D71T10	100	DV13S3100	115	GM-04AM	181
D715N05	101	D71T107S	101	DV13S4100	115	GM-04PF	182
D715N07	101	D71T109S	101	DV13S5125	115	GM-04PH	182
D715N08	101	D71T15	100	DV13S6150	115	GM-04PM	182
D715N10	101	D71T20	100	DV13S8175	115	GR	Pag.
D715N12	101	D71T25	100	DV13Z060	115	GREEN POWER	119
D715N13	101	D71T27	100	DV13Z180	115	H01	Pag.
D71C105S	101	D71T30	100	DV13Z2100	115	H01B1015	106
D71C106S	101	D71T40	100	DV13Z3150	115	H01B1020	106
D71P060	99	D71T45	100	DV4	Pag.	H01B1025	106
D71P1100	99	D71T5	100	DV4118SV	115	H01B1030	106
D71P1150	99	D71T50	100	DV41M06S	116	H01B1035	106
D71P1300	99	D71T6	100	DV41M10	115	H01B1040	106
D71P138	99	D71T7	100	DV41M13	115	H01B1045	106
D71P180	99	D71T8	100	DV41M5	115	H01B1050	106
D71P2100	99	D71T9	100	DV41M6	115	H01B1055	106
D71P2150	99	D71Z060	100	DV41M7	115	H01B1060	106
D71P2250	99	D71Z105S	101	DV41M8	115	H01B1070	106
D71P238	99	D71Z107S	102	E	Pag.	H01B1080	106
D71P2400	99	D71Z138	100	ELECTR-BLACK	19	H01B1090	106
D71P3150	99	D71Z180	100	ELECTR-C	19	H01B1100	106
D71P3250	99	D71Z2100	100	ELECTR-GREEN	19	H01B1120	106
D71P3400	99	D71Z3150	100	ELECTR-V	19	H01B1140	106
D71P4200	99	D71Z4200	100	ELECTR. 1000 BLACK	17	H01B1170	106
D71PP08KV	42	D72	Pag.	ELECTR. 1000 GREEN	17	H01B1190	106
D71PP08S	101	D725N06	100	ELECTR. 1000-C	17	H01B1220	106
D71PP08SP	35	D725N07	100	ELECTR. 1000-V	17	H01MH118S	106
D71PP16S	101	D725N08	100	EVA POWER BLACK	13	H01SA109S	106
D71S10250	99	D725N08SP	35	EVA POWER GREEN	13	H01SA1100	106
D71S250	99	D725N09	100	EVA POWER-C	13	H01SA115	106
D71S360	99	D725N10	100	EVA POWER-V	13	H01SA120	106

H01SA125	106	H08ST27145	108	H20MT20	109	JA-3808A	174
H01SA130	106	H08ST30165	108	H20MT25	109	JA-3812A	179
H01SA140	106	H08ST40185	108	H20MT27	109	JA-3812D	179
H01SA150	106	H08ST45205	108	H20MT30	109	JA-5032	179
H01SA160	106	H08ST50230	108	H20MT40	109	JA-6111(1.4)	173
H01SA180	106	H10	Pag.	H20MT45	109	JA-6111-NS13	173
H01SM109S	106	H10121SV	40	H20MT50	109	JA-6111-NS17	173
H02	Pag.	H10MB08KV	42	H22	Pag.	JA-6111-NS20	173
H02MH217S	106	H10MB08S	108	H22S109S	109	JA-6111K	173
H02SM109S	106	H10MB08SP	35	HC	Pag.	JA-7253	180
H02SM209S	106	H10MB10200	108	HC-100/15	136	JA-7254	180
H03	Pag.	H10MB2100	108	HC-106/15	136	JA-950	175
H03MH118S	106	H10MB25100	108	HC-108/15	136	JA-950-04	175
H03SM109S	107	H10MB3100	108	HC-108/18	136	JA-960	175
H05	Pag.	H10MB4100	108	HC-65/14	136	JA-C131SV	40
H05SA109S	107	H10MB5150	108	HC-65/67	136	JA-HVLP-1080GK	173
H05SS109S	107	H10MB6150	108	HC-65103	136	JA-HVLP-3000-NS17	173
H06	Pag.	H10MB8200	108	HC-66/6	136	JA-HVLP-3000-NS19	173
H06MT109S	107	H10MT08KV	42	HC-68/14	136	JA-HVLP-300C (1.3)	173
H06SA109S	107	H10MT08SP	35	HC-73/14	136	JA-HVLP-6112	174
H06SA1100	107	H10MT09S	108	HC-74/15	136	JA-LVLP-0303W	174
H06SA115	107	H10MT10100	108	HC-74/76	136	JA-LVLP-0303W-N	174
H06SA120	107	H10MT15100	108	HC-75/77	136	JA-LVLP-0303W-N18	174
H06SA125	107	H10MT20100	108	HC-76/12	136	JAB	Pag.
H06SA130	107	H10MT25100	108	HC-76/14	136	JAB-1017	168
H06SA140	107	H10MT27150	108	HC-76/30	136	JAB-1017-RK	168
H06SA150	107	H10MT30150	108	HC-76/8	136	JAB-1018	168
H06SA160	107	H10MT40150	108	HC-78/15	136	JAB-1018-RK	168
H06SA180	107	H10MT45200	108	HC-80/15	136	JAB-7003A	168
H06SM209S	107	H10MT50200	108	HC-80/82	136	JAB-7003A-RK	168
H06W106S	109	H12	Pag.	HC-86/16	136	JAD	Pag.
H07	Pag.	H12S09085	109	HC-86/18	136	JAD-0413	167
H07M09S	107	H12S10090	109	HC-9.5mm	136	JAD-0413-RK	167
H07MT10	107	H12S110S	108	HC-90/15	136	JAD-1015-RK	168
H07MT15	107	H12S15100	109	HC-92/10	136	JAD-1015K	168
H07MT20	107	H12S20115	109	HC-93/15	136	JAD-1020	167
H07MT25	107	H12S25130	109	HC-93/36	136	JAD-1020-RK	167
H07MT27	107	H12S27145	109	HC-93/45	136	JAD-1021	167
H07MT30	107	H12S30165	109	HC-95/15	136	JAD-1021-RK	167
H07MT40	107	H12S40185	109	HC-96/18	136	JAD-1027	167
H07MT45	107	H12S45205	109	HV	Pag.	JAD-1027-RK	167
H07MT50	107	H12S50230	109	HV1000V-BLACK	18	JAD-6252A	168
H08	Pag.	H15	Pag.	HV1000V-C	18	JAD-6252A-RK	168
H08MTP09S	107	H15M105S	108	HV1000V-GREEN	18	JAG	Pag.
H08S110S	108	H20	Pag.	HV1000V-V	18	JAG-0903-MS	168
H08ST09085	108	H20MB1037S	109	JA	Pag.	JAG-0906R/RM-RK	159
H08ST10090	108	H20MT08SP	35	JA-0001RK	174	JAG-0906RMK	159
H08ST15100	108	H20MT09S	109	JA-300C-28	174	JAG-0913RM-RK	169
H08ST20115	108	H20MT10	109	JA-300C-NS13	173	JAG-0913RMK	169
H08ST25130	108	H20MT15	109	JA-3806C	174	JAG-0923RM	169

JAG-0923RM-RK	169	JAI-1513-RK	163	JAS-6535-5HE	172	JAT-6613	176
JAG-0925RM	169	JAI-1514	163	JAS-6535-5HE-47	173	JAT-6613-P	176
JAG-0925RM-RK	169	JAI-1514-RK	163	JAS-6535-5HE-RK	172	JAT-6613-PA	176
JAG-0955RM	169	JAI-6202-RK	163	JAS-6535-5VE-RK	173	JAT-6613-RK	176
JAG-0955RM-RK	169	JAI-6202K	163	JAS-6535-6HE	173	JAT-6673	178
JAG-1087	170	JAI-6211	164	JAS-6535-6HE-RK	173	JAT-6673-RK	178
JAG-1087-RK	170	JAI-6211-RK	164	JAS-6542	175	JAT-6676	176
JAG-6638	170	JAI-6212-RK	164	JAS-6542-RK	175	JAT-6676-RK	176
JAG-6638-RK	170	JAI-6212K	164	JAS-6543	175	JAT-6904S	180
JAG-6639	170	JAR	Pag.	JAS-6543-RK	175	JAT-6905-C	180
JAG-6639-RK	170	JAR-1012	166	JAS-6551	170	JAT-6905-J	180
JAH	Pag.	JAR-1012-RK	166	JAS-6551-RK	170	JAT-6905B	180
JAH-0288	178	JAR-1013	166	JAS-6552	170	JAT-6905S	180
JAH-0288-15	178	JAR-1013-RK	166	JAS-6552-RK	170	JAT-6943A	177
JAH-0288-16	178	JAR-1033	167	JAT	Pag.	JAT-6943A-RK	177
JAH-0288-17	178	JAR-1033-RK	167	JAT-1011	176	JAT-6952	177
JAH-0288-RK	178	JAR-1094	166	JAT-1011-RK	176	AT-6952-P	177
JAH-6837	178	JAR-1094-RK	166	JAT-1020-RK	175	JAT-6952-RK	177
JAH-6837-50	178	JAR-6309A-RK	166	JAT-1020K	175	JAT-6952P-37	177
JAH-6837-50-2	178	JAR-6309AK	166	JAT-1035	179	JAT-6952P-39	177
JAH-6837-RK	178	JAR-6310A	166	JAT-1035-RK	179	JAT-6952P-40	177
JAH-7104H	178	JAR-6310A-RK	166	JAT-1041	176	JAT-6952P-RK	177
JAH-7104H-RK	178	JAR-6310AK	167	JAT-1041-16S	176	JAT-6959	180
JAI	Pag.	JAS	Pag.	JAT-10T18	176	JAT-6959A	180
JAI-0501-RK	163	JAS-0010	171	JAT-10T32	176	JAZ	Pag.
JAI-0501K	163	JAS-0010-41	171	JAT-12F1	175	JAZ-0001B	180
JAI-0926-RK	164	JAS-0010-RK	171	JAT-12F2	175	JAZ-0002A	180
JAI-0936	164	JAS-0413	171	JAT-12F3	175	JAZ-0002B	180
JAI-0936-RK	164	JAS-0413-RK	171	JAT-12F4	175	JAZ-0002C	180
JAI-0938	165	JAS-0423-RK	171	JAT-20T14	175	JAZ-0042	180
JAI-0938-RK	165	JAS-0423K	171	JAT-20T18	175	JAZ-011H	178
JAI-1024	162	JAS-0452	175	JAT-20T24	175	JAZ-016H	178
JAI-1024-RK	162	JAS-0452-RK	175	JAT-460	179	JAZ-0512	181
JAI-1054	163	JAS-1021-6HE(2.5)	171	JAT-480	179	JAZ-0513	181
JAI-1054-RK	163	JAS-1021-6HE-RK	171	JAT-480-NS	179	JAZ-0513-09	180
JAI-1114	162	JAS-1031-6HE	172	JAT-501	179	JAZ-0513-50	180
JAI-1114-RK	162	JAS-1031-6HE-RK	172	JAT-6004K	179	JAZ-0514-09	180
JAI-1124	162	JAS-1031-6HP	172	JAT-6034	178	JAZ-0514-48	180
JAI-1124-RK	162	JAS-1031-6VE-RK	172	JAT-6034-1A	178	JAZ-0516	181
JAI-1138	165	JAS-1206-6HE	171	JAT-6034-1B	178	JAZ-3811E	179
JAI-1138-RK	165	JAS-1206-6HE-RK	171	JAT-6034-1C	178	JAZ-39520	180
JAI-1138L	165	JAS-1206-6HP	172	JAT-6034-1D	178	JAZ-6704-O	181
JAI-1206L	165	JAS-1207-6HE	172	JAT-6034-RK	178	JAZ-6704-W	181
JAI-1206L-RK	165	JAS-1207-6HE-56	172	JAT-6412	177	JAZ-6704A	181
JAI-1232-RK	162	JAS-1207-6HE-57	172	JAT-6412-RK	177	JAZ-6710A	181
JAI-1232K	162	JAS-1207-6HE-RK	172	JAT-6421	176	JAZ-6711A	181
JAI-1408	165	JAS-6505	170	JAT-6421-33	176	JAZ-6712A	181
JAI-1408-RK	165	JAS-6505-RK	170	JAT-6421-RK	176	JAZ-6715A	181
JAI-1408L	166	JAS-6531	172	JAT-6441-RK	177	JAZ-7207	196
JAI-1513	163	JAS-6531-RK	172	JAT-6441K	177	JAZ-7214F	181

JAZ-7214S	181	M2940-T2	110	ME010010	152	MI010017	153
JAZ-7214Z	181	M60	Pag.	ME010012	152	MI010018	153
JW	Pag.	M60103	111	ME020001	152	MI010019	153
JW-01B	184	M60104	111	ME020002	152	MI010020	153
JW-USB	185	M60105	111	ME020003	152	MI010021	153
JW-OPENER	187	M61	Pag.	ME020005	152	MI020001	153
KIT	Pag.	M61110	111	ME020006	152	MI020002	153
KIT AR	182	M61112	111	MEC	Pag.	MI020004	153
M03	Pag.	M61113	111	MEC PESADOS 20A	23	MK2	Pag.
M03025	1110	M61116	111	MEC PESADOS 20B	23	MK2040	113
M04	Pag.	M61119	111	MEC POWER 19C	15	MK2040-B	113
M04008	110	M61122	111	MEC POWER 19V	15	MK2080	113
M04012	110	M61125	111	MEC PROF-GREEN	16	MKS	Pag.
M04016	110	M61H116	112	MEC PROF-BLACK	16	MKS27	113
M04024	110	M61H119	112	MEC PROF-C	16	MKS27-12	113
M04032	110	M61H124	112	MEC PROF-V	16	MKS27-16	113
M05	Pag.	M62	Pag.	MEC SOLUTION-BLACK	14	MKS27-16A	113
M05020	110	M62102	111	MEC SOLUTION-C	14	MKS27-20	113
M06	Pag.	M62103	111	MEC SOLUTION-GREEN	14	MKV	Pag.
M06030	110	M62104	111	MEC SOLUTION-V	14	MKV7	116
M06040	110	M62105	111	MF0	Pag.	MKV7-K	116
M07	Pag.	M62106	111	MF05A	112	MKV8	116
M07016	110	M62108	111	MF05B	112	MN	Pag.
M07016-ACE	110	M62H102	112	MF05C	112	MN020004	153
M07016-TPR	110	M62H103	112	MF05D	112	MN020005	154
M09	Pag.	M62H104	112	MF05E	112	MS	Pag.
M09100	110	M62H106	112	MF05S	112	MSH1214	79
M091000	110	M63	Pag.	MFM	Pag.	MSH1414	79
M09103KV	43	M63102	111	MFM06S	112	MSH3814	79
M09200	110	M63103	111	MG0	Pag.	MT0	Pag.
M09300	110	M63104	111	MG010001	152	MT010001	154
M09500	110	M63105	111	MG010002	152	MT010002	154
M09513SP	36	M63106	111	MG010003	152	MT010003	154
M09800	110	M63106S	112	MG010004	152	MT010004	154
M10	Pag.	M63108	111	MG010005	152	MT010005	154
M10110	156	M63113KV	43	MG010006	152	MT010006	154
M10210A	156	M63H103	112	MG010008	152	MT010007	154
M10210B	156	M63H105	112	MG010009	152	MT010008	154
M10410A	156	M63H106	112	MG020001	153	MT0701	113
M10410B	156	M63H108	112	MG020003	153	MT0702	113
M11	Pag.	M63M106S	112	MG020004	153	MT0703	113
M11035	110	M64	Pag.	MG020006	153	MTC	Pag.
M11045	110	M64105	111	MG020007	153	MTC101SP	36
M11065	110	M64105S	112	MG020008	153	MTC1150	113
M29	Pag.	M645114SP	36	MH	Pag.	MTC1200	113
M2927	110	M64M105S	112	MHS08KV	43	MTC1300	113
M2927-T1	110	ME0	Pag.	MHS100AG	112	MTC153	113
M2927-T2	110	ME010001	152	MI0	Pag.	MTC156	113
M2940	110	ME010007	152	MI010014	153	MTC200	113
M2940-T1	110	ME010009	152	MI010016	153	MTC306	113

MTC308	113	P15	Pag.	P43	Pag.	P81	Pag.
MTC408	113	P1516	93	P4318	94	P8106	92
MTC508	113	P15808	94	P4318-RK	94	P82	Pag.
MTM	Pag.	P17	Pag.	P4330	94	P82714SV	40
MTM1025	114	P178	94	P4330-RK	94	P82736SV	40
MTM1050	114	P18	Pag.	P52	Pag.	P86	Pag.
MTM1075	114	P1810	94	P52A10	96	P8606	92
MTM1100	114	P20	Pag.	P52B10	96	P90	Pag.
P01	Pag.	P2010LA	94	P52C10	96	P9006	92
P011804KV	43	P2010RA	94	P52D12	96	P94	Pag.
P018	91	P2010SA	94	P52M10	96	P9409	96
P018SP	36	P22	Pag.	P52N10	96	P95	Pag.
P018SP1	36	P2205E	94	P53	Pag.	P9506	91
P03	Pag.	P2208A	94	P53M06	96	P9508C	92
P038	91	P2212A	94	P53M11	96	P9508D	92
P04	Pag.	P266	91	P53M18	96	P96	Pag.
P046	91	P27	Pag.	P54	Pag.	P9601	112
P04704SP	36	P2706	91	P54M08A	96	P99	Pag.
P05	Pag.	P2710	91	P54M10A	96	P9902S	92
P0516	93	P2710SP	36	P60	Pag.	P-B	Pag.
P0518	93	P2712	91	P6008	91	P-B (31)	48
P06	Pag.	P28	Pag.	P61	Pag.	P-B (41)	48
P068	91	P2803SP	37	P6106	91	P-EVA	Pag.
P068A	91	P2810	91	P6108	91	P-EVA(D71PP08KV)	46
P07	Pag.	P28110	93	P6116	93	P-EVA(D737128SV)	46
P079	91	P28112	93	P64	Pag.	P-EVA(D737134SV)	46
P08	Pag.	P28210	93	P6424	94	P-EVA(H10121SV)	46
P0803SP	36	P28212	93	P71	Pag.	P-EVA(H10MB08KV)	46
P0813SC	45	P30	Pag.	P7101	92	P-EVA(H10MT08KV)	46
P0816	93	P30M07C	97	P7102	92	P-EVA(M09103KV)	46
P0817	93	P30M10A	96	P7103	92	P-EVA(M63113KV)	46
P0818	93	P32	Pag.	P7104	92	P-EVA(MHS08KV)	46
P09	Pag.	P32M03S	97	P7105	92	P-EVA(P011804KV)	46
P0903SP	36	P32M05C	97	P76	Pag.	P-EVA(P32M105KV)	46
P0916	93	P32M07A	96	P7601	94	P-EVA(P82714SV)	46
P0917	93	P32M105KV	43	P7602	94	P-EVA(P82736SV)	46
P0918	93	P32M10A	96	P7603	94	P-EVA(S03A4122KV)	47
P10	Pag.	P32M10C	97	P7608	94	P-EVA(S04H2132KV)	47
P1016	93	P36	Pag.	P77	Pag.	P-EVA(S04H4144KV)	47
P1017	93	P36M06C	97	P7719	94	P-EVA(S04H42165SV)	47
P1019	96	P36M09A	96	P78	Pag.	P-EVA(S04H4295SV)	47
P11	Pag.	P36M09C	97	P7801	97	P-EVA(S04H45121SV)	47
P1116	93	P37	Pag.	P7802	97	P-EVA(S29H4141KV)	47
P1118	93	P37M11A	96	P7803	97	P-EVA(W23559SV)	47
P12	Pag.	P37M18A	96	P7804	97	P-EVA(W25110KV)	47
P1216	93	P38	Pag.	P7805	97	P-EVA(W26116KV)	47
P1218	93	P38M09A	96	P78M10C	97	P-EVA(W26134SV)	47
P14	Pag.	P38M11A	96	P80	Pag.	P-EVA(W2623431SV)	47
P1416	93	P40	Pag.	P8006	92	PI	Pag.
		P4016	93			PINTOR20-BLACK	22

PINTOR20-C	22	PV1218	116	R41	Pag.	S01U4117	82
PINTOR20-GREEN	22	PV1416	116	R4103	51	S01U4119	82
PINTOR20-V	22	PV1516	116	R4104	51	S01U4121	82
PO	Pag.	PV4	Pag.	R45	Pag.	S01U4122	82
POWER LINE	15	PV4006	117	R4502	51	S03	Pag.
PSV	Pag.	R12	Pag.	R4502JRK	52	S03A2110	83
PSV108SP	117	R1206N	50	R4502RK	52	S03A2112	83
PSV110SC	117	R1206R	52	R48	Pag.	S03A2114	83
P-TR	Pag.	R12081	52	R4802A	51	S03A4109	83
P-TR (D70SP06ST)	48	R12081RK	52	R4802RK	52	S03A4110	83
P-TR (PC303ST)	48	R19	Pag.	R4804A	51	S03A4111	83
P-TR (S04H4120ST)	48	R19H310S	82	R4804B	51	S03A4111S	82
P-TR (S04H4506ST)	48	R19H3110	82	R4804RK	52	S03A4112	83
P-TR (W26107ST)	48	R19H3111	82	R4811SC	45	S03A4113	83
P-TR (W26920ST)	48	R19H3112	82	R51	Pag.	S03A4114	83
P-TR(AG010002SP)	48	R19H3113	82	R5104	51	S03A4115	83
P-TR(AG010026SP)	48	R19H3114	82	R5104RK	51	S03A4116	83
P-TR(AI10002SP)	48	R19H3115	82	R53	Pag.	S03A4117	83
P-TR(D70105SP)	48	R19H3116	82	R53A-3A	82	S03A4118	83
P-TR(D71PP08ST)	48	R19H3117	82	R53A-4A	82	S03A4119	83
P-TR(H10MB08SP)	48	R19H3118	82	R58	Pag.	S03A4121	83
P-TR(M09513SP)	48	R19H3119	82	R5802ERK	52	S03A4122	83
P-TR(M645114SP)	48	R2	Pag.	R5803RK	52	S03A4122KV	43
P-TR(P04704SP)	48	R2902	50	R5804ERK	52	S03A4122SP	37
P-TR(P0803SP)	48	R2902RK	52	R5804LRK	52	S03A4123	83
P-TR(P0903SP)	48	R2903RK	52	R66	Pag.	S03A4124	83
P-TR(S03A4122SP)	48	R2904	50	R6602	52	S03A4127	83
P-TR(S04H2125SP)	48	R2904RK	52	R6603	52	S03A4129	83
P-TR(S04H3157SP)	48	R34	Pag.	R6604	52	S03A4130	83
P-TR(S04H3536SP)	48	R3402RK	52	R68	Pag.	S03A4132	83
P-TR(S04H4125SP)	48	R3403	51	R6802	52	S03A4211S	84
P-TR(S04H4524SP)	48	R3403RK	52	R6802RK	52	S03A4A3	84
P-TR(S04H4726SP)	48	R3404RK	52	R6803	52	S03A4A6	84
P-TR(S04H4728SP)	48	R35	Pag.	R6803RK	52	S03A4E4	84
P-TR(S06H427SP)	48	R3502	51	R6804	52	S03A4E5	84
P-TR(S09H4118SP)	48	R3503	51	R6804RK	52	S03A4E6	84
P-TR(S29H4140SP)	48	R3504	51	RD0	Pag.	S03A4E8	84
P-TR(W23108SP)	48	R36	Pag.	RD01	52	S03A4U4	84
P-TR(W25110SP)	48	R3602	51	RD01032S	103	S03A4UT3S	84
P-TR(W26112SP)	48	R3602RK	52	RD02	52	S03A6108S	85
P-TR(W26116SP)	48	R3603	51	RV0	Pag.	S03A6126	85
PV0	Pag.	R3603RK	52	RV032	119	S03A6127	85
PV0118	116	R3604RK	52	RV033	119	S03A6129	85
PV0518	116	R37	Pag.	RV034	119	S03A6130	85
PV0816	116	R3702	51	S01	Pag.	S03A6132	85
PV0817	116	R3702B	51	S01U4108S	83	S03A6133	85
PV1	Pag.	R3703	51	S01U4113	82	S03A6134	85
PV1016	116	R3704	51	S01U4114	82	S03A6135	85
PV1116	116	R3704B	51	S01U4115	82	S03A6136	85
PV1118	116			S01U4116	82	S03A6137	85

S03A6138	85	S03A8160	87	S03AD6129	86	S03V3112	117
S03A6139	85	S03A8165	87	S03AD6130	86	S03V3113	117
S03A6140	85	S03A8170	87	S03AD6132	86	S03V3114	117
S03A6141	85	S03A8173	87	S03AD6133	86	S03V3116SC	117
S03A6142	85	S03A8175	87	S03AD6134	86	S03V3117	117
S03A6143	85	S03A8176	87	S03AD6135	86	S03V3119	117
S03A6144	85	S03A8178	87	S03AD6136	86	S03V3122	117
S03A6145	85	S03A8180	87	S03AD6138	86	S03V3136SV	118
S03A6146	85	S03A8185	87	S03AD6140	86	S03V4110	117
S03A6147	85	S03A8189	87	S03AD6141	86	S03V4111	117
S03A6148	85	S03A8190	87	S03AD6142	86	S03V4112	117
S03A6149	85	S03A8192	87	S03AD6144	86	S03V4113	117
S03A6150	85	S03A8195	87	S03AD6146	86	S03V4114	117
S03A6151	85	S03A8A6	87	S03AD6150	86	S03V4117	117
S03A6152	85	S03A8E04	87	S03AD8107S	87	S03V4119	117
S03A6153	85	S03A8E07	87	S03AD8117	88	S03V4120SC	118
S03A6154	85	S03A8E10	87	S03AD8124	88	S03V4122	117
S03A6155	85	S03AD4110	83	S03AD8126	88	S03V4124	117
S03A6156	85	S03AD4111	83	S03AD8127	88	S03V4124SV	118
S03A6157	85	S03AD4111S	84	S03AD8129	88	S03V4127	117
S03A6158	85	S03AD4112	83	S03AD8130	88	S03V4132	117
S03A6159	85	S03AD4113	83	S03AD8132	88	S04	Pag.
S03A6160	85	S03AD4114	83	S03AD8133	88	S04H2104	67
S03A6163	85	S03AD4115	83	S03AD8134	88	S04H21045	67
S03A6165	85	S03AD4116	83	S03AD8135	88	S04H2105	67
S03A6167	85	S03AD4117	83	S03AD8136	88	S04H21055	67
S03A6170	85	S03AD4118	83	S03AD8138	88	S04H2106	67
S03A6A4	86	S03AD4119	83	S03AD8140	88	S04H2107	67
S03A6A8	86	S03AD4121	83	S03AD8141	88	S04H2108	67
S03A6E04	86	S03AD4122	83	S03AD8142	88	S04H2109	67
S03A6E08	86	S03AD4124	83	S03AD8146	88	S04H2110	67
S03A6E10	86	S03AD4126	83	S03AD8148	88	S04H2111	67
S03A6U6	86	S03AD4127	83	S03AD8150	88	S04H2112	67
S03A8109S	87	S03AD4128	83	S03AD8155	88	S04H2113	67
S03A8124	87	S03AD4130	83	S03AD8158	88	S04H2114	67
S03A8127	87	S03AD4132	83	S03AD8160	88	S04H2118S	62
S03A8129	87	S03AD4303S	90	S03AD8165	88	S04H2125SP	37
S03A8130	87	S03AD4307S	90	S03H2327S	61	S04H2132KV	43
S03A8132	87	S03AD4317	90	S03S8117	88	S04H2141S	62
S03A8133	87	S03AD4319	90	S03S8119	88	S04H2184SV	41
S03A8134	87	S03AD4321	90	S03S8121	88	S04H3106	67
S03A8135	87	S03AD4414S	84	S03SD8117	88	S04H3107	67
S03A8136	87	S03AD4503S	90	S03SD8119	88	S04H3108	67
S03A8138	87	S03AD4517	90	S03SD8121	88	S04H3109	67
S03A8140	87	S03AD4519	90	S03V2106	117	S04H3110	67
S03A8141	87	S03AD4521	90	S03V2108	117	S04H3111	67
S03A8144	87	S03AD6107S	86	S03V2110	117	S04H3112	67
S03A8146	87	S03AD6120S	86	S03V2114	117	S04H3113	67
S03A8150	87	S03AD6126	86	S03V3108	117	S04H3114	67
S03A8155	87	S03AD6127	86	S03V3110	117	S04H3115	67

S04H3116	67	S04H4726SP	38	S04H6424	70	S04HD4118	69
S04H3117	67	S04H4728S	38	S04H6426	70	S04HD4119	69
S04H3118	67	S04H4728SP	38	S04H6427	70	S04HD411S	69
S04H3119	67	S04H5129SC	45	S04H6429	70	S04HD4120	69
S04H3120	67	S04H524127S	66	S04H6430	70	S04HD4121	69
S04H3121	67	S04H52460S	65	S04H6432	70	S04HD4122	69
S04H3122	67	S04H52477S	65	S04H6433	70	S04HD4123	69
S04H3124	67	S04H52478S	65	S04H6435	70	S04HD4124	69
S04H3125S	62	S04H6115S	63	S04H6436	70	S04HD4125	69
S04H3141S	62	S04H6119	69	S04H6438	70	S04HD4126	69
S04H3157S	62	S04H6121	69	S04H6440	70	S04HD4127	69
S04H3157SP	37	S04H6122	69	S04H6441	70	S04HD4128	69
S04H3194SV	41	S04H6124	69	S04H6443	70	S04HD4130	69
S04H3536S	62	S04H6127	69	S04H6444	70	S04HD4132	69
S04H3536SP	37	S04H6128	69	S04H6446	70	S05	Pag.
S04H4108	68	S04H6130	69	S04H6447	70	S05A408S	89
S04H4109	68	S04H6132	69	S04H6450	70	S05A4H10	88
S04H4110	68	S04H6134	69	S04H6456	70	S05A4H12	88
S04H4111	68	S04H6136	69	S04H8115S	63	S05A4H14	88
S04H4112	68	S04H6138	69	S04H8355	71	S05A4H17	88
S04H4113	68	S04H6141	69	S04H8360	71	S05A4H18	88
S04H4114	68	S04H6146	69	S04H8365	71	S05A4H19	88
S04H4115	68	S04H6150	69	S04HD2106	67	S05A4H4	88
S04H4116	68	S04H6152	69	S04HD2107	67	S05A4H5	88
S04H4117	68	S04H624101S	66	S04HD2108	67	S05A4H6	88
S04H4118	68	S04H6319	70	S04HD2110	67	S05A4H8	88
S04H4119	68	S04H6321	70	S04HD2111	67	S05A6105S	86
S04H4120	68	S04H6321S	63	S04HD2112	67	S05H4113S	71
S04H4121	68	S04H6322	70	S04HD2113	67	S05H4213S	71
S04H4122	68	S04H6323	70	S04HD3109	68	S05HD4110	71
S04H4123	68	S04H6324	70	S04HD3110	68	S05HD4111	71
S04H4124	68	S04H6325	70	S04HD3111	68	S05HD4112	71
S04H4125	68	S04H6326	70	S04HD3112	68	S05HD4113	71
S04H4125S	63	S04H6327	70	S04HD3113	68	S05HD4113S	71
S04H4125SP	37	S04H6329	70	S04HD3114	68	S05HD4117	71
S04H4126	68	S04H6330	70	S04HD3115	68	S05HD4118	71
S04H4127	68	S04H6332	70	S04HD3116	68	S05HD4119	71
S04H4128	68	S04H6334	70	S04HD3117	68	S05HD4120	71
S04H4129	68	S04H6336	70	S04HD3119	68	S05HD4121	71
S04H4130	68	S04H6338	70	S04HD3120	68	S05HD4122	71
S04H4131SP	38	S04H6341	70	S04HD3121	68	S05HD4123	71
S04H4132	68	S04H6346	70	S04HD4109	69	S05HD4124	71
S04H4134	68	S04H6350	70	S04HD4110	69	S05HD4127	71
S04H4136	68	S04H6355	70	S04HD4111	69	S05HD4130	71
S04H4144KV	43	S04H6356	70	S04HD4112	69	S05HD4132	71
S04H42165SV	41	S04H6360	70	S04HD4113	69	S05HD4213S	71
S04H4295SV	41	S04H6365	70	S04HD4114	69	S06	Pag.
S04H4524S	38	S04H6419	70	S04HD4115	69	S06A408S	89
S04H4524SP	38	S04H6421	70	S04HD4116	69	S06A4T20	89
S04H46121SV	41	S04H6422	70	S04HD4117	69	S06A4T27	89

S06A4T30	89	S07H230	74	S09H305	75	S10H3100	77
S06A4T40	89	S07H240	74	S09H306	75	S10H3120	77
S06A4T45	89	S07H310	74	S09H307	75	S10H340	77
S06A4T50	89	S07H315	74	S09H308	75	S10H350	77
S06A4T55	89	S07H320	74	S09H310	75	S10H355	77
S06A4T60	89	S07H325	74	S09H312	75	S10H360	77
S06A4T70	89	S07H327	74	S09H314	75	S10H370	77
S06A4T80	89	S07H330	74	S09H404	76	S10H380	77
S06H204	73	S07H340	74	S09H405	76	S10H4100	77
S06H205	73	S07H345	74	S09H406	76	S10H4110	77
S06H206	73	S07H350	74	S09H407	76	S10H4120	77
S06H207	73	S07H355	74	S09H408	76	S10H480	77
S06H208	73	S07H360	74	S09H410	76	S10H490	77
S06H210	73	S07H4109S	64	S09H4109S	64	S11	Pag.
S06H211	73	S07H420	74	S09H4118SP	38	S11H200	77
S06H306	73	S07H425	74	S09H412	76	S11H201	77
S06H307	73	S07H427	74	S09H414	76	S11H202	77
S06H308	73	S07H430	74	S09H416	76	S11H203	77
S06H310	73	S07H4320	75	S09H417	76	S11H300	77
S06H311	73	S07H4325	75	S09H419	76	S11H301	77
S06H312	73	S07H4327	75	S09H4304	76	S11H302	77
S06H314	73	S07H4330	75	S09H4305	76	S11H303	77
S06H316	73	S07H4340	75	S09H4306	76	S11H304	77
S06H318	73	S07H4345	75	S09H4307	76	S11H402	77
S06H320	73	S07H4350	75	S09H4308	76	S11H403	77
S06H37S	71	S07H4352	75	S09H4309	76	S11H404	77
S06H410	73	S07H4355	75	S09H4310	76	S12	Pag.
S06H411	73	S07H4360	75	S09H4312	76	S12A4525S	89
S06H412	73	S07H4370	75	S09H4314	76	S14	Pag.
S06H4127S	63	S07H440	74	S09H4316	76	S14A4108S	103
S06H414	73	S07H445	74	S09H4317	76	S14A4117	103
S06H416	73	S07H450	74	S09H4319	76	S14A4118	103
S06H418	73	S07H4530	75	S09V3H4	118	S14A4120	103
S06H420	73	S07H4540	75	S09V3H5	118	S14A4121	103
S06H422	73	S07H4545	75	S09V3H6	118	S14A4123	103
S06H424	73	S07H455	74	S09V3H8	118	S14A4124	103
S06H425S	63	S07H460	74	S09V41H10	118	S14A4126	103
S06H427KV	44	S07H470	74	S09V41H4	118	S14A4127	103
S06H427SP	38	S07H4932S	64	S09V41H5	118	S15	Pag.
S06H49S	71	S08	Pag.	S09V41H6	118	S15H240	79
S07	Pag.	S08H208S	103	S09V41H8	118	S15H356	79
S07H206	74	S08H311S	75	S10	Pag.	S15H472	79
S07H207	74	S09	Pag.	S10H230	76	S15H6109	79
S07H208	74	S09H203	75	S10H235	76	S16	Pag.
S07H209	74	S09H204	75	S10H240	76	S16H1234	38
S07H210	74	S09H205	75	S10H245	76	S16H1238	38
S07H215	74	S09H206	75	S10H250	76	S16H1438	38
S07H220	74	S09H207	75	S10H255	76	S16H302	38
S07H225	74	S09H303	75	S10H260	76	S16H304	38
S07H227	74	S09H304	75	S10H270	76	S16H3410	38

S16H3412	38	S24H250	81	S43V48	119	S63H4307	78
S16H3812	38	S24H3150	81	S44	Pag.	S63H4308	78
S16H3814	38	S24H3200	81	S44H2206	82	S63H4310	78
S16H403	80	S24H3250	81	S44H3110A	82	S63H4312	78
S17	Pag.	S24H375	81	S44H4110	82	S63H4313	78
S17H3116	80	S24H4125	81	S46	Pag.	S63H4405	78
S17H3121	80	S24H4224	81	S46TE80	90	S63H4406	78
S17H3414	80	S24H4250	81	S49	Pag.	S63H4407	78
S17H4116	80	S24H450	81	S49H4105	78	S63H4408	78
S17H4121	80	S24H475	81	S49H4106	78	S63H4409	78
S18	Pag.	S24H6100	81	S49H4108	78	S63H4410	78
S18A4103MS	89	S24H6200	81	S49H4110	78	S63H4412	78
S18A4115	90	S24H6400	81	S49H4112	78	S63H4413	78
S18A4117	90	S24H8200	81	S49H4114	78	S63H4414	78
S18A4117M	89	S25	Pag.	S49H4116	78	S63H4507S	78
S18A4119	90	S25V310	118	S49H4308	78	S63H4605	78
S18A4119M	89	S25V36	118	S49H4310	78	S63H4606	78
S18A4121	90	S25V410	118	S49H4312	78	S63H4607	78
S18A4121M	89	S25V45	118	S49H4314	78	S63H4608	78
S18AD4117	90	S26	Pag.	S49H4318	78	S63H4609	78
S18AD4119	90	S26H2150	81	S50	Pag.	S63H4610	78
S18AD4121	90	S26H2280	81	S50H3106S	78	S63H4612	78
S21	Pag.	S27	Pag.	S50H3206S	78	S63H4613	78
S21H41125	80	S27H2	81	S54	Pag.	S63H4614	78
S21H41250	80	S27H3	81	S54H5509S	78	S63H4708	79
S21H4150	80	S27H4	81	S57	Pag.	S63H4709	79
S21H4175	80	S29	Pag.	S57H108	58	S63H4710	79
S22	Pag.	S29H2133S	103	S57H108S	58	S63H4712	79
S22H21130	80	S29H2180S	105	S57H110	58	S63H4713	79
S22H21130RK	80	S29H4140SP	38	S57H111	58	S63H4714	79
S22H31200	80	S29H4141KV	44	S57H113	58	S63H4808	79
S22H41375	80	S40	Pag.	S57H115	58	S63H4809	79
S22H41375RK	80	S40T108	81	S57H116	58	S63H4810	79
S22H41450	80	S40T109S	81	S57H117	58	S63H4812	79
S22H41450RK	80	S40T110	81	S57H118	58	S63H4813	79
S22H41600	80	S40T112	81	S57H119	58	S63H4814	79
S22H41600RK	80	S40T113	81	S57H121	58	S64	Pag.
S22H6500	80	S40T114	81	S57H123	58	S64A4106S	89
S22H6500RK	80	S40T117	81	S57H125	58	S64A6306S	89
S23	Pag.	S40T119	81	S57H127	58	S64H4104	79
S23H21115	81	S41	Pag.	S57H132	58	S64H4105	79
S23H31200	81	S41H41	81	S60	Pag.	S64H4106	79
S23H41250	81	S42	Pag.	S60H4304S	82	S64H4107	79
S23H41300	81	S42M403S	81	S63	Pag.	S64H4109	79
S23H6450	81	S42M4125	81	S63H3306	78	S64H4113	79
S23H6500	81	S42M4250	81	S63H3307	78	S64H4126S	64
S23H8550	81	S42M475	81	S63H3308	78	S64H4204	79
S24	Pag.	S43	Pag.	S63H3310	78	S64H4205	79
S24H2100	81	S43H210	81	S63H4132S	64	S64H4206	79
S24H2150	81	S43V38	119	S63H4306	78	S64H4207	79

S64H4208	79	S66HD4119	72	T10317	49	T27-D4R2	50
S64H4209	79	S66HD4120	72	T10318	49	T27-D6R	50
S64H4210	79	S66HD4121	72	T10319	49	T27-D8R	50
S64H4212	79	S66HD4122	72	T10321	49	T27010N	49
S64H4214	79	S66HD4123	72	T10322	49	T27020N	49
S64H4216	79	S66HD4124	72	T10324	49	T27021N	49
S64H4218	79	S66HD4127	72	T10H1210S	49	T27060N	49
S64H4705	79	S66HD4130	72	T14	Pag.	T271001N	49
S64H4706	79	S66HD4132	72	T14100N	49	T27101N	49
S64H4708	79	S68	Pag.	T14200N	50	T27200N	49
S64H4709	79	S68H2103	60	T15	Pag.	T27340N	49
S64H4710	79	S68H2104	60	T154100N	50	T27800N	49
S64H4712	79	S68H21045	60	T154100N-R	50	T29	Pag.
S64H4714	79	S68H2105	60	T154200N-R	50	T29014	49
S64H4808	79	S68H21055	60	T16	Pag.	T30	Pag.
S64H4810	79	S68H2106	60	T16005N-R	50	T30200NS	49
S64H4812	79	S68H21065	60	T19	Pag.	T33	Pag.
S64H4814	79	S68H2107	60	T19135N	50	T33050N	49
S66	Pag.	S68H2108	60	T19200N	50	T33050N-R	50
S66H4108	72	S68H2109	60	T21	Pag.	T33101N	49
S66H4110	72	S68H2110	60	T21025N	49	T33101N-R	50
S66H4111	72	S68H2111	60	T21025N-R	50	T33200N	49
S66H4112	72	S68H2112	60	T21050N	49	T33200N-R	50
S66H4113	72	S68H2113	60	T21050N-R	50	T33341N	49
S66H4114	72	S68H2114	60	T211000N	49	T33341N-R	50
S66H4115	72	S68H2141S	60	T211000N-R	50	V10	Pag.
S66H4116	72	S68H4127S	60	T21101N	49	V1001	95
S66H4117	72	S68H5234111S	61	T21101N-R	50	V1002	95
S66H4118	72	T04	Pag.	T21200N	49	V1002-RK	95
S66H4119	72	T04M060-R	50	T21200N-R	50	V1003	95
S66H4120	72	T04M061-R	50	T21340N	49	V1005	95
S66H4121	72	T04M150-R	50	T21340N-R	50	V11	Pag.
S66H4122	72	T04M250-R	50	T21341N	49	V11011SC	45
S66H4124	72	T07	Pag.	T21341N-R	50	V1103	94
S66H4125	72	T07030N-R	50	T21550N	49	V13	Pag.
S66H4126	72	T07110N-R	50	T21550N-R	50	V1310A-11	95
S66H4127	72	T07350N-R	50	T24	Pag.	V1310B-11	95
S66H4128	72	T07700N-R	50	T24200	50	V1310C	95
S66H4130	72	T09	Pag.	T24200-R	50	V1310E	95
S66H4132	72	T094602	52	T25	Pag.	V1310E-11	95
S66H4136	72	T094602-RK	52	T25100N	50	V1310F	95
S66HD4110	72	T096801	52	T25100N-R	50	V1310F-11	95
S66HD4111	72	T096801-RK	52	T25200N	50	V1310G-11	95
S66HD4112	72	T10	Pag.	T25200N-R	50	V1310J-11	95
S66HD4113	72	T10148	52	T25340N	50	V1310SP	39
S66HD4114	72	T102001S-R	50	T25340N-R	50	V1311A	95v
S66HD4115	72	T10313	49	T27	Pag.	V14	Pag.
S66HD4116	72	T10314	49	T27-D2R	50	V1401	95
S66HD4117	72	T10315	49	T27-D3R	50	V1403	95
S66HD4118	72	T10316	49	T27-D4R1	50		

V15	Pag.	W243032	56	W26107	57	W27	Pag.
V1501	95	W24A107S	52	W26108	57	W27AK8	60
V1505	95	W24A109SP	39	W26108KV	44	W27AR10	59
V21	Pag.	W24N0810	56	W26109	57	W27AR8	59
V2101	95	W24N1113	56	W26110	57	W27AS10	59
V2102	95	W24N1214	56	W26110KV	44	W27AS15	59
V24	Pag.	W24N1719	56	W26111	57	W27AS18	59
V2401	95	W25	Pag.	W26112	57	W27AS8	59
W23	Pag.	W250607	56	W26112S	57	W27AT02SC	45
W230607	56	W250809	56	W26112SP	39	W27AT10	59
W230809	56	W251011	56	W26113	57	W27AT12	59
W231011	56	W251012	56	W26114	57	W27AT15	59
W23108S	56	W25106KV	44	W26114S	57	W27AT8	59
W23108SP	39	W25107KV	44	W26115	57	W28	Pag.
W231213	56	W25108S	56	W26116	57	W2808	60
W231415	56	W25110KV	44	W26116KV	44	W2810	60
W231617	56	W25110SP	39	W26116SP	39	W2810RJ-HL	60
W231819	56	W25117SC	45	W26117	57	W2812	60
W232022	56	W251213	56	W26118	57	W2812RJ-HL	60
W232123	56	W251415	56	W26119	57	W2814	60
W232426	56	W251417	56	W26120	57	W2814RJ-HL	60
W232427	56	W251617	56	W26121	57	W2818	60
W232528	56	W251719	56	W26122	57	W2818RJ-HL	60
W233032	56	W251819	56	W26123	57	W2824	60
W23559SV	42	W252022	56	W26124	57	W2824RJ-HL	60
W23V108	119	W252123	56	W26125	57	W2836	60
W23V110	119	W252426	56	W26126	57	W2836RJ-HL	60
W23V111	119	W252427	56	W26126S	57	W28HD10	60
W23V112	119	W252528	56	W26127	57	W28HD8	60
W23V113	119	W252730	56	W26128	57	W29	Pag.
W23V114	119	W252732	56	W26129	57	W290608	57
W23V116	119	W253032	56	W26130	57	W290711	57
W23V117	119	W253236	56	W26132	57	W291012	57
W23V118	119	W253641	56	W26134	57	W291418	57
W23V119	119	W254146	56	W26134SV	42	W291622	57
W23V121	119	W254650	56	W26136	57	W292024	57
W23V122	119	W25V108	119	W26138	57	W39	Pag.
W23V124	119	W25V109	119	W26141	57	W391011	57
W24	Pag.	W25V110	119	W26142	57	W39108SA	57
W240809	56	W25V1125SV	119	W26144	57	W391213	57
W241011	56	W25V113	119	W26146	57	W391415	57
W241012	56	W25V114	119	W26148	57	W391617	57
W24106S	56	W25V117	119	W26150	57	W391819	57
W241314	56	W25V118	119	W26155	57	W43	Pag.
W241417	56	W25V119	119	W26160	57	W43A0607	58
W241617	56	W25V121	119	W26165	57	W43A0809	58
W241719	56	W25V122	119	W2623431SV	42	W43A1011	58
W241819	56	W25V124	119	W26315SV	42	W43A106S	58
W241922	56	W26	Pag.	W26411PRS	57	W43A1213	58
W242528	56	W26106	57	W26414S	57	W43A1415	58

W43A1617	58	W6211011	55	W67146	59	W77A155	59
W43A1819	58	W6211213	55	W67150	59	W77A160	59
W45	Pag.	W6211415	55	W67155	59	W77A165	59
W45108	53	W6211617	55	W67160	59	W77H01	59
W45109	53	W6211819	55	W67165	59	W77H02	59
W45110	53	W6212022	55	W67170	59	W77H03	59
W45111	53	W6212427	55	W68	Pag.	W77H04	59
W45112	53	W6212528	55	W680809	54	W84	Pag.
W45112SP	39	W6213032	55	W680810	54	W84106	61
W45113	53	W65	Pag.	W681011	54	W84107	61
W45114	53	W65105KV	44	W68106S	54	W84108	61
W45115	53	W6510810	58	W681213	54	W84108S	61
W45116	53	W6511012	58	W681415	54	W84109	61
W45117	53	W6511315	58	W681618	54	W84110	61
W45117S	53	W6511417	58	W681719	54	W84111	61
W45118	53	W6511922	58	W69	Pag.	W84112	61
W45119	53	W65A1012	58	W69116S	538	W84113	61
W45121	53	W65A105S	58	W70	Pag.	W84114	61
W45122	53	W65A1214	58	W70A118S	39	W84114S	61
W45124	53	W65A1315	58	W72	Pag.	W84115	61
W45127	53	W65A1618	58	W72117	59	W84116	61
W45130	53	W65A1719	58	W72118	59	W84117	61
W45132	53	W65A1922	58	W72119	59	W84118	61
W45316S	53	W65A2224	58	W72121	59	W84119	61
W45316S-AD	53	W66	Pag.	W72122	59	W86	Pag.
W45316S-AD12	53	W66107S	54	W72124	59	W86112S	61
W45316S-AD14	53	W66108	54	W72127	59	W91	Pag.
W45316S-AD34	53	W66109	54	W72130	59	W91107S	55
W45316S-AD38	53	W66110	54	W72132	59	W91110	55
W45316S-ADBH14	53	W66111	54	W72134	59	W91112	55
W47	Pag.	W66112	54	W72136	59	W91113	55
W47108SP	39	W66113	54	W72141	59	W91114	55
W51	Pag.	W66114	54	W72146	59	W91115	55
W51110S	53	W66115	54	W72150	59	W91117	55
W52	Pag.	W66116	54	W72155	59	W91119	55
W52105S	54	W66116S	54	W72170	59	W93	Pag.
W60	Pag.	W66117	54	W73	Pag.	W93108S	55
W60115SP	39	W66118	54	W73102S	54	W93110	55
W61	Pag.	W66119	54	W7310813	54	W93111	55
W611011	55	W66124	54	W7311419	54	W93112	55
W61106S	55	W67	Pag.	W77	Pag.	W93113	55
W611214	55	W67104S	54	W77A124	59	W93114	55
W611315	55	W67119	59	W77A127	59	W93115	55
W611618	55	W67121	59	W77A130	59	W93117	55
W611719	55	W67124	59	W77A132	59	W93119	55
W612224	55	W67130	59	W77A136	59	WF	Pag.
W62	Pag.	W67132	59	W77A138	59	WFS46	59
W6210607	55	W67136	59	W77A141	59	WV	Pag.
W6210809	55	W67138	59	W77A146	59	WV27AS10	119
W62108S	55	W67141	59	W77A150	59		

ARTIGO	PÁG.	ARTIGO	PÁG.
Acessórios de ar comprimido	180 a 182	Chave de rodas	127, 128
Acessórios para carros ferramenta	30, 31	Chave de tubos	60
Alavancas de chapeiro	156	Chave de tubos combustível	135
Alicate anéis de segurança	135	Chave de velas	80, 138
Alicate ajustável	91, 93, 116	Chave inglesa	59, 60
Alicate corta cabos	94, 116	Chave luneta	55 a 58
Alicate de cravar terminais	95	Chave mista	57, 58
Alicate de descarnar	95	Chave para bujão óleo	135, 137
Alicate de freios	91, 92, 135	Chave pata de galo	82
Alicate de pressão	96, 97	Chaves alternador	131
Alicate de rebitar	95	Chave cavilhas e encaixes plásticos	154 a 156
Alicate para abraçadeiras	144	Chaves de caixa	67 a 72, 117, 118
Alicates (universal, pontas, corte)	91 a 93, 116	Chaves de fenda	98, 99, 101, 102, 115
Alicates para tubos	140, 141, 144	Chaves de filtros	136 a 138
Alicate tensor abraçadeiras	141	Chaves de impacto	82 a 90
Alicates travões	140, 141	Chaves de velas incandescência	133
Aparafusadora pneumática	168	Chaves dinâmométricas	49, 50
Armários Oficiais	24 a 26	Chaves em L hexagonais	106 a 109
Aspirador / Aparadeira óleo	9, 126, 127	Chaves em L Torx	106 a 109
Assentador pneumático de válvulas	176	Chaves Phillips	98, 99, 115
Balanceiros	179	Chaves em T com ponta flexível	81
Bancada de trabalho	10	Chaves Pozi	100 a 102
Banco de apoio	7	Chaves remoção de painéis	154, 155
Bandeja magnética	127	Chaves retirar fêmeas danificadas	103, 143
Berbequim pneumático	167, 168	Chaves sensor oxigénio	138
Bits de caixa	74 a 79	Chaves SuperTech	60, 61
Bits e porta bits	103 a 105	Chaves Torx	100 a 102
Bomba de massa	179	Compasso	113
Bomba hidropneumática	6	Compressor molas	125
Cabo articulado (rabo de força)	80	Corta tubos	143
Cabo T correção	81	Cunhas chapeiro	156
Cabos arranque de bateria	144	Densímetro	143
Caixas de ferramenta	29, 30	Desandadores	157, 158
Caneta magnética	127	Despolidor de cilindros	142, 143
Cardan	79	Encontrador de chapeiro	156, 157
Carros e caixas vazios	27 a 29	Enroladores de ar	180
Carros e composições de ferramenta	13 a 23	Estrado de mecânico	7
Centrador embraiagens	140	Extensões	80 a 82, 118
Chave bocas	56, 1129	Extratores	124, 125
Chave de barra direção	125, 141	Faca pneumática	177
Chave de bocas perfil fino	57	Ferramenta isolada 1000Volts	115 a 119
Chave de cachimbo	58	Ferramenta para travões	140, 141
Chave de injetores	130, 133	Ferramenta rodar válvulas	134
Chave de pancada (bocas e luneta)	59	Ferramentas chapeiro	154 a 158

ARTIGO	PÁG.	ARTIGO	PÁG.
Ferramentas especiais mecânica	122 a 160	Ponteira para válvula pneum	127
Ferramentas especiais motas	152 a 154	Preguiças	8, 122
Ferramentas especiais pesados	159, 160	Prensas de chapeiro	8
Ferramentas especiais por marca	145 a 151	Punções	111, 112
Ferro de desmonta	142	Punho para chave caixa	81
Filtros de ar	180, 181	Raspadores/ riscadores	134
Fita métrica	113	Rebarbadora pneumática	170
Gambiarra sem fios	114	Rebitadora pneumática	178, 179
Grampo segmentos	131	Rectificadora pneumática	169, 170
Grampo válvulas	131	Reduções	80
Grua hidráulica	7	Refratómetro	126
Jogo de bits	103	Régua/ esquadro	113
Jogo chaves caixa com roquete	62 a 66	Riscadores	134
Kit comando motores	129, 130, 145 a 151	Reparador de roscas	139, 141
Kit remoção de rádios	145	Roquete pneumático	166, 167
Limas	112	Roquetes	50 a 52
Lixadora pneumática	170 a 173	Saca casquilhos	127
Macaco de chapeiro	8	Saca injectores	133, 134
Macaco de fossa/ transmissões	6	Sacas	123 a 125
Macaco de rodas/ hidropneumático	7	Seringa	126
Machos e caçonetos	34, 35, 128	Serra	112
Mala de electricista	143	Serra pneumática	175, 176
Mala de ferramenta	64, 66	Suporte de motores	8
Máquina decapar pneumática	176	Tabuleiros ferramenta (caixa plástico)	34 a 39, 45
Máquina descravar pneumática	168	Tabuleiros ferramenta (EVA)	40 a 44
Máquina pneumática impacto	162 a 166	Tabuleiros vazios	46 a 48
Martelo pneumático	178	Tesoura	94
Martelos	110	Tesoura pneumática	177
Martelos de chapeiro	156, 157	Teste atuadores	144
Medidor angular de torque	128	Teste compressão/ pressão	132, 133
Medidor de passo de rosca	128	Teste de vácuo/ pressão	134
Medidor de profundidade	142	Teste fluido travões	144
Medidor de pressão pneum	127	Teste fluxo e retorno injectores	132
Merchandising	184 a 187	Teste pressão radiadores	122
Micrómetro	114	Teste turbo	133
Molas de plástico	160	Tira mossas	157
Multímetros	9	Tomadas de ar	181, 182
Organizador de peças	131	Torno de bancada	31
Paquímetro	113	Travessa para portas	8
Pinça amperimétrica	9	Travessa para motores	7, 8
Pinças de chapeiro	157, 158	Tubo espiral para ar	181
Pistola de pintura	173, 174	Turquês	94
Pistola vaporizadora (tornado)	126	Ventosas	155
Pistoletes ar/ água	180	X-ato/ navalha	112, 113, 116
Polidora pneumática	170, 171		



Com ferramentas pneumáticas não utilizar chaves de caixa, juntas universais ou outras ferramentas de uso manual.



Não utilizar martelos ou tubos para aumentar o binário em chaves de aperto, chaves dinamométricas e roquetes.



Não utilizar chaves de parafusos como alavanca, punção ou escopro. Existem séries especiais de chaves de parafusos que podem ser marteladas.

Ferramentas Manuais

- Deverá ter bastante cuidado ao utilizar qualquer ferramenta, mantendo-a afastada das crianças.
- Recomenda-se utilizar sempre máscaras, óculos, auriculares e luvas de proteção (se aplicável).
- Deverá desligar sempre a energia elétrica antes de efetuar trabalhos em qualquer tipo de máquina ou equipamento elétrico ou junto de superfícies condutoras, pois poderão ocorrer choques elétricos. Nestes casos, utilizar sempre ferramentas isoladas.
- Deverá escolher o tipo e tamanho correto da ferramenta para o trabalho a realizar. As unidades de medida servem para selecionar a ferramenta com tamanho certo.
- Deverá manter as ferramentas limpas.
- Deverá ler as instruções antes de utilizar as ferramentas.
- Não deverá modificar nenhuma ferramenta.
- Nos carro de ferramentas, nunca deverá abrir mais do que uma gaveta de cada vez (perigo de tombar).
- Nos carro de ferramentas, nunca deverá usar uma gaveta como escada (perigo de tombar).
- Não deverá puxar de costas o carro de ferramentas.

Ferramentas Pneumáticas

As ferramentas pneumáticas Jonnesway permitem que os operadores usufruam de uma utilização segura, um desempenho excelente e reduzidas vibrações. As seguintes instruções de segurança são para as condições normais de utilização. Antes de utilizar as ferramentas pneumáticas, deverá ler com atenção estes avisos para evitar perigos desnecessários.

• Utilizar Proteção Pessoal

Deverá usar sempre proteção (como por exemplo máscaras, óculos, auriculares, luvas, etc.) quando manusear ferramentas pneumáticas de modo a evitar ferimentos.

• Evitar Danos Causados por Vibrações ou Movimentos de Trabalho Repetitivos

A exposição prolongada a vibrações ou a movimentos de trabalho repetitivos poderá ser prejudicial. Se sentir formigueiro, entorpecimento, desconforto ou dor, deverá parar de utilizar a ferramenta de imediato. Os operadores deverão seguir sempre as instruções a seguir indicadas:

- Utilizar as pegas do equipamento para garantir a sua rigidez e eficiência.
- Manter os pulsos o mais direito possível.
- Evitar movimentos muito repetitivos das mãos e pulsos.
- Manter as mãos e o corpo quentes e secos.
- Evitar a exposição contínua a vibrações por períodos muito prolongados.

**• Evitar os Perigos do Ar Comprimido**

- O ar sob pressão pode causar ferimentos. Por favor, observar as seguintes instruções de segurança para garantir um ambiente de trabalho seguro.
- Não direcionar o tubo do ar para si ou para outros. Deverá afastar o escape do ar de si próprio ou de outros.
- Antes de utilizar a ferramenta pneumática, verificar a existência de tubos e acessórios danificados ou soltos.
- Deverá desligar a ferramenta sempre que estiver a substituir acessórios, definir o aperto, efetuar reparações ou não estiver a ser utilizada.
- Deverá manter sempre a pressão do ar nos valores aconselhados, já que a utilização das ferramentas fora destes valores diminuirá o seu rendimento e a vida útil da ferramenta.
- Não ligar ferramentas pneumáticas a tomadas elétricas.
- Quando utilizar uniões universais de torção, deverão ser sempre instalados pinos/garfos de bloqueio para evitar que os tubos se desliguem acidentalmente.

• Evitar Perigos Adicionais

- Escorregadelas, tropeções e quedas são a causa principal de ferimentos e morte em acidentes de trabalho.
- Deverá ter cuidado com o excesso de tubos e cabos existentes na área de passagem ou na superfície de trabalho.
- Os operadores e técnicos de manutenção deverão estar fisicamente aptos para efetuar as suas tarefas e suportar o volume, peso e potência da ferramenta.
- Deverão ser utilizadas proteções nas rebarbadoras para reduzir o risco de cortes e escoriações devido às rebarbas.

Sistema Pneumático de Alimentação

- ① Filtro
- ② Drenagem
- ③ Secador de Ar
- ④ Depósito de Ar
- ⑤ Compressor de Ar
- ⑥ Filtro Regulador - Lubrificador

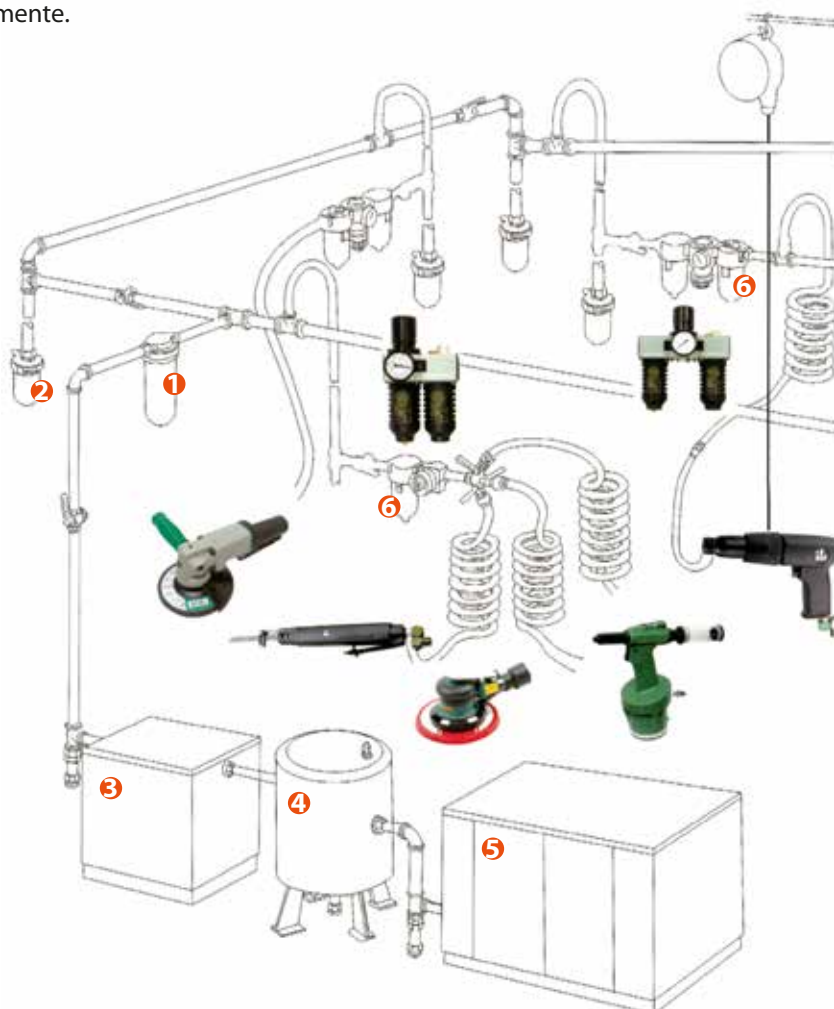

Recomendações de Manutenção

Quando ligar a ferramenta pneumática à rede de ar comprimido, deverá certificar-se que a pressão de alimentação desta deverá ser de 6.2kg/cm² (90PSI), já que se esta for demasiado elevada poderá danificar a ferramenta e se for demasiado baixa influenciará o funcionamento da mesma, reduzindo a sua vida útil.

- É recomendável a instalação dos filtros reguladores-lubrificadores adequados à ferramenta pneumática em uso. A entrada do ar deverá ter óleo lubrificante apropriado, de modo a lubrificar o motor interno da ferramenta. (Colocar um papel branco na saída do ar para verificar se existe uma sujidade gordurosa, que indique a existência de óleo suficiente).
- A entrada de ar não deverá ter água. Se tal ocorrer, recomenda-se a verificação ou instalação de um secador de ar.
- Não deverá desmontar a ferramenta, pois poderá danificá-la e afetar a segurança do utilizador.
- Mesmo que a ferramenta possua danos menores ou não efetue as funções indicadas pelo fabricante, não deverá utilizá-la até que seja inspecionada.
- Para manter o bom desempenho da ferramenta, deverá efetuar verificações regulares (semanalmente) e manutenções preventivas e lubrificações (adicionar massa lubrificante às peças rotativas e óleo lubrificante no motor).
- Sempre que utilizar as ferramentas pneumáticas deverá cumprir com as normas de segurança e instruções de funcionamento (quer aplicáveis à proteção do utilizador, quer à correta utilização da ferramenta).
- É essencial escolher as ferramentas certas e adequadas para o trabalho a realizar, já que se a ferramenta tiver uma potência muito elevada, poderá causar danos na peça em que está a trabalhar e se tiver pouca potência, poderá ficar danificada.

Condições Gerais de Garantia

A ferramenta manual e pneumática Jonnesway é fabricada com os mais elevados padrões de qualidade, mas é, para todos os efeitos, uma ferramenta de desgaste. É pois normal que a ferramenta sofra alteração de algumas características físicas durante o período de utilização, mesmo quando usada em condições normais.

Assim, a garantia da ferramenta fica dependente do conjunto das seguintes condições gerais:

- Para ferramentas manuais é oferecida uma garantia de “vida útil”, garantia esta que cobre defeitos de materiais e fabrico.
Entende-se como “vida útil” o período de tempo de vida expectável para a peça de ferramenta em causa, desde que utilizada sempre nas condições normais de utilização e para as quais foi concebida.
- A gama de ferramentas pneumáticas e ferramentas de medição estão excluídas do ponto anterior. Os produtos foram desenhados e fabricados para uso profissional. O período de garantia é de um ano (12 meses) para uso profissional e de dois anos (24 meses) para uso particular. O período de garantia inicia-se à data da aquisição. Esta data deve ser verificada mediante a fatura de aquisição.
- Qualquer produto que tenha sido utilizado ou mantido de forma incorreta, que tenha sofrido um desgaste devido a uma utilização inadequada ou que tenha sido sujeito a alterações não autorizadas, não está coberto pela garantia.
- A ausência de manutenção preventiva ou a utilização de ar comprimido com pressão e lubrificação desajustadas são motivo para a perda imediata da garantia.



JONNESWAY.

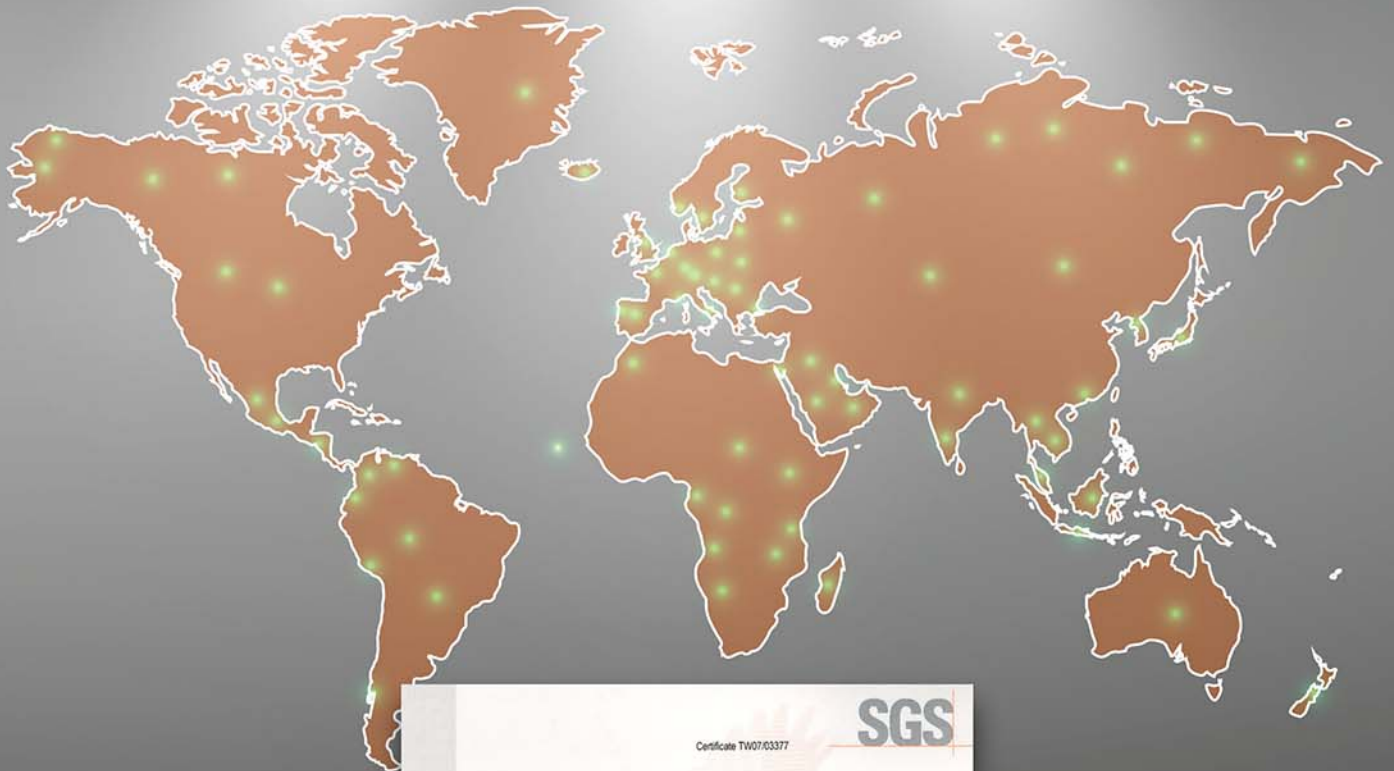

Certificate TW07/03377

The management system of

JONNESWAY ENTERPRISE CO., LTD.

6F 9, No. 51, Sec. 2, Keelung Rd., Taipei City

has been assessed and certified as meeting the requirements of

ISO 9001:2015

For the following activities

Design and trading management of JONNESWAY brand of professional hand tools, pneumatic tools, automobile repair tools, garage equipment and working machines.

This certificate is valid from 14 February 2019 until 14 February 2022 and remains valid subject to satisfactory surveillance audits. Recertification audit due a minimum of 60 days before the expiration date. Issue 6. Certified since 14 February 2007

Authorized by



SGS United Kingdom Ltd
Rosemere Business Park, Rosemere Park, Cheshire, CH65 3EN, UK
t+44 (0)151 350-8888 f+44 (0)151 350-8000 www.sgs.com

HC SGS 9001 2015 DE18
Page 1 of 1







This document is issued by the Company subject to its General Conditions of Certification Services available at www.sgs.com/terms_and_conditions. The Applicant is bound by the conditions of supply, requirements and performance objectives stated therein. The Applicant is the responsible party for all data supplied to SGS. SGS does not warrant the results or products certified. It does not warrant any unmentioned elements, regions or jurisdictions of the product or processes. If the Applicant is a company and therefore may be presented to the public, it is the responsibility of the Applicant.



JONNESWAY®

Ferramentas Profissionais Manuais e Pneumáticas



Importador para Portugal, França, Espanha, Angola e Cabo Verde



Lusilectra
Salvador Caetano

Rua Engº Ferreira Dias, 953/993 • 4100-247 Porto • Portugal
Tel. +351 226 198 750 • Fax. +351 226 158 669
Email. equip.oficina@lusilectra.pt • www.lusilectra.pt

Distribuidor / Revendedor

