



JONNESWAY®

Uma marca para a vida



*de profissionais
para profissionais*

2022



JONNESWAY®

Ferramentas Profissionais Manuais e Pneumáticas

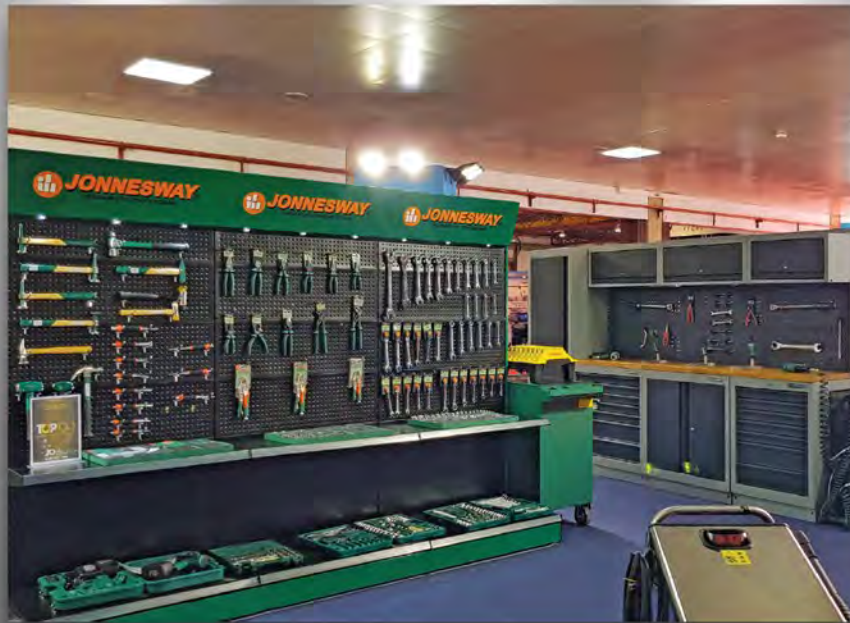

Este catálogo anula e substitui todas as edições anteriores.
Todos os preços apresentados nesta tabela estão sujeitos a IVA à taxa legal em vigor.

A Jonnesway está em constante desenvolvimento dos seus produtos, portanto, os modelos, composições, características técnicas, físicas, design e preços podem ser alterados, substituídos ou mesmo retirados deste catálogo sem aviso prévio e sem obrigação de efetuar qualquer alteração nas ferramentas e/ou equipamentos vendidos anteriormente. As capacidades indicadas para os produtos, são as que resultaram dos ensaios realizados nos laboratórios da Jonnesway, não sendo portanto contratuais.



www.jonneswaytools.com



facebook.com/jonneswaytools



Lusilectra
Salvador Caetano

Catálogo versão 3.5
Entra em vigor em janeiro de 2022

Carros e Composições de Ferramentas

Carros e composições de ferramentas 5-17

Armários e carros para ferramentas 18-22

Malas vazias e complementos para carros 23-25

Ferramenta Manual

Tabuleiros de ferramenta 28-43

Ferramenta de aperto 44-87

Alicates 88-95

Chaves 96-109

Martelos 110

Diversos 111-114

Ferramenta isolada a 1 000V 115-119

Ferramenta Especial Mecânica

Mecânica 122-153

Motociclos 154-156

Chapeiro 156-160

Pesados 161

Acessórios 162

Ferramenta Pneumática

Ferramenta pneumática 164-182

Acessórios para redes de ar comprimido 183-185

Merchandising

Merchandising 188-191

Outros Equipamentos

Outros equipamentos 194-197





JONNESWAY®

Ferramentas Profissionais
• Manuais • Pneumáticas •
específicas para automóvel, motociclos e pesados





JONNESWAY®

Carros e Composições de Ferramentas



Carros e
composições
de ferramentas

Malas vazias
e acessórios
para carros



Armários e
carros para
ferramentas

As suas necessidades ...



... a nossa solução!

Desenvolvemos soluções exclusivas para si!

EVA POWER

Carro com composição de ferramentas em **Tabuleiros EVA**

TABULEIROS

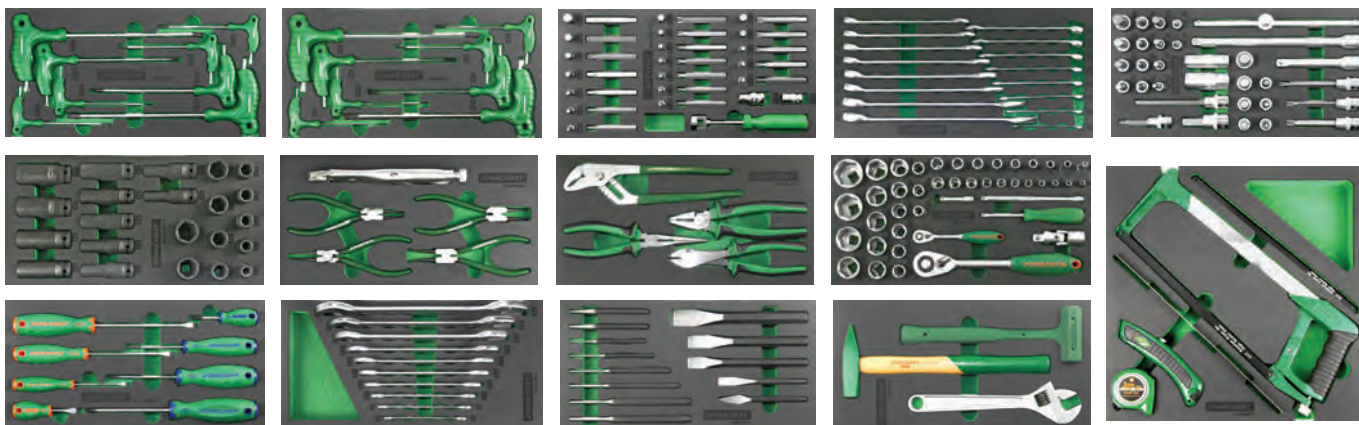

Composição:

- S04H4144KV Jogo de chaves de caixa com roquete de 1/2" e 1/4" com 44 peças
- S04H2132KV Jogo de chaves de vela, extensões e bits com 32 peças
- W26116KV Jogo de chaves mistas com 16 peças
- S03A4122KV Jogo de chaves de impacto de 1/2" com 22 peças
- M63113KV Jogo de punções, saca troços e talhadeiras com 13 peças
- D71PP08KV Jogo de chaves de fenda/ phillips com 8 peças
- W25110KV Jogo de chaves de bocas com 10 peças

- P011804KV Jogo de alicates com 4 peças
- S29H4141KV Jogo com chave de travões e bits com 41 peças
- H10MB08KV Jogo de chaves hexagonais de punho com 8 peças
- H10MT08KV Jogo de chaves torx de punho com 8 peças
- M09103KV Jogo de martelos com 3 peças
- P32M105KV Jogo de alicates de freios com 5 peças
- MHS08KV Jogo com serra, régua, x-ato e fita métrica

CARROS



C-6DWB1



C-7DC2B



EVA POWER-V	Cor: verde 	1 970.00€
EVA POWER-C	Cor: cinza 	1 970.00€

EVA POWER BLACK	Cor: preto 	1 735.00€
------------------------	--	-----------

MEC SOLUTION

Carro de ferramentas com composição flexível, ajustável às suas necessidades

Adicione **3 TABULEIROS EVA**, sendo **1 do TIPO A** e **2 do TIPO B** e finalmente escolha o carro que vá de encontro das suas necessidades

TABULEIROS TIPO

A



S04H42165SV



S04H3194SV

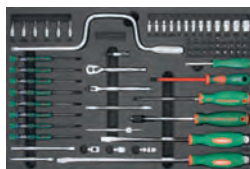

S04H2184SV



S04H4295SV



S04H46121SV

TABULEIROS TIPO

B



W2623431SV



D737128SV



H10121SV



D737134SV



P82736SV



P82714SV



W23559SV

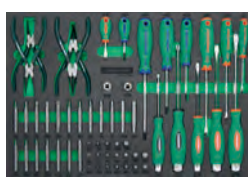

D71157SV



W26134SV

A



B



B



CARRO

CARROS

CARRO



C-6DWB1



C-7DC2B



MEC SOLUTION-V	Cor: verde		1 550.00€
MEC SOLUTION-C	Cor: cinza		1 550.00€

MEC SOLUTION BLACK	Cor: preto		1 450.00€
---------------------------	------------	--	-----------

POWER LINE

Carro com composição de ferramentas universal para mecânico auto ou técnico de manutenção industrial

TABULEIROS



Composição:

Jogo 4 alicates de freios
 Jogo 3 alicates (universal/ pontas/ corte)
 Jogo 2 martelos e cinzeis
 Jogo 8 chaves fenda/ philips
 Jogo 9 chaves macho hexagonal

Jogo 8 chaves torx dupla punho
 Jogo serra, punções e chave inglesa
 Jogo alicate pressão e alicate ajustável
 Jogo chaves caixa com roquete 1/4"
 Jogo chaves caixa com roquete 1/2"

Jogo bits caixa 1/2" e 3/8"
 Jogo bits 1/2" e 3/8"
 Jogo 10 chaves de bocas
 Jogo 16 chaves mistas
 Jogo 8 chaves luneta 75°

CARROS



C-6DWB1



C-7DC2B

MEC POWER 19V Cor: verde  1 690.00€
MEC POWER 19C Cor: cinza  1 690.00€

BLACK POWER 19 Cor: preto  1 470.00€



MEC PROF-20

Carro de ferramentas para mecânico

TABULEIROS



Composição: 271 peças

Tabuleiro com

Jogo chaves de caixa longa 1/4" e 1/2" de 6 a 27mm
 Jogo chaves de caixa 1/4", 1/2" e 3/4" de 6 a 36mm
 Jogo extensões de 1/4", 1/2" e 3/4"
 Adaptadores
 Cardans
 Jogo chaves de caixa torx de 1/4" e 1/2" de E5 a E 24

Tabuleiro com

Jogo chaves luneta de 10 a 22mm
 Jogo alicates de pontas pequenos
 Jogo de chaves de hexagonais curtas
 Apalpa folgas
 Martelo pena esférica
 Chave inglesa

Tabuleiro com

Jogo chaves mistas de 6 a 34mm

Tabuleiro com

Jogo chaves fenda, Philips e torx com punho
 Chave de caixa com punho

Tabuleiro com

Jogo alicates longos, universal, pontas, corte, pressão, ajustável
 Chave de filtros

Tabuleiro com

Jogo de roquetes 1/4", 3/4", 1/2", 3/8"
 Roquete extensível de 1/2"
 Jogo bits curtos e longos 1/2"
 Jogo chaves de caixa torx de 1/2"
 Jogo chaves ribe de 1/2"
 Jogo chaves estriadas de 1/2"
 Jogo de chaves de hexagonais 1/2"

CARROS



C-6DWB1



C-7DC2B



MEC PROF20-V

Cor: verde



2 150.00€

MEC PROF20-C

Cor: cinza



2 150.00€

MEC PROF20-BLACK

Cor: preto



1 985.00€

ELECTR. 1000volts

Carro de electricista com composição de ferramenta isolada a 1 000volts

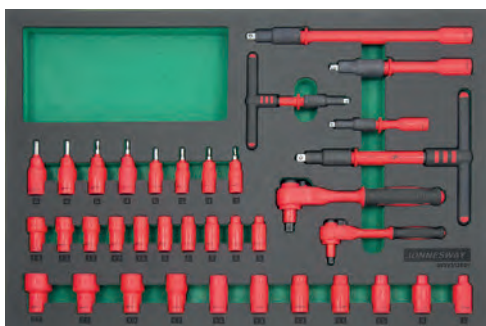
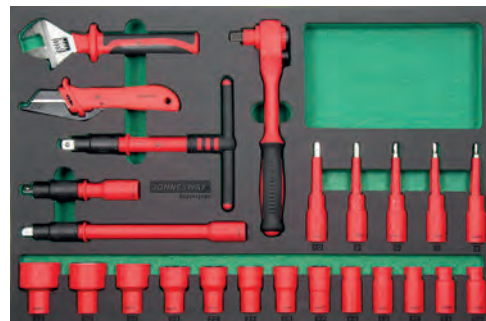
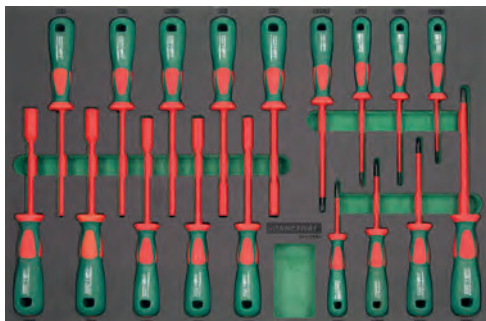
TABULEIROS

Composição:

Tabuleiro com 18 chaves isoladas

- 4 Chaves de fenda
- 4 Chaves phillips
- 10 Chaves de caixa de punho

Tabuleiro com 36 peças 1/4" e 3/8"

- 2 Roquete 1/4" e 3/8"
- 2 Cabo T de 1/4" e 3/8"
- 1 Extensão 100mm de 1/4"
- 10 Chaves de caixa 1/4"
- 4 Bits de caixa 1/4"
- 2 Extensões 3/8"
- 11 Chaves de caixa 3/8"
- 4 Bits de caixa 3/8"

Tabuleiro com 24 peças 1/2"

- 1 Roquete
- 1 Cabo T
- 2 Extensões
- 13 Chaves de caixa
- 5 Bits de caixa
- 1 Chave inglesa
- 1 X-ato

Tabuleiro com 25 peças

- 9 Chaves de bocas
- 13 Chaves de luneta
- 1 Alicate universal
- 1 Alicate de corte
- 1 Alicate de pontas

CARROS

C-6DWB1



C-7DC2B

ELECTR. 1000-V

Cor: verde



2 420.00€

ELECTR. 1000-C

Cor: cinza



2 420.00€

ELECTR. 1000 BLACK

Cor: preto



2 255.00€

HV 1000V

Carro de ferramentas para eletricista com composição de ferramenta isolada a 1000volts

TABULEIROS



Composição: 43 peças

Tabuleiro com

- Jogo de alicate de pontas, universal e de corte
- Jogo chaves fenda e Philips
- Jogo chaves de caixa com punho
- Busca polos



Tabuleiro com

- Multímetro digital
- Jogo de extensões
- Roquete
- Navalha
- Jogo chaves de caixa 1/2" de 8 a 22mm
- Jogo chaves luneta de 8 a 14mm
- Jogo chaves bocas de 8 a 14mm
- Jogo chaves hexagonais de 4 a 8mm
- Chave ajustável

CARROS



C-6DWB1



C-7DC2B



HV1000V-V	Cor: verde 	1 670.00€
HV1000V-C	Cor: cinza 	1 670.00€

HV1000V-BLACK	Cor: preto 	1 505.00€
----------------------	--	-----------

ELECTR

Carro de ferramentas para eletricitista, composição geral

TABULEIROS

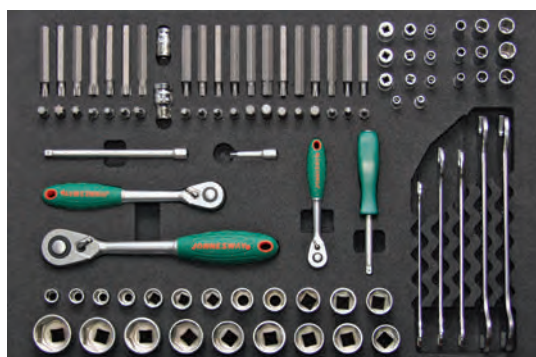
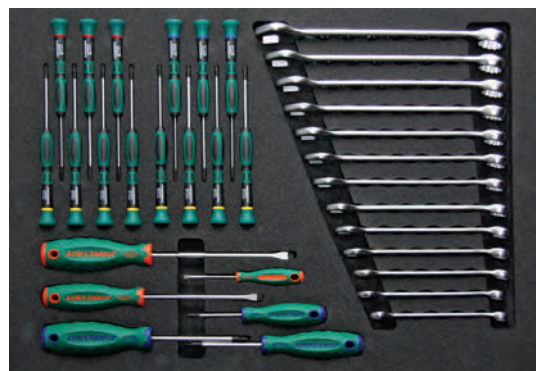

Composição: 144 peças

Tabuleiro com

Jogo alicates universal, de pontas, de corte
Mini alicates
Alicate de descarnar
Alicate de cravar terminais

Tabuleiro com

Jogo chaves mistas de 10 a 22mm,
Jogo chaves de precisão
Chaves fenda e Philips

Tabuleiro com

Jogo de bits com adaptadores
Jogo chaves de boca perfil fino de 10 a 19mm
Jogo chaves caixa 1/2" de 17 a 30mm
Jogo chaves de caixa 3/8" de 11 a 16mm
Jogo de roquetes e extensões

Tabuleiro com

Bandeja magnética
Gambiarras leds
Multímetro digital
X-acto
Tesoura
Raspador com lâminas



C-6DWB5



C-7DC2B



ELECTR-V	Cor: verde 	1 750.00€
ELECTR-C	Cor: cinza 	1 750.00€

ELECTR-BLACK	Cor: preto 	1 550.00€
---------------------	--	-----------



CHAPEIRO 20

Carro de ferramentas para chapeiro

TABULEIROS



Composição: 55 peças
Tabuleiro com
 Lima de chapeiro
 Jogo de martelos chapeiro
 Chaves cavilhas

Tabuleiro com
 Jogo alicates universal, de pontas e de corte
 Desandador de percussão
 Jogo alicates de pressão

Tabuleiro com
 Jogo de ventosas
 Jogo chaves fenda e Philips de pancada
 Jogo de ferramentas para remoção de frisos plásticos

Tabuleiro com
 Jogo encontradores para ferro
 Kit remoção de vidros para brisas



C-4DWA1



C-7DC2B



CHAPEIRO20-V	Cor: verde		1 600.00€
CHAPEIRO20-C	Cor: cinza		1 600.00€

CHAPEIRO20- BLACK	Cor: preto		1 550.00€
--------------------------	------------	--	-----------



CHAPEIRO ALU

Carro de ferramentas para chapeiro

TABULEIROS



Composição: 56 peças
Tabuleiro com
 Lima de chapeiro
 Jogo de martelos chapeiro
 Chaves cavilhas

Tabuleiro com
 Jogo alicates universal, de pontas e de corte
 Desandador de percussão
 Jogo alicates de pressão

Tabuleiro com
 Jogo de ventosas
 Jogo chaves fenda e Philips de pancada
 Jogo de ferramentas para remoção de frisos plásticos

Tabuleiro com
 Jogo encontradores para alumínio
 Kit remoção de vidros para brisas



C-4DWA1



C-7DC2B



CHAPEIROALU-V	Cor: verde		1 635.00€
CHAPEIROALU-C	Cor: cinza		1 635.00€

CHAPEIROALU-BLACK	Cor: preto		1 585.00€
--------------------------	------------	---	-----------



PINTOR20

TABULEIROS



Composição: 55 peças

Tabuleiro com

Jogo de espátulas remoção de frisos
Espelho auxiliar de reparação de mossas
Jogo chaves para remoção de cavilhas e molas

Tabuleiro com

Pistola pintura
Base para lixa
Jogo de 4 espátula
Lixadora orbital
Saca terminais de cabo de baterias

Tabuleiro com

Jogo chaves luneta de 6 a 32mm, X-acto
Jogo chaves fenda e Philips

Tabuleiro com

Jogo de 6 ventosas e acessórios



C-4DWA1



C-7DB2B

PINTOR20-V

Cor: verde



1 580.00€

PINTOR20-C

Cor: cinza



1 580.00€

PINTOR20-BLACK

Cor: preto



1 525.00€

MEC PESADOS

Carro de ferramentas com 7 gavetas + pega + bloco complementar

TABULEIROS

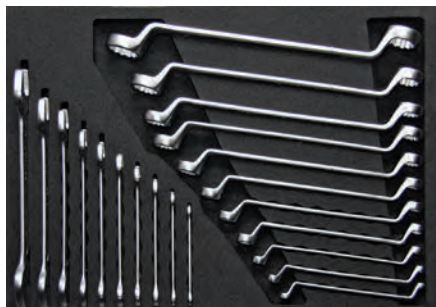

MEC PESADOS 20A

3 350.00€



MEC PESADOS 20B

3 180.00€



Composição: 162 peças

Tabuleiro com

Jogo chaves caixa de 1/2" de 8 a 34mm com roquete e extensão
 Jogo chaves torx macho 1/2" de T30 a T80
 Jogo chaves macho hexagonais de 1/2" de H5 a H19
 Cardan
 Rabo de força

Tabuleiro com

Jogo chaves caixa de impacto longas de 1/2" e 3/4" de 10 a 46mm
 Adaptadores
 Extensão
 Cardan

Tabuleiro com

Jogo de martelos, marreta e alicates

Tabuleiro com

Jogo chaves fenda e Philips de pancada
 Jogo chaves Hexagonais de impacto, chave de filtro

Tabuleiro com

Jogo chaves luneta de 6 a 32mm e Jogo chaves de bocas de 6 a 32mm

Tabuleiro com

Jogo chaves de 3/4" de 19 a 50mm com extensões, adaptadores, cardan e roquete

Tabuleiro com

Jogo chaves mistas de 20 a 46mm

C-SA2

4 650.00€

Armário modular

- Dimensões totais: 2 322x1 980x526mm
- 1 Módulo de armário vertical: 600x526x1980mm
- 1 Módulo 7 gavetas: 861x500x994mm
- 1 Módulo 2 portas: 861x500x994mm
- 2 Armários superiores: 861x300x338mm
- 2 Painéis perfurados: 861x20x338mm
- 1 Tampo madeira: 1 725x480x40mm



C-SA2S

4 500.00€

Armário modular

- Dimensões totais: 2 322x526x1 980mm
- 1 Módulo de armário vertical: 600x526x1 980mm
- 1 Módulo 7 gavetas: 861x500x994mm
- 1 Módulo 2 portas: 861x500x994mm
- 2 Armários superiores: 861x300x338mm
- 2 Painéis perfurados: 861x20x338mm
- 1 Tampo inox: 1 725x480x40mm



C-SA3

6 050.00€

Armário modular

- Dimensões totais: 2 998x526x1 980mm
- 1 Módulo de armário vertical: 600x526x1 980mm
- 1 Módulo 7 gavetas: 861x500x994mm
- 1 Módulo 7 gavetas: 676x500x994mm
- 1 Módulo 2 portas: 861x500x994mm
- 1 Armário superior: 861x300x338mm
- 1 Armário superior: 676x300x338mm
- 2 Painéis perfurados: 861x20x338mm
- 1 Pannel perfurado: 676x20x338mm
- 1 Tampo madeira: 2 404x480x40mm



C-SA3S

5 900.00€

Armário modular

- Dimensões totais: 2 998x526x1 980mm
- 1 Módulo de armário vertical: 600x526x1 980mm
- 1 Módulo 7 gavetas: 861x500x994mm
- 1 Módulo 7 gavetas: 676x500x994mm
- 1 Módulo 2 portas: 861x500x994mm
- 2 Armário superior: 861x300x338mm
- 1 Armário superior: 676x300x338mm
- 2 Painéis perfurados: 861x20x338mm
- 1 Pannel perfurado: 676x20x338mm
- 1 Tampo inox: 2 404x480x40mm

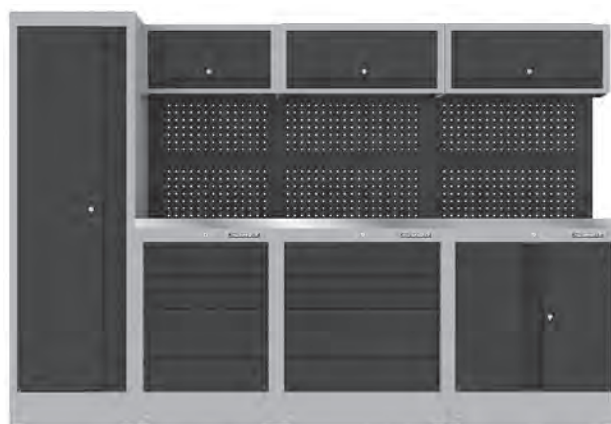

C-SA4S

5 700.00€

Armário modular

Dimensões totais: 2 998x526x1 980mm
 1 Módulo de armário vertical: 600x526x1 980mm
 1 Módulo 7 gavetas: 676x500x994mm
 1 Carrinho 7 gavetas: 671x459x940mm
 1 Módulo 2 portas: 861x500x994mm
 2 Armário superior: 861x300x338mm
 1 Armário superior: 676x300x338mm
 2 Painéis perfurados: 861x20x338mm
 1 Painel perfurado: 676x20x338mm
 1 Tampo aço inox: 2 404x480x40mm



C-SQ2401

1 070.00€

Armário alto para arrumos

Dimensões totais: 600x526x1 980mm
 1 Porta



C-SP3401

295.00€

Armário de topo

Dimensões totais: 861x300x338mm
 Porta basculante



C-SQ3401

1 010.00€

Armário largo com 7 gavetas

Tampo não incluído.

Dimensões totais: 861x500x994mm
 7 Gavetas



C-SQ3402

690.00€

Armário largo com 2 portas

Tampo não incluído.

Dimensões totais: 861x500x994mm
 2 Portas



C-SQ3403

925.00€

Armário multifunções

Tampo não incluído.

Dimensões totais: 861x500x994mm
 1 Alojamento para rolo de papel
 1 Divisão para o lixo
 1 Divisão para arrumos



C-S7DW1

790.00€

Carro vazio para armário oficial

Permite ser arrumado em armário oficial

Dimensões totais: 671x459x940mm
 Peso: 52,4kg
 7 Gavetas



Armários e carros para ferramentas
C-SR3401

90.00€

Conjunto de 2 painéis perfurados

Dimensões totais: 861x20x338mm

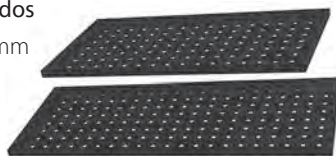
C-SU01

10,20€

Rodapé

Para armário alto.

Comprimento: 500mm

C-SU02

10.20€

Rodapé

É necessário incluir para os módulos de fecho.

Comprimento: 470mm

C-SW01

85.00€

Suporte lateral

É necessário incluir uma unidade para suporte do armário superior quando este ficar na extremidade.

C-SW02

56.00€

Suporte central para união de módulos

É necessário incluir uma unidade por cada 2 módulos.

C-SM

290.00€

Tampo de madeira para armário

Preço por metro

Dimensões totais: 1 000x480x40mm

C-SG

245.00€

Tampo em chapa galvanizada

Preço por metro

Dimensões totais: 1 000x480x40mm

C-SInox

625.00€

Tampo em aço inox liso

Preço por metro

Dimensões totais: 1 000x480x40mm

C-1DM1

355.00€

Gaveta lateral de apoio de laptop/ tablet até 14"

Adicional para carros de ferramentas

Dimensões gaveta: 410x285x70



* Exemplo de aplicação em carro de ferramentas

C-3DW5

765.00€

Carro vazio para ferramenta

Dimensões totais: 670x460x960mm

Peso: 54,2kg

3 Gavetas de 576x380x75mm

1 Arrumos com 2 portas de 603x404x478mm



C-4DWA1 Cor: verde  700.00€

C-4DWA1G Cor: cinza  700.00€

Carro vazio para ferramenta com 4 gavetas

Tampo especial preparado para banca de trabalho

Dimensões totais: 670x460x795mm

2 Gavetas de 579x380x56mm

1 Gaveta de 579x380x123mm

1 Gaveta de 579x380x179mm



C-7DC2B Cor: preto  610.00€

Carro vazio para ferramenta com 7 gavetas

Dimensões totais: 670x460x963mm

5 Gavetas de 576x380x75mm

2 Gavetas de 576x380x154mm

Peso total: 57kg

Capacidade de carga: 140kg/roda

Dimensão rodas: 127x25,5mm



C-6DWB1 Cor: verde  860.00€

C-6DWB1G Cor: cinza  860.00€

Carro vazio para ferramenta com 6 gavetas

Tampo especial preparado para banca de trabalho

Dimensões totais: 670x460x967mm

4 Gavetas de 579x380x56mm

1 Gaveta de 579x380x123mm

1 Gaveta de 579x380x179mm



C-6DWB5 840.00€

Carro vazio para ferramenta com 6 gavetas

Tampo revestido a plástico e suporte para ferramenta

Dimensões totais: 670x460x967mm

4 Gavetas de 579x380x56mm

1 Gaveta de 579x380x123mm

1 Gaveta de 579x380x179mm



C-7DS1 1 130.00€

Carro vazio para ferramenta com 7 gavetas

Tampo em aço

Dimensões totais: 710x500x967mm

1 Painel lateral perfurado

1 Painel lateral para compartimentos de arrumos

4 Rodas, 2 direcionais com travão

Peso total: 74,5kg

Capacidade de carga: 160kg/roda

* As caixas laterais são opção



C-7DW9 999.00€

Carro vazio para ferramenta com 7 gavetas

Sistema de segurança, abertura de 1 só gaveta

Dimensões totais: 670x460x967mm

5 Gavetas de 576x380x75mm

2 Gavetas de 576x380x154mm

Peso total: 74,5kg

Capacidade de carga: 75kg/roda

Dimensão rodas: 127x50,8mm



C-7 TOWER

1 350.00€

Carro vazio com 13 gavetas

Dimensões totais: 670x460x1 334mm

5 Gavetas de 576x380x75mm

2 Gavetas de 576x380x154mm

Caixa superior

3 Gavetas de 170x275x50mm

2 Gavetas de 569x275x50mm

1 Gaveta de 569x275x75mm



C-13DW53

2 200.00€

Carro grande vazio para ferramenta com 13 gavetas

Dimensões totais: 1 358x460x1 150mm

10 Gavetas de 576x380x75mm

2 Gavetas de 579x380x154mm

1 Gaveta de 1 216x380x173mm



C-A16W

555.00€

Armário com 7 gavetas

Inclui 2 rodas para acoplamento aos carros C-7/ C-6

5 Gavetas de 288x380x75mm

2 Gavetas de 288x380x154mm



C-10DW42

1 800.00€

Carro grande vazio para ferramenta com 10 gavetas

Dimensões totais: 1 070x460x981mm

1 Compartimento arrumação de 316x404x1 150mm

5 Gavetas de 288x380x75mm

2 Gavetas de 576x380x154mm

1 Gaveta de 288x380x154mm

1 Gaveta de 576x380x154mm

1 Gaveta de 928x380x173mm



C-A17W

Cor: verde



335.00€

C-A17WG

Cor: cinza



335.00€

Armário com 1 porta

Inclui 2 rodas para acoplamento aos carros C-7/ C-6



C-T3

575.00€

Carro vazio para ferramenta com 3 gavetas

Tampo de abrir

Dimensões totais: 780x520x884mm



C-T12

252.00€

Carro com 3 prateleiras

Dimensões totais: 716x410x880mm

Peso: 20kg

Rodas: 4 (2 fixas+2 direcionais)



C-5CD

340.00€

Caixa metálica vazia para ferramenta com 5 malas

Dimensões totais: 431x307x381mm

5 Malas de 48x245x55mm



C-6DA4

365.00€

Caixa metálica vazia para ferramenta com 6 gavetas

Compartimento no topo com várias divisórias

Dimensões totais: 660x307x374mm

3 Gavetas de 172x270x41mm

2 Gavetas de 572x270x31mm

1 Gaveta de 572x270x65mm



C-6DA494

890.00€

Caixa de ferramenta com 6 gavetas - 98 peças

Compartimento no topo com várias divisórias

Dimensões totais: 660x307x374mm

Composição:

AG10002SC

D376514SC

R4811SC

P0813SC

S04H5129SC

V11011SC

W25117SC

W27AT02SC



Malas vazias e complementos para carros

C-3DH5

177.00€

Caixa metálica vazia para ferramenta com 3 gavetas

Compartimento no topo

Dimensões totais: 535x220x290mm

3 Gavetas de 505x195x45mm



C-3DH2

96.50€

Caixa metálica vazia para ferramenta com 5 compartimentos

Dimensões totais: 470x240x220mm



C-3DH262

415.00€

Caixa metálica para ferramenta com 5 compartimentos - 62 peças

Dimensões totais: 470x220x350mm

Composição

P106 Alicates de corte

P116 Alicates de pontas

P087 Alicates universais

D70 Jogo de 6 chaves fenda/ phillips

W26 Jogo de 18 chaves mistas

R2904 Roquete de 1/2"

S04H41 Jogo de 18 chaves de caixa

S15H472 Adaptador

S24H4 Extensões

S22H41450 Cabo articulado 450mm

S23H41300 Cabo T correção 300mm

S21H4150 Extensão

S17H4121 Chave de velas 21mm

H03SM109S Jogo de chaves hexagonais



C-A456 82.00€

Tampo plástico para carros de ferramenta

Aplicável aos carros C-4/ C-6 e C-7



C-A9 62.00€

Base para torno e suporte para rolo de papel



C-A27 58.00€

Tampo em acrílico resistente ao impacto para carros de ferramentas

Aplicável somente aos carros C-5DW/ C-6DW e C-7DW



C-7DW1-TS 119.00€

Tampo completo para carros de ferramentas

Aplicável somente aos carros C-5DW/ C-6DW e C-7DW

Composição

1 Tampo acrílico resistente ao impacto

1 Base metálica de apoio

1 Revestimento EVA de 2mm



C-A31 20.50€

Suporte lateral para chaves em T para fixação



C-A3 Cor: verde 23.00€

Pega para carro de ferramenta

Aplicável a C-4DW; C-6DW e C-7DW



C-A3-B Cor: preto 23.00€

Pega para carro de ferramenta

Aplicável a C-7DB2 e C-7DC2

C-A3G Cor: cinza 23.00€

Pega para carro de ferramenta

Aplicável a C-4DW; C-6DW e C-7DW

C-BS

Jogo de calhas direita e esquerda, para gavetas de carros e caixas

Ref.	Aplicação	Preço
C-BS Kit1	Carros: C-4DW/ C-5DW/ C-6DW/ C-7DW	18.50€
C-BS Kit2	Caixas: C-6DA4	14.00€
C-BS Kit3	Carros: C-10DW/ C-13DW	22.00€



C-PC

Canhão de fechadura

Ref.	Aplicação	Preço
C-PC1	C-6DA4	7.90€
C-PC2	C-5/ C-6/ C-7/ C-10/ C-13	8.30€
C-PC3	C-4	13.20€



C-PC4 14.00€

Canhão de fechadura para chaves tubulares

Inclui 2 chaves.



C-WHEEL

Rodas

Ref.	Tipo	Aplicação carro	Preço
C-WHEEL1	fixa	C-6/ C-7	18.00€
C-WHEEL2	travão	C-6/ C-7	24.50€
C-WHEEL5	fixa	C-4/ C-5/ C-7DB2	16.70€
C-WHEEL6	travão	C-4/ C-5/ C-7DB2	23.50€
C-WHEEL8	fixa	C-T3/ C-/12	14.30€
C-WHEEL9	travão	C-T3/ C-/12	15.90€



C-A

Torno de bancada

Ref.	Abertura (mm)	Peso (kg)	Preço
C-A7*	76	6	104.00€
C-A8*	101	7,25	127.00€
C-A10	127	10,2	165.00€
C-A11	152	14	195.00€
C-A12	203	18	255.00€
C-A13	254	24	335.00€



* Aplicável em carro de ferramenta (necessário suporte C-A9)

Malas vazias e complementos para carros

C-B



Torno de bancada com dupla rotação

Rotação 360° da base do torno

Rotação 360° da cabeça do torno

Ref.	Abertura (mm)	Peso (kg)	Preço
C-B5	127	17	203.00€

C-A2501S

26.00€

Conjunto de caixas plásticas para gavetas de carros de ferramenta

Composição

12 Caixas 93x93x43mm

4 Caixas 283x93x43mm

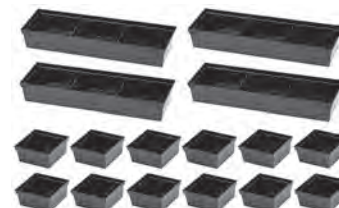

C-APB

27.50€

Conjunto de caixas plásticas para gavetas de carros de ferramenta

Composição

8 Caixas 283x93x43mm

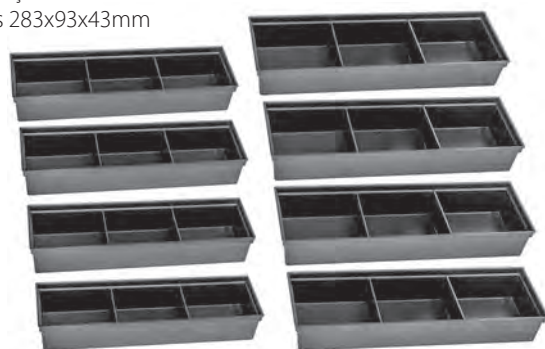



JONNESWAY®

de Profissionais para Profissionais

VDE Prüf- und Zertifizierungsinstitut

ZEICHENGENEHMIGUNG MARKS APPROVAL

Jonnesway Enterprise
Co. Ltd.
6F-9, No.51, Sec.2, Keelung Rd.
110 TAIPEI
TAIWAN

ist berechtigt, für ihr Produkt /
is authorized to use for their product

Kabelmesser
Cable knives

die hier abgebildeten markenrechtlich geschützten Zeichen
für die ab Blatt 2 aufgeführten Typen zu benutzen /
the legally protected Marks as shown below for the types referred to on page 2 ff.



Geprüft und zertifiziert nach /
Tested and certified according to

DIN EN 60900 (VDE 0682-201):2013-04; EN 60900:2012

Das Produkt entspricht den Anforderungen des deutschen Produktsicherheitsgesetzes (ProdSG)
hinsichtlich der Gewährleistung von Sicherheit und Gesundheit.
The product covers the requirements of the German Act "Produktsicherheitsgesetz (ProdSG)"
regarding the ensurance of safety and health.



Befristet zum / valid until: 2020-02-29

Aktenzeichen: 5010169-3940-0010 / 223208

VDE Prüf- und Zertifizierungsinstitut GmbH
VDE Testing and Certification Institute
Zertifizierungsstelle / Certification

File ref.:
Ausweis-Nr. 40035280 Blatt 1
Certificate No. Page

Weitere Bedingungen siehe Rückseite und Folgeseiten /
Further conditions see reverse and following pages
Offenbach, 2012-06-26
(letzte Änderung / updated 2016-05-25)

A. Fabian
VDE Zertifikate sind nur gültig bei Veröffentlichung unter:
VDE certificates are valid only when published on:

<http://www.vde.com/zertifkat>
<http://www.vde.com/certificate>

VDE



VDE Prüf- und Zertifizierungsinstitut

ZEICHENGENEHMIGUNG MARKS APPROVAL

Jonnesway Enterprise
Co. Ltd.
6F-9, No.51, Sec.2, Keelung Rd.
110 TAIPEI
TAIWAN

ist berechtigt, für ihr Produkt /
is authorized to use for their product
Zusammensetzbares Werkzeug
Assembly tool

die hier abgebildeten markenrechtlich geschützten Zeichen
für die ab Blatt 2 aufgeführten Typen zu benutzen /
the legally protected Marks as shown below for the types referred to on page 2 ff.



Geprüft und zertifiziert nach /
Tested and certified according to

DIN EN 60900 (VDE 0682-201):2013-04; EN 60900:2012

Das Produkt entspricht den Anforderungen des deutschen Produktsicherheitsgesetzes (ProdSG)
hinsichtlich der Gewährleistung von Sicherheit und Gesundheit.
The product covers the requirements of the German Act "Produktsicherheitsgesetz (ProdSG)"
regarding the ensurance of safety and health.



Befristet zum / valid until: 2020-04-30

Aktenzeichen: 5010169-3940-0019 / 223207

VDE Prüf- und Zertifizierungsinstitut GmbH
VDE Testing and Certification Institute
Zertifizierungsstelle / Certification

File ref.:
Ausweis-Nr. 40035283 Blatt 1
Certificate No. Page

Weitere Bedingungen siehe Rückseite und Folgeseiten /
Further conditions see reverse and following pages
Offenbach, 2012-06-26
(letzte Änderung / updated 2016-06-20)

M. Tschudi
VDE Zertifikate sind nur gültig bei Veröffentlichung unter:
VDE certificates are valid only when published on:

<http://www.vde.com/zertifkat>
<http://www.vde.com/certificate>

VDE





JONNESWAY®

Ferramenta Manual



**Tabuleiros para
composição
de carros**



Chaves



**Ferramenta
de aperto**



Martelos



Alicates



Diversos



AG010002SP

52.00€

Jogo de 4 alicates de freios

Composição:

AG010002 Alicates de freios interiores

AG010005 Alicates de freios interiores de ponta curva

AG010008 Alicates de freios exteriores

AG010011 Alicates de freios exteriores de pontas curvas 90°

A



AG010026SP

60.00€

Jogo de martelos e talhadeiras

Composição:

M09300 Martelo tipo alemão 300g

M11035 Martelo com batentes de borracha 400g

M61 Jogo de 3 talhadeiras

A



AG010150SC

114.00€

Jogo de 8 alicates de freios

Composição:

4 Alicates de pontas direitas

4 Alicates de pontas curvas

B



AG10001SP

113.00€

Jogo de machos e caçonetes

Composição:

17 Machos manuais: M3 a M12

17 Caçonetes: M3 a M12

1 Porta caçoneto

1 Desandador de machos

1 Punho desandador

B



AI10001SP

219.00€

Jogo de ferramentas para substituição de válvulas da cabeça do motor

Composição:

AN010064 Compressor de válvulas da cabeça do motor

AI020056 Alicates para vedantes de válvulas

AI020099 Adaptador de mola de válvula

AI020100 Suporte de válvulas

AI010012A Removedor de pastilhas de válvula

B



AI10002SP

165.00€

Jogo de ferramentas para substituição da polie da correia da cambota

Composição:

AE310030 Saca de 2 pernas

AE10035-1 Complemento para 3 pernas

AN010038 Saca vedante

AI020087A Saca polie da cambota

B



AI10003SP
138.00€
Jogo de chaves de copo para filtros

Composição:

- 9 Chaves de copo para filtros
- 14 Chaves para bujão do carter
- 1 Chave de filtros

B

Description			
○ 8mm	BMW, Ford	△ 10mm	Renault
○ 9mm	General Motor	T-Bar To Drive	
○ 10mm	Ford	30-160mm Oil Filter Chain 3/8" Oil	
○ 12mm	Fiat, Lancia, Peugeot	Filter Cap Wrench	
○ 14mm	Mercedes, Lancia	93mm-15	GM, Nissan, Volvo, Mazda, Audi, VW, etc.
○ 17mm	BMW, Austin, Audi, VW	76mm-14	VW, Porsche, Mercedes, BMW, Toyota
○ 3/8"	General Motor	75.6mm-14	Mazda, General Motor
□ 10mm	BMW, Renault, Toyota	38mm	etc Diesel Engine
□ 8mm	Citroen, Peugeot, Renault, Talbot, Volvo	36mm	Benz, VW, BMW/M52, M60, M73
□ 11mm	Ford	32mm	GM, Saab, Saturn
□ 13mm	Nissan, Subaru	30mm	General Motor
□ 3/8"	Honda, Mazda, Renault, Saab, Volvo	27mm	Mercedes
□ 7mm	General Motor	24mm	BMW/ 5 & 7 séries

AN10002SP
214.00€
Jogo de 42 peças de ferramenta para travões

Este tabuleiro ocupa meia gaveta do carro de ferramentas.

C

D70105SP
42.00€
Jogo de 5 chaves fenda/ phillips impacto

Composição/ medidas em mm:

- | | | | |
|-------------|--------------------|-------------|--------------------|
| D70S | 3 Chaves de fenda: | D70P | 2 Chaves phillips: |
| | 6,5x125 | | PH 2x100 |
| | 8x150 | | PH 3x150 |
| | 9,5x175 | | |

A

D71PP08SP
38.50€
Jogo de 8 chaves fenda/ phillips

Composição/ medidas em mm:

- | | | | |
|-------------|--------------------|-------------|--------------------|
| D71S | 4 Chaves de fenda: | D71P | 4 Chaves phillips: |
| | 6,5x38 | | 2x38 |
| | 4x80 | | 1x80 |
| | 5,5x125 | | 2x100 |
| | 6,5x150 | | 3x150 |

A

D725N08SP
79.00€
Jogo de 8 chaves de caixa de punho

Composição:

Chaves de 6 a 13mm

C

H10MB08SP
46.00€
Jogo de 8 chaves macho hexagonal com extremidade esférica e punho

Composição/ medidas em mm:

- | | | |
|--------------|---------|--------|
| H10MB | 2x100 | 5x150 |
| | 2,5x100 | 6X150 |
| | 3x100 | 8X200 |
| | 4x100 | 10X200 |

B

H10MT08SP
46.00€
Jogo de 8 chaves torx duplas tamperproof com punho

Composição/ medidas em mm:

- | | | |
|--------------|---------|---------|
| H10MT | T10x100 | T27x150 |
| | T15x100 | T30X150 |
| | T20x100 | T45X200 |
| | T25x100 | T50X200 |

B

H20MT08SP
49.00€
Jogo de 8 chaves torx duplas de punho

Composição/ medidas em mm:

- | | | |
|--|---------|---------|
| | T10x110 | T27x145 |
| | T15x120 | T30X155 |
| | T20x125 | T45X185 |
| | T25x135 | T50X205 |

B

M09513SP 86.00€

Jogo de martelos e punções

Composição:

- M07016 Martelo com batentes de plástico
- M09500 Martelo de mecânico tipo "alemão"
- M63M106S Jogo saca troços cromados
- M64M105S Jogo punções e escopros cromados

A



M645114SP 86.50€

Jogo de serra, chave inglesa, punções e escopros

Composição:

- M63 6 Punções
- M64 4 Escopros
- W27AS10 Chave inglesa
- MHS100AG Serra

B



MTC101SP 220.00€

Jogo de ferramenta de medição

Composição/ medidas em mm:

- Paquímetro digital 150
- Esquadro metálico 300
- Régua metálica 300
- Compasso 200
- Micrómetro 0-25
- Micrómetro 25-50
- Lapiseira

B



P018SP1 67.00€

Jogo de 3 alicates e 7 chaves hexagonais

Composição:

- P018 Alicates universal
- P038 Alicates de corte diagonal
- P068 Alicates de pontas
- H01SM109S Chaves hexagonais

A



P018SP 56.00€

Jogo de 3 alicates

Composição:

- P018 Alicates universal
- P038 Alicates de corte diagonal
- P068 Alicates de pontas

A



P04704SP 65.00€

Jogo de 4 alicates de corte

Não utilizar em metal.

A



P0803SP 53.00€

Jogo de 3 alicates isolados

Composição:

- P087 Alicates universal
- P097 Alicates de corte diagonal
- P118 Alicates de pontas

A



P0903SP 62.00€

Jogo de 3 alicates isolados

Composição:

- P0118 Alicates universal
- P0918 Alicates de corte diagonal
- P1118 Alicates de pontas

A



P2710SP 37.00€

Jogo de 2 alicates

Composição:

- P2710 Alicates ajustável
- P32M10A Alicates de pressão

A



P2803SP

58.00€

Jogo de 2 alicates e chave inglesa

Composição:

- W27AS10 Chave inglesa
- P2810 Alicates ajustável
- P32M10A Alicates de pressão

A



S03A4122SP

93.00€

Jogo de 22 chaves de impacto 1/2"

Composição/ medidas em mm:

- S03A4 Chaves: 10; 11; 12; 13; 14; 16; 17; 19; 21; 22 e 24
- S03AD4 Chaves: 10; 11; 12; 13; 14; 16; 17; 19; 21; 22 e 24

A



S04H2125SP

56.00€

Jogo de chaves de caixa com 24 peças de 1/4"

Composição/ medidas em mm:

- R3702 Roquete de 48 dentes
- S04H2 Chaves de caixa: 4; 5; 5,5; 6; 7; 8; 9; 10; 11; 12 e 13
- S04HD2 Chaves de caixa: 5; 6; 7; 8; 9; 10; 11; 12 e 13
- S24H250 Extensão 50
- S24H2150 Extensão 150
- S26H2150 Punho

A



S04H3157SP

127.00€

Jogo de 8 chaves de caixa com 56 peças de 1/4" e 3/8"

Composição/ medidas em mm:

- R3702 Roquete 1/4" de 48 dentes
- S04H2 Chaves 1/4": 4; 4,5; 5; 5,5; 6; 7; 8; 9; 10; 11; 12 e 13
- S04HD2 Chaves 1/4": 8; 10; 12 e 13
- S09H2 Bits hexagonais: 3; 4; 5 e 6
- S07H2 Bits torx: T10; T15; T20; T25; T27 e T30
- S10H2 Bits fendas: 4; 5,5 e 7
- S11H2 Bits phillips: PH1; PH2 e PH3
- S24H2 Extensões
- Adaptador de extensão
- S16H302 Adaptador universal
- Punho
- R3703 Roquete 3/8" de 48 dentes
- S04H3 Chaves 3/8": 14; 15; 17; 18; 19; 20; 22 e 24
- S04HD3 Chaves 3/8": 14; 15 e 17
- S17H3 Chaves de velas: 16 e 21
- S24H3 Extensões
- Adaptador extensão 3/8" - 1/2"
- S15H356 Adaptador universal

B



S04H3536SP

108.00€

Jogo de chaves de caixa e chaves mistas com 36 peças de 3/8"

Composição/ medidas em mm:

- R3503 Roquete de 72 dentes
- S04H3 Chaves de caixa: 6 a 22
- S24H3 Extensões
- Adaptador de extensão 1/2" - 3/8"
- S17H3 Chaves de velas: 16 e 21
- S15H356 Adaptador universal
- W26 Chaves mistas boca/ luneta: 7 a 17

B



S04H4125SP

97.00€

Jogo de chaves de caixa com 25 peças de 1/2"

Composição/ medidas em mm:

- R3704 Roquete de 48 dentes
- S04H4 Chaves: 10; 11; 12; 13; 14; 15; 16; 17; 18; 19; 20; 21; 22; 23; 24; 27; 30 e 32
- S24H4 Extensões
- S17H4 Chaves de velas: 16 e 21
- S23H4125 Cabo "T" corrediço
- S15H472 Adaptador universal

B



S04H4131SP

130.00€

Jogo de chaves e roquete com 31 peças de 1/2"

Composição/ medidas em mm:

- Roquete de 72 dentes
- Chaves de caixa: 10 a 32
- Chaves de velas: 16 e 21
- Cardan
- Extensão de 125
- Extensão de 250
- Cabo "T" corrediço de 250
- Bits hexagonais de 5; 6; 8; 10 e 12

C



S04H4524SP

110.00€

Jogo de chaves sextavadas com 24 peças de 1/2"

Composição/ medidas em mm:

- R3704 Roquete de 48 dentes
- S04H4 Chaves: 10; 11; 12; 13; 14; 15; 16; 17; 18; 19; 20; 21; 22; 23; 24; 27; 30 e 32
- S24H4 Extensões 5" e 10"
- S15H472 Adaptador universal
- S22H41375 Punho flexível 15"
- S23H41300 Cabo "T" corrediço

B



S04H4726SP

115.00€

Jogo de chaves de caixa com 26 peças de 1/2"

Composição/ medidas em mm:

- R3704 Roquete de 48 dentes
- S04H4 Chaves de caixa: 12; 13; 14; 15; 16; 17; 18; 19; 20; 21; 22; 23; 24; 25; 26; 27; 28; 30 e 34
- S24H4 Extensões 5" e 10"
- S17H4116 Chave de velas 16
- S15H472 Adaptador universal
- S23H41300 Cabo "T" corrediço
- S41H4 Manivela de punho metálico

B



S04H4728SP

107.00€

Jogo de chaves de caixa sextavadas com 28 peças de 1/2"

Composição/ medidas em mm:

- R3704 Roquete de 48 dentes
- S04H4 Chaves de caixa: 8; 9; 10; 11; 12; 13; 14; 15; 16; 17; 18; 19; 20; 21; 22; 23; 24; 25; 26; 27; 28; 30; 32 e 34
- S24H4250 Extensão 10"
- S15H472 Adaptador universal
- S23H41300 Cabo "T" corrediço

B



S06H427SP

92.00€

Jogo de chaves de caixa bits com 27 peças de 1/2" e 3/8"

Composição:

- S09H4 Bits hexagonais de 1/2"
- S49H4 Bits estriados de 1/2"
- S09H3 Bits hexagonais de 3/8"

A



S09H4118SP

70.00€

Jogo de chaves de caixa bits hexagonais com 18 peças de 1/2"

Composição:

- Chaves 55mm: H5; H6; H7; H8; H10; H12; H14; H17 e H19
- Chaves 100mm: H5; H6; H7; H8; H10; H12; H14; H17 e H19

A



S29H4140SP

50.00€

Jogo 40 bits de 3/8" para quadra de 1/2" e 3/8"

Composição:

- Bits hexagonais
- Bits torx
- Bits estriados
- Porta bits

A



V1311SP 147.00€

Jogo de alicates de cravar e descarnar

Composição:

V1311 Alicates de cravar terminais isolados e não isolados

V1401 Alicates de descarnar fios

AG010031A Pesca magnético com espelho

Teste para circuitos

Kit com 60 terminais

B



W23108SP 63.00€

Jogo de 8 chaves de luneta 75°

Composição/ medidas em mm:

W23 Chaves: 6x7; 8x9; 10x11; 12x13; 14x15; 16x17; 18x19 e 20x22

A



W24A109SP 153.00€

Jogo de 9 chaves de luneta aberta flexível

Composição/ medidas em mm:

W24A Chaves: 8x8; 10x10; 11x11; 12x12; 13x13; 14x14; 17x17; 19x19 e 22x22

A



W25110SP 60.00€

Jogo de 10 chaves de bocas

Composição/ medidas em mm:

W25 Chaves: 6x7; 8x9; 10x11; 12x13; 14x15; 16x17; 18x19; 21x23; 24x27 e 30x32

A



W26112SP 58.00€

Jogo de 12 chaves mistas de boca/ luneta

Composição/ medidas em mm:

W26 Chaves: 8; 9; 10; 11; 12; 13; 14; 15; 16; 17; 19 e 22

A



W26116SP 73.00€

Jogo de 16 chaves mistas de boca/ luneta

Composição/ medidas em mm:

W26 Chaves: 6; 7; 8; 9; 10; 11; 12; 13; 14; 15; 16; 17; 18; 19; 22 e 24

B



W45112SP 148.00€

Jogo de 12 chaves mistas de boca/ roquete de 72 dentes

Composição/ medidas em mm:

W45 Chaves: 8 a 19

A



W47108SP 80.00€

Jogo de 8 chaves de luneta angular com roquete

Composição/ medidas em mm:

W47 Chaves: 6x7; 8x9; 10x11; 12x13; 14x15; 16x18; 17x19 e 21x22

A



W60115SP 170.00€

Jogo de 15 chaves de boca/ roquete reversível de 72 dentes

Composição/ medidas em mm:

W60 Chaves: 9 a 19
Adaptadores de 1/4"; 3/8" e 1/2"
Porta bits de 10

B



W70A118S 265.00€

Jogo de chaves em "T" com roquete articulado

Composição/ medidas em mm:

W60 Chave em "T" de 300
Chave em "T" de 50
Chave com roquete de 72 dentes
Extensão de 3"
Extensão de 6"
Adaptador 3/8" (F)x3/8" (F)

B



Tabuleiros de ferramenta para carros

Tabuleiros em espuma de alta densidade EVA

JA-C131SV

645.00€

Gaveta para serviço em pneus (gaveta completa)

Composição:

- JAI-0924 Pistola pneumática de 1/2"
- JAR-6309A Roquete pneumático de 1/2"
- JAG-0906R Retificadora pneumática de 1/4"
- Chaves de impacto longas de 1/2"
- Chaves de impacto de 1/2"
- Adaptador de 3/8"-1/2"
- Adaptador de 1/2"-3/8"
- Adaptador de 1/2"-3/4"
- Cardan de 1/2"
- Extensões de 1/2"

D



D71157SV

208.00€

Gaveta com chaves de fenda/ phillips, alicates e bits (gaveta completa)

Composição/ medida em mm:

- Chaves de fenda: 6,5x38; 4x80; 5,5x125 e 6,5x150
- Chaves phillips: PH2x38; PH1x80; PH2x100 e PH3x150
- Chaves de fenda/pancada: 6,5x125; 8x150 e 9,5x175
- Chaves phillips/pancada: PH2x100 e PH3x150
- Bits hexagonais: 4; 5; 6; 7; 8; 10 e 12 de 30 e 75mm de comprimento
- Bits torx: T20; T25; T30; T40; T45; T50 e T55 de 30 e 75mm de comprimento
- Bits XZN: M5; M6; M8; M10 e M12 de 30 e 75mm de comprimento
- Porta bits de 3/8" e 1/2"
- Alicates de freios

D

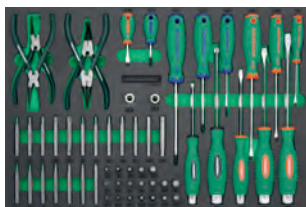

D737128SV

202.00€

Gaveta com chaves de fenda/ phillips (gaveta completa)

Composição:

- D71PP08SP Jogo de chaves de fenda/ phillips
- D70105SP Jogo de chaves de fenda/ phillips pancada
- M645114SP Jogo de serra, chave inglesa, punções e escopros

D



D737134SV

198.00€

Gaveta com chaves de fendas/ phillips (gaveta completa)

Composição:

- D3750P065S Jogo de chaves de precisão
- D3750T08S Jogo de chaves de precisão
- D70105SP Jogo de chaves de fenda/ phillips pancada
- D71PP08SP Jogo de chaves de fenda/ phillips
- W43A106S Jogo de chaves de caixa flexível
- W43A0607 Chave flexível 06x07

D



H10121SV

165.00€

Gaveta com chaves macho hexagonais de punho, talhadeiras e martelos (gaveta completa)

Composição:

- H10MB08S Jogo de chaves duplas hexagonais de punho
- H10MT08S Jogo de chaves duplas torx tamperproof de punho
- AG010026S Jogo de martelos e talhadeiras

D



P82714SV

260.00€

Gaveta com alicates (gaveta completa)

Composição:

- P018SP Jogo de alicates
- P2710SP Jogo de alicates
- AG010002SP Jogo de alicates de freios
- P71 Jogo de mini alicates

D



P82736SV

280.00€

Gaveta com alicates e bits de caixa (gaveta completa)

Composição:

- S06H427SP Jogo de chaves de caixa bits de 1/2" e 3/8"
- AG010002SP Jogo de alicates de freios
- P018SP Jogo de alicates
- P2710SP Jogo de alicates

D



S04H2184SV

199.00€

Gaveta com 74 peças de 1/4" (gaveta completa)

Composição:

Roquete de 1/4"
 Chaves de caixa de 1/4": 4 a 14mm
 Bits de caixa hexagonais de 1/4": H2 a H6
 Adaptador 3/8"(F) x 1/4" (M)
 Adaptador 1/4" (M) x 3/8" (F) para cabo "T" corrediço
 Cardan de 1/4"
 Extensões de 1/4": 100mm e 150mm
 Manivela 1/4": 150mm
 Cabo "T" corrediço de 1/4": 130mm
 Punho de 1/4" com função fixa/cardan 280mm
 Extensão flexível de 1/4": 145mm
 Bits phillips, fenda, pozidrive, hexagonais, torx
 Chaves de precisão fenda/ phillips
 Chaves de fenda/ impacto 9,5x200mm e 9,5x300mm
 Chave de fenda 5x150mm
 Chave de fenda isolada 1000V 5,5x125mm

D

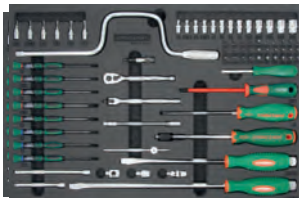

S04H3194SV

242.00€

Gaveta com 94 peças de 1/4" e 3/8" (gaveta completa)

Composição:

Roquete de 1/4"
 Chaves de caixa de 1/4": 5 a 14mm
 Bits de caixa fenda de 1/4": 3,5; 5,5 e 7mm
 Bits de caixa hexagonais de 1/4": H3, H4, H5, H6 e H7
 Bits de caixa phillips de 1/4": PH1; PH2 e PH3
 Bits de caixa torx interior de 1/4": E4; E5; E6; E7 e E8
 Bits de caixa torx de 1/4": T10; T15; T20; T25; T30; T35 e T40
 Punho de 1/4" com função fixa/ cardan 280mm
 Bits torx tamperproof com encaixe de 1/4": T7 a T40
 Bits phillips com encaixe de 1/4": PH1; PH2 e PH3
 Cabo "T" corrediço de 1/4": 115mm
 Extensão de 1/4": 150mm
 Cardan de 1/4"
 Bits e porta bits de 1/4"
 Bit torx tamperproof de 3/8": T55
 Roquete de 1/4" de 36 dentes
 Adaptador 3/8" x 1/4"
 Chaves caixa 3/8": 7 a 22mm
 Chaves torx interior 3/8": E10; E12 e E14
 Chave torx 3/8": T40
 Bits caixa XZN 3/8": M6; M8 e M10
 Extensões 3/8": 75mm e 150mm
 Roquete e roquete flexível de 3/8" com 36 dentes
 Cardan de 3/8"
 Adaptador 1/4" (F) x 3/8" (M)

D

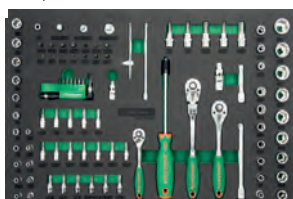

Tabuleiros de ferramenta para carros

Tabuleiros em espuma de alta densidade EVA

S04H42165SV

260.00€

Gaveta com 65 peças de 1/4" e 1/2" (gaveta completa)

Composição:

Roquete de 1/4" de 48 dentes
 Chaves de caixa 1/4": 4 a 13mm
 Chaves de caixa longas de 1/4": 5 a 13mm
 Extensões de 1/4": 50mm e 150mm
 Punho de 1/4"
 Roquete de 1/2" com 48 dentes
 Chaves de caixa 1/2": 10 a 32mm
 Chaves de velas 1/2": 16 e 21mm
 Extensões de 1/2": 125mm e 250mm
 Cabo "T" corrediço
 Cardan de 1/2"
 Chaves mistas de 6 a 24mm

D



S04H4295SV

265.00€

Gaveta com chaves de caixa e roquete (gaveta completa)

Composição:

S04H2125SP Jogo de chaves de caixa com 25 peças de 1/4"
 S04H4131SP Jogo de chaves de caixa com 31 peças de 1/2"
 S29H4140SP Jogo de 40 bits de 1/2" e 3/8"

D



S04H46121SV

335.00€

Gaveta com chaves de caixa e roquete (gaveta completa)

Composição:

S04H3157SP Jogo de chaves de caixa com roquete de 1/4" e 3/8"
 S04H4125SP Jogo de chaves de caixa com roquete de 1/2"
 S29H4140SP Jogo de 40 bits de 1/2" e 3/8"

D



Tabuleiros de ferramenta para carros

Tabuleiros em espuma de alta densidade EVA



W23559SV

240.00€

Gaveta com chaves de fenda/ phillips/ luneta e alicates (gaveta completa)

Composição:

D71PP08SP Jogo de chaves fenda e phillips

W23108SP Jogo de chaves luneta 75°

P0903SP Jogo de alicates

S29H4140SP Jogo de bits de 1/2" e 3/8"

D



W26134SV

255.00€

Gaveta com chaves de luneta/ mistas/ alicates (gaveta completa)

Composição:

W23108SP Jogo de chaves luneta 75°

P0903SP Jogo de alicates

W26112SP Jogo de chaves mistas (boca/ luneta)

H01SM109S Jogo de chaves hexagonais

P28210 Alicata ajustável

P32M10A Alicata de pressão

D



W2623431SV

228.00€

Gaveta com chaves de luneta e mistas (gaveta completa)

Composição:

W23108SP Jogo de chaves luneta 75°

W24106S Jogo de chaves luneta aberta

W26116SP Jogo de chaves mistas boca / luneta

AI050077 Cinta para filtros óleo

D



W26315SV

380.00€

Tabuleiro com 15 chaves mistas (gaveta completa)

Composição:

W26 20; 21; 23; 25; 26; 27; 28; 29; 30; 32; 36; 38; 41; 46 e 50mm

D



D70105KV

48.50€

Tabuleiro com 5 chaves pancada fenda/ phillips (1/3 de gaveta)

Composição:

D70S6125 Chave fenda 6,5x125mm

D70S8150 Chave fenda 8x150mm

D70S9175 Chave fenda 9,5x175mm

D70P2100 Chave phillips PH2x100mm

D70P3150 Chave phillips PH3x150mm

A



D70PS119KV

82.00€

Tabuleiro com 5 chaves fenda/ phillips e desandador (1/3 de gaveta)

Composição:

3 Chaves phillips pancada: PH1x75; PH2x100 e PH3x125

2 Chaves fenda pancada: 6,5x150 e 9,5x200

1 Desandador de percussão com 13 bits

A



D71PP08KV

46.50€

Tabuleiro com 8 chaves fenda/ phillips (1/3 de gaveta)

Composição:

D71S Jogo de 4 chaves fenda
6,5x38; 4x80; 5,5x125 e 6,5x150mm

D71P Jogo de 4 chaves phillips
PH1X80; PH2X38; PH2x100 e PH3x150mm

A



H10MB08KV

51.50€

Tabuleiro com 8 chaves hexagonais de punho (1/3 de gaveta)

Composição:

H10MB Jogo de 8 chaves macho
2x100; 2,5x100; 3x100; 4x100; 5x150; 6x150, 8x200
e 10x200mm

A



H10MT08KV

53.00€

Tabuleiro com 8 chaves torx tamperproof de punho (1/3 de gaveta)

Composição:

H10MT Jogo de 8 chaves torx
T10x100; T15x100; T20x100; T25x100; T27x150;
T30x150; T45x200 e T50x200mm

A



M09103KV

65.80€

Tabuleiro com martelos e chave inglesa (1/3 de gaveta)

Composição:

M09300 Martelo tipo alemão
M11035 Martelo borracha (anti recuo)
W27AS10 Chave inglesa

A



M63113KV

69.00€

Tabuleiro com saca troços, talhadeiras, punções e buril (1/3 de gaveta)

Composição:

6 Saca troços
4 Talhadeiras
1 Buril
1 Punção de bico
1 Punção

A



Tabuleiros de ferramenta para carros

Tabuleiros em espuma de alta densidade EVA

MHS08KV

69.00€

Tabuleiro com serra e vários (2/3 de gaveta)

Composição:

1 Serra com 2 lâminas extra
1 Fita métrica 3m
1 Régua 330mm
1 X-ato

B



P011804KV

85.00€

Tabuleiro com 4 alicates (1/3 de gaveta)

Composição:

P1118 1 Alicate universal
P0918 1 Alicate de corte diagonal
P0118 1 Alicate de pontas
P2710 1 Alicate ajustável

A



P32M105KV

74.00€

Tabuleiro com 5 alicates (1/3 de gaveta)

Composição:

AG010002 1 Alicate de freios interiores direito
AG010005 1 Alicate de freios interiores curvo
AG010008 1 Alicate de freios exteriores direito
AG010011 1 Alicate de freios exteriores curvo
P32M10A 1 Alicate de pressão

A



S03A4122KV

110.00€

Tabuleiro com 22 chaves de impacto 1/2" (1/3 de gaveta)

Composição:

S03A Jogo chaves impacto
10; 11; 12; 13; 14; 16; 17; 19; 21; 22 e 24
S03AD Jogo chaves impacto longa
10; 11; 12; 13; 14; 16; 17; 19; 21; 22 e 24

A



Tabuleiros de ferramenta para carros

Tabuleiros em espuma de alta densidade EVA

S04H2132KV

140.00€

Tabuleiro com 32 peças, chaves de bits e extensões (1/3 de gaveta)

Composição:

- S09H3 Chaves caixa bit hexagonais 3/8"
- S09H4 Chaves caixa bit hexagonais 1/2"
- S49H4 Chaves caixa bit estriado 1/2"
- S24H4 Extensões 1/2" - 125 e 250mm
- S17H4 Chaves velas - 16 e 21mm
- S23H4125 Cabo em "t" corrediço

A



S04H4144KV

135.00€

Tabuleiro com 44 peças, chaves caixa com roquete (1/3 de gaveta)

Composição:

- R3704 Roquete 1/2"
- R3702 Roquete 1/4"
- S04H4 Chaves caixa 1/2"
10; 11; 12; 13; 14; 15; 16; 17; 18; 19; 20; 21; 22; 23; 24;
27; 30 e 32mm
- S04H2 Chaves caixa 1/4"
4; 5; 5,5; 6; 7; 8; 9; 10; 11; 12 e 13mm
- S04HD2 Chaves caixa longa 1/4"
5; 6; 7; 8; 9; 10; 11; 12 e 13mm
- S24H2 Extensões 1/4" - 50 e 150mm
- S26H2150 Punho 1/4"
- S15H472 Cardan 1/4"

A

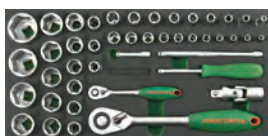

S06H427KV

113.00€

Tabuleiro com 27 bits de caixa (1/3 de gaveta)

Composição:

- S09H3 6x Bits hexagonais de 3/8"
- S09H4 11x Bits hexagonais de 1/2"
- S49H4 10x Bits estriados de 3/8"

A

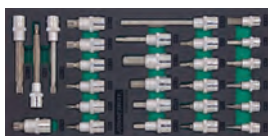

S07H2138KV

88.00€

Tabuleiro com 18 peças, jogo de bits (1/3 de gaveta)

Composição:

- S06H2 7 Chaves de caixa torx int. 1/4": E4; E5; E6; E7; E8; E10 e E11
- S07H2 11 Bits caixa Torx de 1/4": T6; T7; T8; T9; T10; T15; T20 e T25
- S09H2 5 Bits caixa hexagonais de 1/4": 3, 4, 5 e 6mm
- S10H2 4 Bits caixa fenda 1/4": 3; 4,5; 5,5 e 7mm
- S11H2 4 Bits caixa phillips 1/4": PH0, PH1; PH2 e PH3
- S12H2 4 Bits caixa pozi 1/4": PZ0, PZ1, PZ2 e PZ3
- AG010184C 1 Punho flexível 1/4" com caixa 7mm
- AG010184D 1 Punho flexível 1/4" com caixa 8mm
- 1 Punho flexível de 1/4" com caixa

A



S29H4141KV

91.00€

Tabuleiro com 41 peças, jogo de bits (1/3 de gaveta)

Composição:

- Bits hexagonais
- Bits torx
- Bits estriados
- Porta bits 1/2"
- Porta bits 3/8"
- Chave para molas de travão

A



W25106KV

38.00€

Tabuleiro com 6 chaves de bocas (1/3 de gaveta)

Composição:

- W25 6x7; 8x9; 10x11; 12x13; 14x15 e 16x17

A



W25107KV

92.00€

Tabuleiro com 7 chaves de bocas (2/3 de gaveta)

Composição:

- W25 18-19; 20-22; 21-23; 24-16; 25-28; 27-30 e 30-32mm

B



Tabuleiros de ferramenta para carros

Tabuleiros em espuma de alta densidade EVA

W25110KV 74.00€

Tabuleiro com 10 chaves de bocas (1/3 de gaveta)

Composição:

W25 6x7; 8x9; 10x11; 12x13; 14x15; 16x17; 18x19; 21x23; 24x27 e 30x32

A

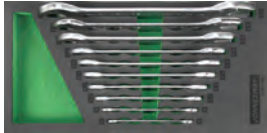

W26108KV 95.00€

Tabuleiro com 8 chaves mistas (2/3 de gaveta)

Composição:

W26 18; 19; 21; 22; 24; 27; 30 e 32mm

B



W26110KV 51.00€

Tabuleiro com 10 chaves mistas (1/3 de gaveta)

Composição:

W26 6; 7; 8; 10; 11; 12; 13; 14; 16 e 17mm

A



W26116KV 83.00€

Tabuleiro com 16 chaves mistas - boca/ luneta (1/3 de gaveta)

Composição:

W26 6; 7; 8; 9; 10; 11; 12; 13; 14; 15; 16; 17; 18; 19; 22 e 24mm

A

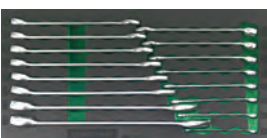

W65105KV 43.50€

Tabuleiro com 5 chaves curva luneta (1/3 de gaveta)

Composição:

8x10; 10x12; 13x15; 14x17 e 19x22mm

A

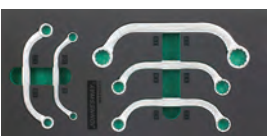

Tabuleiros de ferramenta para caixa C-6DA4

AG10002SC 65.00€

Jogo de machos e caçonetes

Composição:

Machos M3 a M12
Caçonetes M3 a M12
Porta caçonetes
Desandador de machos



D376514SC 44.00€

Jogo de chaves

Composição:

Jogo de chaves de precisão
Phillips: PH00; PH0 e PH1
Fenda: 2; 2,4 e 3mm
Torx: T5; T6; T7; T8; T9; T10; T15 e T20



P0813SC 49.00€

Jogo de alicates

Composição:

P087 Alicate universal
P097 Alicate de corte
P118 Alicate de pontas



R4811SC 73.00€

Jogo de chaves de caixa de 1/4" e 3/8"

Composição/ medidas em mm:

Roquete de 1/4" de 72 dentes
Roquete de 3/8" de 72 dentes
Extensão de 3/8": 75
Extensão de 3/8": 250
Extensão de 1/4": 50
Extensão de 1/4": 150
Cardan de 1/4"
Cardan de 3/8"
Adaptador 1/4" - 3/8"
Adaptador 3/8" - 1/2"
Punho



Tabuleiros de ferramenta para caixa C-6DA4
S04H5129SC
58.00€
Jogo de chaves de caixa sextavadas de 1/4 e 3/8" com 28 peças

Composição/ medidas em mm:

Chaves de caixa de 1/4": 4; 4,4; 5; 5,5; 6; 7; 8; 9; 10; 11; 12 e 13

Chaves de caixa longa: 8; 10; 12 e 13

Chaves de caixa 3/8": 14; 15; 17; 18; 19; 20; 22 e 24

Chaves de caixa longa: 14; 15 e 17

Chaves de velas 3/8": 16 e 21

V11011SC
48.50€
Jogo com alicate de cravar fêmeas

Composição/ medidas em mm:

Alicate de cravar

Bicos M3 a M6

W25117SC
65.00€
Jogo de chaves bocas e hexagonais

Composição/ medidas em mm:

Chaves de bocas: 8x9; 10x11; 12x13; 14x15; 16x17; 18x19; 20x22 e 24x27

Chaves hexagonais: 1,2; 2; 2,5; 3; 4; 5; 6; 8 e 10

W27AT02SC
58.00€
Jogo de alicates

Composição/ medidas em mm:

P32M10C Alicate de pressão

W27AT10 Chave ajustável

Tabuleiros em espuma EVA aplicáveis aos carros: C-4DW, C-6DW e C-7D

P-EVA(D70105KV)

11.20€

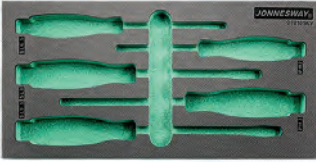

P-EVA(D71PP08KV)

11.70€



P-EVA(D737128SV)

33.50€



P-EVA(D737134SV)

33.50€

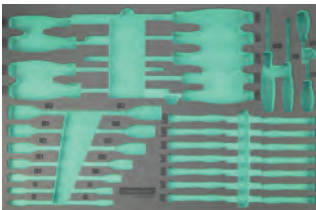

P-EVA(H10MB08KV)

11.30€



P-EVA(H10MT08KV)

11.30€



P-EVA(H10121SV)

33.50€

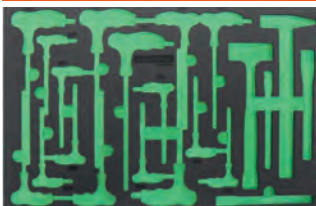

P-EVA(P82736SV)

34.00€



P-EVA(M09103KV)

11.30€



P-EVA(M63113KV)

11.30€



P-EVA(MHS08KV)

21.30€



P-EVA(P011804KV)

11.30€



P-EVA(P32M105KV)

11.30€



P-EVA(P82714SV)

34.00€



Tabuleiros de ferramenta vazios

Tabuleiros em espuma EVA aplicáveis aos carros: C-4DW, C-6DW e C-7D

P-EVA(S03A4122KV)

11.30€

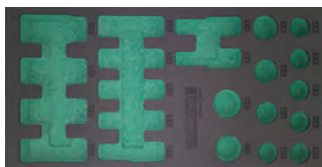

P-EVA(S04H2132KV)

11.30€



P-EVA(S04H4144KV)

11.30€



P-EVA(S04H4295SV)

33.00€

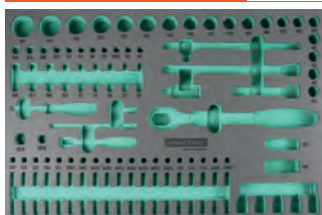

P-EVA(S04H42165SV)

33.00€



P-EVA(S04H45121SV)

33.00€

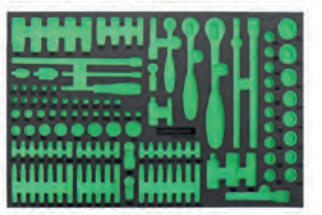

P-EVA(S29H4141KV)

11.30€

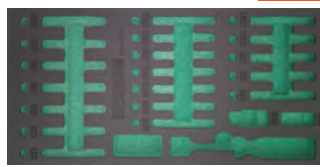

P-EVA(W23559SV)

33.50€



P-EVA(W25110KV)

11.30€

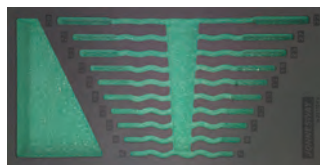

P-EVA(W26116KV)

11.30€

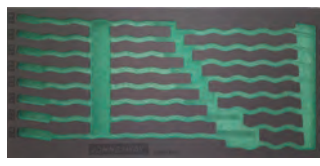

P-EVA(W26134SV)

35.00€



P-EVA(W2623431SV)

33.00€



Tabuleiros de ferramenta

Caixas plásticas para tabuleiros

P-B (31)

7.00€

Medidas:

425x185x52mm

B



P-B (41)

5.10€

Medidas:

375x144,5x52mm

A



Tabuleiros de ferramenta vazios para composições

aplicáveis aos carros: C-4DW, C-6DW e C-7DW

P-TR(AG010002SP)	2.70€
P-TR(AG010026SP)	2.70€
P-TR(AI10002SP)	2.90€
P-TR(D70105SP)	2.40€
P-TR(D71PP08SP)	2.40€
P-TR(H10MB08SP)	2.80€
P-TR(M09513SP)	2.70€
P-TR(M645114SP)	2.70€
P-TR(P018SP)	2.70€
P-TR(P04704SP)	2.70€
P-TR(P0803SP)	2.70€
P-TR(P0903SP)	2.70€
P-TR(P2710SP)	2.70€
P-TR(S03A4122SP)	2.70€
P-TR(S04H2125SP)	2.40€
P-TR(S04H3157SP)	3.30€
P-TR(S04H3536SP)	3.40€
P-TR(S04H4125SP)	3.20€
P-TR(S04H4524SP)	2.40€
P-TR(S04H4726SP)	3.30€
P-TR(S04H4728SP)	3.20€
P-TR(S06H427SP)	2.40€
P-TR(S09H4118SP)	2.70€
P-TR(S29H4140SP)	3.20€
P-TR(W23108SP)	2.70€
P-TR(W25110SP)	2.40€
P-TR(W26112SP)	2.70€
P-TR(W26116SP)	2.70€



Tabuleiros de ferramenta vazios para composições

aplicáveis à mala: C-3DH2

P-TR (D70SP06ST)

1.70€

Para chaves D70



P-TR (PC303ST)

1.70€

Para alicates: P087; P106 e P118



P-TR (S04H4120ST)

1.90€

Para chaves de caixa de 1/2" com roquete



P-TR (S04H4506ST)

1.90€

Para extensões



P-TR (W26107ST)

1.90€

Para chaves mistas W26



P-TR (W26920ST)

1.70€

Para chaves mistas W26 e chaves hexagonais



Ferramenta de aperto

T21

Chave dinamométrica com precisão de: +/- 3%

Ref.	Quadra	Torque (Nm)	Comp. (mm)	Preço
T21025N	1/4"	5-25	320	110.00€
T21050N	3/8"	10-50	390	122.00€
T211000N	1"	200-1 000	1 510	575.00€
T21101N	1/2"	20-100	390	145.00€
T21200N	1/2"	40-200	502	130.00€
T21340N	1/2"	60-340	604	155.00€
T21341N	3/4"	60-340	604	165.00€
T21550N	3/4"	110-550	938	375.00€



T25

Chave dinamométrica com precisão de: +/- 4%

Ref.	Quadra	Torque (Nm)	Comp. (mm)	Preço
T25100N	3/8"	20-100	390	99.00€
T25200N	1/2"	40-200	502	105.00€
T25340N	1/2"	60-340	604	125.00€



T27

Chave dinamométrica com precisão de: +/- 4%

Ref.	Quadra	Torque (Nm)	Comp. (mm)	Preço
T27010N	1/4"	2-10	308	73.00€
T27020N	1/4"	4-20	340	73.00€
T27021N	3/8"	4-20	340	73.00€
T27060N	3/8"	10-60	340	78.00€
T271001N	1"	200-1 000	1 177	535.00€
T27101N	1/2"	20-100	458	84.00€
T27200N	1/2"	40-200	531	93.00€
T27340N	1/2"	60-340	585	102.00€
T27800N	3/4"	150-800	1 177	445.00€



T30200NS

260.00€

Barra dinamométrica com conjunto de 9 ponteiros de bocas - Precisão 4%

Composição:

Torque: 40-200 Nm

Cabeçote 1/2"

Encaixe: 14x18mm

Ponteiras: 13; 14; 15; 17; 19; 22; 24; 27 e 30mm



T33

Chave dinamométrica reversível

Precisão: sentido horário: 5%
sentido anti-horário: 6%

Ref.	Quadra	Torque (Nm)	Preço
T33025N	1/4"	5-25	110.00€
T33050N	3/8"	10-50	115.00€
T33101N	1/2"	20-100	119.00€
T33200N	1/2"	40-200	119.00€
T33341N	3/4"	60-340	157.00€



T10H1210S

330.00€

Jogo de chave dinamométrica com 7 chaves intermutáveis 14x18

Torque: 40-210 Nm



T103

Chave "Pata de Galo" 14x18

Ref.	Medida (mm)	Preço
T31313	13	16.50€
T10314	14	12.60€
T10315	15	12.60€
T10316	16	12.60€
T10317	17	12.60€
T10318	18	12.60€
T10319	19	12.60€
T10321	21	12.60€
T10322	22	12.60€
T31324	24	19.00€



T290

Cabeçote para chave dinamométrica de cabeças intermutáveis

Ref.	Quadra	Medida (mm)	Preço
T29002	1/4"	14/18	21.00€
T29014	1/2"	14/18	26.00€
T29016	3/4"	14/18	36.00€



T14200N
250.00€
Chave dinamométrica digital intermutável com precisão de: +/- 1%

Capacidade: 20-200Nm

Memória: 10 leituras

Comprimento: 550mm

Unidade: Nm; fb-lb; Kg-m; in-lb

Peso: 1 150g

Pilhas: 3x1,5v AA (não incluídas)

Cabeçote: 14x18

T24135
350.00€
Chave dinamométrica digital reversível com aperto à esquerda e à direita
Precisão de: +/- 2% à direita | +/- 3% à esquerda

Torque: 6,8-135Nm

Quadra: 3/8"

T24200
340.00€
Chave dinamométrica digital com aperto à esquerda e à direita
Precisão de: +/- 2% à direita | +/- 3% à esquerda

Capacidade: 10-200Nm

Memória: 50 leituras

Comprimento: 530mm

Unidade: Nm; fb-lb; Kg-cm; in-lb

Quadra: 1/2"

T19
Medidor digital de torque com precisão de: +/- 2%

Com aviso luminoso e sonoro

Ref.	Quadra	Torque (Nm)	Preço
T19135N	3/8"	10-135	68.00€
T19200N	1/2"	20-200	70.00€

T19600N
275.00€
Medidor digital de torque

Quadra: 3/4"

Torque: 60-600 Nm

T
Kits de reparação para chaves dinamométricas

Ref.	Aplicáveis aos modelos	Preço
T04M060-R	T04M060	7.80€
T04M061-R	T04M061	7.80€
T04M150-R	T04M150	10.10€
T04M250-R	T04M250	13.60€
T07030N-R	T07030N	7.00€
T07110N-R	T07110N	7.90€
T07700N-R	T07700N	52.00€
T102001S-R	T102001S	13.00€
T154100N-R	T154100N	10.10€
T154200N-R	T154200N	14.50€
T16005N-R	T16005N	8.50€
T21025N-R	T21025N	10.00€
T21050N-R	T21050N	11.50€
T211000N-R	T211000N	64.00€
T21101N-R	T21101N	14.50€
T21200N-R	T21200N	13.00€
T21340N-R	T21340N	13.00€
T21341N-R	T21341N	45.00€
T21550N-R	T21550N	45.00€
T24135-R	T24135	21.00€
T24200-R	T24200	24.00€
T25100N-R	T25100N	11.50€
T25200N-R	T25200N	12.50€
T25340N-R	T25340N	12.50€
T27-D2R	T27010N, T27020N, T27030N	7.70€
T27-D3R	T27021N, T27031N, T27060N, T27100N	8.20€
T27-D4R1	T27101N	9.70€
T27-D4R2	T27200N, T27340N	11.20€
T27-D6R	T27500N, T27600N, T27800N, T271000N	27.50€
T27-D8R	T27801N, T271001N	46.50€
T33025N-R	T33025N	11.00€
T33050N-R	T33050N	13.00€
T33101N-R	T33101N	14.00€
T33200N-R	T33200N	14.00€
T33341N-R	T33341N	15.50€

R12
Roquete reversível de 60 dentes

Ref.	Quadra	Comp. (mm)	Preço
R1206N	3/4"	500	64.00€
R12081	1"	675	139.00€

R29

Roquete reversível de 36 dentes



Ref.	Quadra	Comp. (mm)	Preço
R2902	1/4"	146	13.50€
R2904	1/2"	278	20.50€

R34

Roquete de 72 dentes com punho antideslizante



Ref.	Quadra	Comp. (mm)	Torque (Nm)	Preço
R3403	3/8"	196	245	21.50€

R35

Roquete de 72 dentes com punho antideslizante



Ref.	Quadra	Comp. (mm)	Torque (Nm)	Preço
R3502	1/4"	135	68	17.00€
R3503	3/8"	199	245	21.00€
R3504	1/2"	250	647	25.00€

R36

Roquete metálico reversível de 48 dentes



Ref.	Quadra	Comp. (mm)	Torque (Nm)	Preço
R3602	1/4"	128	68	15.80€
R3603	3/8"	198	245	17.70€

R37

Roquete reversível de 48 dentes com punho antideslizante

Ref.	Quadra	Comp. (mm)	Torque (Nm)	Preço
R3702	1/4"	135	68	16.70€
R3703	3/8"	198	245	21.00€
R3704	1/2"	353	647	24.80€



R37B

Roquete reversível curto de 48 dentes com punho antideslizante



Ref.	Quadra	Comp. (mm)	Torque (Nm)	Preço
R3702B	1/4"	110	68	16.10€
R3704B	1/2"	180	647	22.50€

R41

Roquete reversível e articulado de 36 dentes com punho antideslizante



Ref.	Quadra	Comp. (mm)	Preço
R4103	3/8"	238	20.50€
R4104	1/2"	288	25.50€

R45

Roquete reversível e rotativo de 48 dentes



Ref.	Quadra	Comp. (mm)	Preço
R4502	1/4"	185	35.00€

R48

Roquete reversível de 72 dentes



Ref.	Quadra	Comp. (mm)	Preço
R4802	1/4"	146	14.50€
R4803	3/8"	185	16.50€
R4804	1/2"	278	21.40€

R48

Roquete metálico reversível de 72 dentes



Ref.	Quadra	Comp. (mm)	Preço
R4802A	1/4"	125	12.00€
R4804A	1/2"	250	20.00€

R48

Roquete curto reversível de 72 dentes

Ref.	Quadra	Comp. (mm)	Peso (g)	Preço
R4802B	1/4"	110	100	13.00€
R4804B	1/2"	170	442	19.50€

R51

Roquete reversível e extensível de 72 dentes com punho antideslizante

Ref.	Quadra	Comp. (mm)	Peso (g)	Preço
R5103	3/8"	220-230	440	21.00€
R5104	1/2"	300-400	930	26.70€

R66

Roquete com cabo rotativo de 60 dentes

Ref.	Quadra	Comp. (mm)	Peso (g)	Preço
R6602	1/4"	180	181	39.50€
R6603	3/8"	290	645	44.00€
R6604	1/2"	240	384	52.00€

R68

Roquete reversível de baixo perfil de 60 dentes

Ref.	Quadra	Peso (g)	Preço
R6802	1/4"	165	17.00€
R6803	3/8"	265	21.50€
R6804	1/2"	520	25.00€

RD01

Mini roquete

Quadra: 1/4"
Dentes: 60
Comprimento: 200mm



15.30€

RD02

Mini roquete flexível

Quadra: 1/4"
Dentes: 60
Comprimento: 170mm



18.00€

T094602

Roquete desmultiplicador 1/2" - 3/4" R 1:9

Torque máximo: 1 500 Nm



330.00€

T094602-RK

Kit de reparação

260.00€

Ferramenta de aperto
T096801

345.00€

Roquete desmultiplicador 3/4" - 1" R 1:4

Torque máximo: 2 500 Nm

T096801-RK

280.00€

Kit de reparação

T351060

145.00€

Aparafusador de torque de 1 a 6Nm

Composição:

Aparafusador: 1-6 Nm
Adaptador 1/4"
4 Bits phillips: PH0; PH1; PH2 e PH3
4 Bits fenda: 3; 4; 5 e 6mm
5 Bits torx: 10; 15; 20; 25 e 30
6 Bits hexagonais: 1.5; 2; 3; 4; 5 e 6mm

R

Kits de reparação para roquetes

Ref.	Aplicáveis aos modelos	Preço
R1206N-R	R1206N	25.00€
R1206R	R1206	23.00€
R2902RK	R2902; R2902A; R2902B	6.00€
R2903RK	R2903; R2903A; R2903B ; R4103	6.50€
R2904RK	R2904; R2904A; R2904B ; R4104	7.30€
R3602RK	R3602; R3702; R3702B; R3802	8.80€
R3603RK	R3603; R3703; R3803	11.30€
R3604RK	R3604; R3704; R3704B; R3804	12.50€
R3402RK	R3402; R3502	8.50€
R3403RK	R3403; R3503	10.50€
R3404RK	R3404; R3504	11.80€
R4502RK	Para cabeça de roquete	7.70€
R4502JRK	Para articulação	7.70€
R4802RK	R4802	5.90€
R4804RK	R4804	7.20€
R5103RK	R5103	6.50€
R5104RK	R5104	9.00€
R5802ERK	R5802E	10.60€
R5803RK	R5803	13.00€
R5804ERK	R5804E	16.50€
R5804LRK	R5804L	16.70€
R6802RK	R68	10.00€
R6803RK	R68	12.70€
R6804RK	R68	13.00€
R12081RK	R12081	65.00€



W24A107S 100.00€

Jogo de chaves luneta aberta flexível

Composição:

Chaves: 8x8; 10x10; 11x11; 12x12; 13x13; 14x14 e 17x17

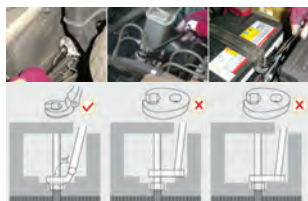

W45

Chave combinada boca/ roquete



Ref.	Medida (mm)	Comp. (mm)	Preço
W45108	8	135,40	8.80€
W45109	9	159,50	9.30€
W45110	10	159,50	9.30€
W45111	11	165,90	9.30€
W45112	12	168,60	9.50€
W45113	13	178,50	10.00€
W45114	14	190,50	10.50€
W45115	15	199,40	12.00€
W45116	16	206,40	12.30€
W45117	17	225,40	13.20€
W45118	18	236,40	14.50€
W45119	19	247,40	14.50€
W45121	21	281,00	22.00€
W45122	22	281,00	24.00€
W45124	24	281,00	25.00€
W45127	27	330,00	38.30€
W45130	30	425,00	49.50€
W45132	32	425,00	50.50€

W45110S 94.00€

Jogo de chaves de boca/ roquete de 9 peças

Composição:

W45 Chaves: 8; 10; 12; 13; 17 e 19mm
Adaptadores 1/4"; 3/8" e 1/2"
Porta bits



W45117S 340.00€

Jogo de chaves combinadas boca/ roquete com 72 dentes de 17 peças

Composição:

W45 Chaves: 8; 10; 12; 13; 14; 17; 19; 21; 22; 24; 27; 30 e 32mm
Adaptadores 1/4"; 3/8"; 1/2" e 3/4"
Porta bits
Mala



W45316S 160.00€

Jogo de chaves combinadas boca/ roquete com 72 dentes de 16 peças

Composição:

W45 Chaves: 8 a 19mm
Adaptadores 1/4"; 3/8" e 1/2"
Porta bits
Mala



W45316S-AD 16.00€

Conjunto de 4 adaptadores

Composição:

Adaptadores 1/4"; 3/8" e 1/2"
Porta bits



W45316S-AD12 5.50€

Adaptador 1/2" para chave 19mm



W45316S-AD14 3.90€

Adaptador 1/4" para chave 10mm



W45316S-AD34 15.00€

Adaptador 3/4" para chave 32mm



W45316S-AD38 4.50€

Adaptador 3/8" para chave 13mm



W45316S-ADBH14 1.75€

Porta bits 1/4" para chave 10mm



W51110S
118.00€
Jogo de 10 chaves curtas boca/ roquete

Composição:

W51 Chaves: 8; 10; 11; 12; 13; 14; 15; 16; 17 e 19mm

W52105S
90.00€
Jogo de 5 chaves curtas boca/ roquete flexível

Composição:

W52 Chaves: 8; 10; 12; 14 e 17mm

W66
Chave de boca/ roquete flexível

Ref.	Medida (mm)	Comp. (mm)	Preço
W66108	8	137	15.00€
W66109	9	159	15.00€
W66110	10	159	15.70€
W66111	11	175	16.00€
W66112	12	175	16.00€
W66113	13	186	17.50€
W66114	14	194	18.80€
W66115	15	216	18.80€
W66116	16	216	20.20€
W66117	17	232	20.70€
W66118	18	250	21.50€
W66119	19	250	22.00€
W66121	21	250	31.50€
W66124	24		38.30€

W66107S
118.00€
Jogo de 7 chaves de boca/ roquete flexível

Composição:

W66 Chaves: 8; 10; 11; 13; 14; 17 e 19mm

W66116S
230.00€
Jogo de chaves combinadas boca/ roquete flexível de 72 dentes com 16 peças

Composição:

W66 Chaves: 8 a 19mm
 Adaptadores 1/4"; 3/8" e 1/2"
 Suporte de bit
 Mala

W67104S
63.00€
Jogo de chaves luneta (torx) com roquete

Composição:

 Chaves: E6xE8; E10xE12;
 E14xE18 e E20xE24mm

W68
Chave roquete de 72 dentes

Ref.	Medida (mm)	Preço
W680809	8x9	14.50€
W680810	8x10	15.00€
W681011	10x11	15.80€
W681213	12x13	15.80€
W681415	14x15	18.50€
W681618	16x18	19.00€
W681719	17x19	21.00€

W68106S
95.00€
Jogo de chaves roquete de 72 dentes com 6 peças

Composição:

W68 Chaves: 8x9; 10x11; 12x13;
 14x15; 16x18 e 17x19

W73
Chave 4 em 1 com roquete

Ref.	Medida (mm)	Preço
W7310813	8x10 12x13	22.00€
W7311419	14x17 18x19	27.80€



W73102S

47.20€

Jogo de chaves com roquete 4 em 1

Podendo ser utilizadas em 4 medidas

Composição/ medidas em mm:

Chave 8x10 - 12x13

Chave 14x17 - 18x19



W91107S

94.00€

Jogo de chaves combinadas boca especial/ roquete de 72 dentes

Composição:

Chaves: 10; 12; 13; 14; 15; 17 e 19mm



W91

Chave boca especial/ luneta com roquete



Ref.	Medida (mm)	Comp. (mm)	Preço
W91110	10	159,5	10.00€
W91112	12	168,6	11.00€
W91113	13	178,5	11.50€
W91114	14	190,5	11.80€
W91115	15	199,4	13.00€
W91117	17	225,4	15.00€
W91119	19	247,4	15.50€

W93108S

130.00€

Jogo de chaves mistas com roquete reversível e anel de retenção

Composição:

Chaves: 10; 11; 12; 13; 14; 15;

17 e 19mm



W93

Chave mista boca roquete com anel retenção



Ref.	Medida (mm)	Comp. (mm)	Preço
W93110	10	158	13.20€
W93111	11	164	13.80€
W93112	12	167	14.80€
W93113	13	177	15.00€
W93114	14	189,4	16.20€
W93115	15	198	17.30€
W93117	17	224	20.00€
W93119	19	245	22.50€

W61

Chave luneta longa



Ref.	Medida (mm)	Comp. (mm)	Preço
W611011	10x11	295	10.50€
W611214	12x14	330	12.00€
W611315	13x15	370	15.00€
W611618	16x18	405	16.60€
W611719	17x19	405	16.60€
W612224	22x24	435	24.50€

W61106S

105.00€

Jogo de 6 chaves luneta longas

Fornecido em bolsa plástica com divisórias

Composição:

Medida	Comp. (mm)
10x11	235
12x14	330
13x15	370
16x18	405
17x19	405
22x24	435



W62

Chave luneta direita



Ref.	Medida (mm)	Comp. (mm)	Preço
W6210607	6x7	120	4.00€
W6210809	8x9	135	4.40€
W6211011	10x11	150	4.50€
W6211213	12x13	165	5.50€
W6211415	14x15	210	5.70€
W6211617	16x17	210	6.60€
W6211819	18x19	225	7.10€
W6212022	20x22	240	8.00€
W6212427	24x27	270	13.70€
W6212528	25x28	285	14.40€
W6213032	30x32	335	16.50€

W62108S

58.00€

Jogo de 8 chaves luneta direita

Composição:

W62 Chaves: 6x7; 8x9; 10x11; 12x13;
14x15; 16x17; 18x19 e 20x22mm

W23
Chave luneta 75°

Ref.	Medida (mm)	Comp. (mm)	Preço
W230607	6x7	168	4.00€
W230809	8x9	183	4.30€
W230810	8x10	183	4.90€
W231011	10x11	198	5.00€
W231113	11x13	217	5.60€
W231213	12x13	217	5.80€
W231317	13x17	217	7.00€
W231415	14x15	239	7.10€
W231617	16x17	260	7.40€
W231719	17x19	292	7.90€
W231819	18x19	292	8.40€
W231922	19x22	318	9.50€
W232022	20x22	318	10.20€
W232123	21x23	327	11.50€
W232224	22x24	327	11.80€
W232426	24x26	329	12.50€
W232427	24x27	329	12.80€
W232528	25x28	347	12.90€
W233032	30x32	362	16.30€

W23108S

58.00€

Jogo de 8 chaves luneta 75°

Fornecido em bolsa plástica com divisórias

Composição:

W23 Chaves: 6x7; 8x9; 10x11; 12x13;
14x15; 16x17; 18x19 e 20x22mm

W24
Chave luneta aberta

Ref.	Medida (mm)	Faces	Comp. (mm)	Preço
W240809	8x9	6	145	3.40€
W241011	10x11	6	152	3.50€
W241012	10x12	6	152	3.70€
W241213	12x13	6	165	4.00€
W241214	12x14	6	178	4.00€
W241314	13x14	6	178	4.10€
W241417	14x17	6	196	5.30€
W241617	16x17	12	196	5.60€
W241719	17x19	12	210	6.30€
W241819	18x19	12	210	6.90€
W241922	19x22	12	233	8.30€
W242224	22x24	12	252	10.70€
W242427	24x27	12	265	13.20€
W242528	25x28	12	265	13.20€
W243032	30x32	12	285	14.70€

W24106S

37.00€

Jogo de 6 chaves luneta aberta

Fornecido em bolsa plástica com divisórias

Composição:

W24 Chaves: 8x9; 10x11; 10x12;
13x14; 16x17 e 17x19mm

W24N
Chave luneta aberta com batente

Ref.	Medida (mm)	Comp. (mm)	Preço
W24N0810	8x10	122	7.70€
W24N1113	11x13	143	9.00€
W24N1214	12x14	145	9.20€
W24N1719	17x19	162	13.00€



Ferramenta de aperto

W25

Chave de bocas



Ref.	Medida (mm)	Comp. (mm)	Preço
W250607	6x7	123	2.40€
W250608	6x8	123	2.40€
W250809	8x9	140	2.60€
W251011	10x11	156	2.80€
W251012	10x12	156	2.80€
W251213	12x13	172	3.30€
W251214	12x14	180	3.30€
W251415	14x15	190	3.70€
W251417	14x17	195	4.10€
W251617	16x17	205	4.30€
W251618	16x18	205	4.40€
W251719	17x19	221	5.00€
W251819	18x19	221	5.00€
W251922	19x22	237	6.30€
W252022	20x22	237	6.30€
W252123	21x23	247	6.70€
W252224	22x24	247	7.00€
W252426	24x26	263	8.50€
W252427	24x27	263	8.60€
W252528	25x28	279	10.50€
W252730	27x30	283	11.40€
W252732	27x32	289	11.50€
W253032	30x32	298	11.50€
W253236	32x36	330	22.00€
W253641	36x41	380	28.00€
W253842	38x42	380	28.40€
W254146	41x46	415	40.00€
W254650	46x50	430	58.00€

W25108S

40.00€

Jogo de 8 chaves de bocas

Fornecido em bolsa plástica com divisórias

Composição:

W25 Chaves: 6x7; 8x9; 10x11; 12x13; 14x15; 16x17; 18x19 e 20x22mm



W26

Chave de bocas/ luneta



Ref.	Medida (mm)	Preço
W26106	6	2.20€
W26107	7	2.30€
W26108	8	2.35€
W26109	9	2.45€
W26110	10	2.75€
W26111	11	2.75€
W26112	12	3.00€
W26113	13	3.30€
W26114	14	3.40€
W26115	15	3.90€
W26116	16	4.00€
W26117	17	4.70€
W26118	18	5.10€
W26119	19	5.60€
W26120	20	6.20€
W26121	21	6.70€
W26122	22	7.00€
W26123	23	7.70€
W26124	24	8.10€
W26125	25	8.80€
W26126	26	9.30€
W26127	27	10.00€
W26128	28	10.60€
W26129	29	11.50€
W26130	30	12.20€
W26132	32	13.30€
W26134	34	23.30€
W26136	36	29.00€
W26138	38	36.00€
W26141	41	43.00€
W26142	42	43.50€
W26144	44	52.50€
W26146	46	53.00€
W26148	48	69.00€
W26150	50	73.00€
W26155	55	112.00€
W26160	60	155.00€
W26165	65	205.00€

W26

Jogo de chaves de boca/ luneta

Fornecido em bolsa plástica com divisórias

Ref.	Chaves	Medida (mm)	Preço
W26112S	12xW26	8 a 17; 19 e 22	57.00€
W26114S	14xW26	10 a 14; 16; 17; 19; 21; 22; 24; 27; 30 e 32	92.00€
W26126S	26xW26	6 a 32	184.00€



W26411PRS

65.00€

Jogo de 11 chaves mistas longas

Fornecido em bolsa plástica com divisórias

Composição:

W264 Chaves: 7; 8; 9; 10; 11; 12; 13; 14; 15; 17 e 19mm

W26414S

152.00€

Jogo de 14 chaves mistas boca/ luneta SAE

Fornecido em bolsa plástica com divisórias

Composição:

W26 Chaves: 3/8"; 7/16"; 1/2"; 9/16"; 5/8"; 11/16"; 13/16"; 7/8"; 15/16"; 1"; 1-1/16"; 1-1/8"; 1-1/4"

W29
Chave luneta para parafusos torx

Ref.	Medida	Comp. (mm)	Preço
W290608	E6xE8	112	6.30€
W290711	E7xE11	125	7.50€
W291012	E10xE12	140	7.50€
W291418	E14xE18	180	7.50€
W291622	E16xE22	200	8.10€
W292024	E20xE24	224	8.10€

W39
Chave de bocas de perfil fino

Ref.	Medida (mm)	Comp. (mm)	Preço
W391011	10x11	175	5.20€
W391213	12x13	210	6.50€
W391415	14x15	210	6.50€
W391617	16x17	250	9.50€
W391819	18x19	250	9.80€

W39108SA

75.00€

Jogo de 8 chaves de bocas de perfil fino

Composição:

W39 Chaves: 6x7; 8x9; 10x11; 12x13; 14x15; 16x17; 18x19 e 20x22mm

Ferramenta de aperto
W69116S

137.00€

Jogo de 16 chaves mistas 75°

Composição:

W69 Chaves: 7; 8; 9; 10; 11; 12; 13; 14; 15; 16; 17; 18; 19; 21; 22 e 24mm

S57
Chaves de cachimbo

Ref.	Medida (mm)	Preço
S57H108	8	8.00€
S57H109	9	9.60€
S57H110	10	10.20€
S57H111	11	10.40€
S57H112	12	12.50€
S57H113	13	16.00€
S57H115	15	16.00€
S57H116	16	16.50€
S57H117	17	18.50€
S57H118	18	18.50€
S57H119	19	19.50€
S57H121	21	26.50€
S57H122	22	34.00€
S57H123	23	34.00€
S57H124	24	37.50€
S57H125	25	38.00€
S57H127	27	49.00€
S57H132	32	64.00€

S57H108S

118.00€

Jogo de 8 chaves de cachimbo

Fornecido em bolsa plástica com divisórias

Composição:

S57 Chaves: 8; 10; 11; 13; 16; 17; 18 e 19mm

W65
Chave curva luneta para motores de arranque

Ref.	Medida (mm)	Preço
W6510810	8x10	3.80€
W6511012	10x12	4.10€
W6511315	13x15	4.50€
W6511417	14x17	5.50€
W6511922	19x22	7.40€



W65A

Chave curva luneta



Ref.	Medida	Comp. (mm)	Preço
W65A1012	10x12	141	8.00€
W65A1214	12x14	166	9.20€
W65A1315	13x15	190	12.50€
W65A1618	16x18	220	13.90€
W65A1719	17x19	220	14.80€
W65A1922	19x22	256	18.00€
W65A2224	22x24	22.00€	

W65A105S

65.00€

Jogo de 5 chaves curvas luneta

Composição:

W65A Chaves: 10x12; 12x14; 13x15; 16x18 e 17x19mm



W43A

Chave de caixa flexível



Ref.	Medida (mm)	Comp. (mm)	Preço
W43A0607	6x7	180	5.60€
W43A0809	8x9	180	5.70€
W43A1011	10x11	202	5.90€
W43A1213	12x13	222	7.20€
W43A1415	14x15	245	7.90€
W43A1617	16x17	260	9.50€
W43A1819	18x19	280	12.00€

W43A106S

55.00€

Jogo de 6 chaves de caixa flexíveis

Composição:

W43A Chaves: 8x9; 10x11; 12x13; 14x15; 16x17 e 18x19mm
Mala



W77A

Chave luneta 70° para extensão

Utiliza extensão da série W77H



Ref.	Medida (mm)	Comp. (mm)	Preço
W77A124	24	180	20.20€
W77A127	27	190	23.30€
W77A130	30	200	27.00€
W77A132	32	235	31.70€
W77A136	36	245	37.70€
W77A138	38	245	39.00€
W77A141	41	265	46.00€
W77A146	46	280	54.50€
W77A150	50	290	56.50€
W77A155	55	300	83.00€
W77A160	60	345	109.00€
W77A165	65	355	132.00€

W77H

Extensão para chave W77A

Utilizável em conjunto com as chaves da série W77A



Ref.	Medida (mm)	Utilizar em (mm)	Preço
W77H01	480	24~30	25.00€
W77H02	610	32~41	39.00€
W77H03	760	46~55	68.00€
W77H04	860	60~65	86.00€

WFS46

32.70€

Chave para filtro diferencial

Inclui chave hexagonal de 5mm

Medida: 46mm

Estriado de 12 faces

Aplicação: VW: Bora, Golf IV, Sharan
Skoda: Octavia



W67

Chave de boca pancada



Ref.	Medida (mm)	Comp. (mm)	Preço
W67119	19	177	6.00€
W67121	21	177	6.00€
W67124	24	197	7.20€
W67130	30	243	11.50€
W67132	32	273	14.50€
W67136	36	299	23.00€
W67138	38	299	24.50€
W67141	41	339	31.00€
W67145	45	374	35.50€
W67146	46	374	36.50€
W67150	50	417	47.00€
W67155	55	496	68.50€
W67160	60	496	68.50€
W67165	65	496	69.00€
W67170	70	496	111.00€

W72
Chave de luneta pancada

Ref.	Medida (mm)	Comp. (mm)	Preço
W72117	17	160	9.10€
W72118	18	160	9.10€
W72119	19	160	9.20€
W72121	21	160	9.30€
W72122	22	163	9.30€
W72124	24	163	9.70€
W72127	27	180	11.00€
W72130	30	190	14.00€
W72132	32	190	15.00€
W72134	34	205	20.70€
W72136	36	205	21.30€
W72141	41	230	26.00€
W72146	46	240	33.50€
W72150	50	255	46.00€
W72155	55	360	62.00€
W72170	70	335	151.00€

W27AR
Chave inglesa

Ref.	Abertura (mm)	Comp. (mm)	Preço
W27AR8	26,9	200	28.50€
W27AR10	34	250	36.00€



ON: funciona como roquete

OFF: funciona como chave inglesa

W27AL
Chave inglesa

Maior capacidade de abertura, mais fina e mais leve

Ref.	Medida (mm)	Abertura (mm)	Peso (mm)	Comprimento (mm)	Preço
W27AL10	250	43	277	256	31.40€

W27AS
Chave inglesa

Ref.	Abertura (mm)	Comp. (mm)	Preço
W27AS8	20	150	15.50€
W27AS10	29	250	18.50€
W27AS15	43	380	49.00€
W27AS18	53	450	81.00€

W27AT
Chave ajustável com cabo antideslizante

Ref.	Medida (mm)	Comp. (mm)	Preço
W27AT8	24	200	22.00€
W27AT10	29	250	26.00€
W27AT12	34	300	31.00€
W27AT15	43	375	60.00€

W27AK8

33.50€

Chave inglesa duplo sistema (métrico/SAE)

Comprimento: 200mm



Ferramenta de aperto

Ferramenta SUPERTECH

W28HD

Chave bico de falcão para tubos

Ref.	Abertura (mm)	Comp. (mm)	Preço
W28HD8	10-22	200	34.00€



W28

Chave para tubos

Ref.	Abertura (mm)	Comp. (mm)	Preço
W2808	25,5	200	17.50€
W2810	38	250	19.50€
W2812	51	300	25.50€
W2814	51	350	31.50€
W2818	63,5	450	45.00€
W2824	76	600	74.00€
W2836	127	900	165.00€



W28RJ-HL

Garras de substituição

Ref.	Aplicável modelo	Preço
W2810RJ-HL	W2810	6.10€
W2812RJ-HL	W2812	7.30€
W2814RJ-HL	W2814	8.00€
W2818RJ-HL	W2818	10.80€
W2824RJ-HL	W2824	16.70€
W2836RJ-HL	W2836	35.00€

S68H2141S

59.00€

Jogo de 41 peças de 1/4" SUPERTECH

Composição/ medidas em mm:

R2902 Roquete de 36 dentes
Chaves caixa: 4; 4,5; 5; 5,5; 6; 7; 8; 9; 10; 11; 12; 13 e 14
Chaves hexagonais: 1,5; 2 e 2,5
20 Bits
Extensão de 50
Cabo "T" correção
Adaptador hexagonal
Punho



S68H4127S

132.00€

Jogo de 27 peças de 1/2" SUPERTECH

Composição/ medidas em mm:

R2904 Roquete de 36 dentes
Chaves caixa: 8 a 24; 27; 30 e 32
Chaves de velas: 16 e 21
Cardan
Extensão de 125 e 250
Cabo "T" correção



S68H

Chave de caixa 1/4" SUPERTECH

Ref.	Medida (mm)	SAE	Torque	Preço
S68H2103	3	1/8"	E4	0.85€
S68H2104	4	5/32"	E5	0.85€
S68H21045	4,5			0.85€
S68H2105	5	3/16"	E6	0.85€
S68H21055	5,5	7/32"	E7	0.85€
S68H2106	6		E8	0.90€
S68H21065	6,5	1/4"	E8	0.90€
S68H2107	7	9/32"		0.90€
S68H2108	8	5/16"	E10	0.95€
S68H2109	9	11/32"	E11	0.95€
S68H2110	10	3/8"	E12	0.95€
S68H2111	11	7/16"	E14	1.00€
S68H2112	12	15/32"		1.10€
S68H2113	13	1/2"	E16	1.10€
S68H2114	14	9/16"	E18	1.30€



Ferramenta SUPERTECH

S68H523411S

340.00€

Jogo de 111 peças de 1/4", 3/8" e 1/2" SUPERTECH

Composição/ medidas em mm:

- R3702 Roquete de 1/4"
- R3703 Roquete de 3/8"
- R3704 Roquete de 1/2"
- Chaves caixa de 1/4": 3,2 a 13
- Chaves caixa de 3/8": 9 a 19
- Chaves caixa de 1/2": 14 a 32
- Chaves de velas de 3/8": 14 e 18
- Chaves de velas de 1/2": 16 e 21
- Chaves hexagonais: 1,5; 2 e 2,5
- Chaves mistas boca/ luneta: 8 a 19
- Bits de 1/4" fenda/ phillips/ torx/ hexagonal/pozi
- Bits de 5/16" fenda/ phillips/ torx/ hexagonal/pozi
- Adaptador bits 5/16"
- Cardan de 1/4"; 3/8" e 1/2"
- Extensões de 1/4" com 50 e 150
- Extensões de 3/8" com 75 e 150
- Extensões de 1/2" com 125 e 250
- Adaptador "T" para extensões
- Punho



W84108S

60.00€

Jogo de 8 chaves mistas boca/ luneta SUPERTECH

Chaves: 8; 10; 11; 12; 13; 14; 17 e 19mm



Ferramenta de aperto

W84114S

94.00€

Jogo de 14 chaves mistas boca/ luneta SUPERTECH

Chaves: 6 a 19mm



W84

Chave mista boca/ luneta SUPERTECH

Ref.	Medida (mm)	Preço
W84106	6	4.10€
W84107	7	4.20€
W84108	8	4.30€
W84109	9	4.50€
W84110	10	4.80€
W84111	11	5.10€
W84112	12	5.50€
W84113	13	5.90€
W84114	14	6.30€
W84115	15	7.10€
W84116	16	7.60€
W84117	17	8.40€
W84118	18	9.00€
W84119	19	9.90€

W86112S

219.00€

Jogo de 12 chaves boca/ roquete SUPERTECH

Chaves: 8 a 19mm



S03H2327S

68.50€

Jogo de chaves e bits de caixa de 1/4" com 27 peças

Composição/ medidas em mm:

- Chave mista boca/roquete
- Mini chaves 13mm: 4; 4,5; 5; 5,5; 6; 7; 8; 9; 10; 11; 12; 13 e 14
- Bits caixa hexagonais: 3; 4; 5 e 6mm
- Bits caixa phillips: PH1; PH2 e PH3
- Bits caixa fenda: 5,5 e 7mm
- Cardan
- Extensão 50mm
- Cabo "T" corrediço 115mm

S04H2118S

39.00€

Jogo de chaves de caixa de 1/4" com 18 peças

Composição/ medidas em mm:

- R2902 Roquete de 36 dentes
- S04H2 Chaves caixa: 4; 4,5; 5; 5,5; 6; 7; 8; 9; 10; 11; 12 e 13
- S24H2 Extensões de 2" e 4"
- S23H2 Cabo "T" corrediço
- S15H240 Adaptador universal
- S22H2130 Punho flexível

S04H2141S

71.00€

Jogo de chaves de caixa de 1/4" com 41 peças

Composição/ medidas em mm:

- R3702 Roquete de 48 dentes
- S04H2 Chaves caixa: 4; 5; 5,5; 6; 7; 8; 10; 11; 12 e 13
- S04HD2 Chaves longas de caixa: 7; 8 e 10
- Chaves macho hexagonais: 1,5; 2; 2,5 e 3
- S09H2 Bits hexagonais: 3; 4; 5 e 6
- S07H2 Bits torx: T10; T20; T25; T27; T30 e T40
- S10H2 Bits fenda: 0,8x4; 10x5,5 e 1,2x7
- S11H2 Bits phillips: PH1; PH2 e PH3
- S24H Extensões de 2" e 6"
- S28H1 Punho
- S15H240 Adaptador universal
- S27H2150 Extensão flexível 6"
- S16H3814 Adaptador 3/8 (F) x 1/4" (M)
- Caixa metálica

S04H3125S

75.00€

Jogo de chaves de caixa de 3/8" com 25 peças

Composição/ medidas em mm:

- R3703 Roquete de 48 dentes
- Chaves caixa: 6 a 22
- Chaves de velas: 16 e 21
- S24H Extensões de 75 e 150
- S23H31200 Cabo "T" corrediço de 200
- S15H356 Cardan
- Caixa metálica

S04H3141S

116.00€

Jogo de chaves de caixa de 3/8" com 40 peças

Composição/ medidas em mm:

- R3703 Roquete de 48 dentes
- S04H3 Chaves caixa: 6 a 24
- Chaves de caixa longas: 14; 15; 17 e 19
- Bits torx: T10; T20; T25; T27; T30; T40; T45 e T50
- Bits fenda: 0,8x4; 1x5,5 e 1,2x8
- Bits phillips: PH1; PH2 e PH3
- 2 Extensões
- Cardan
- Adaptador universal
- Mala de transporte

S04H3157S

135.00€

Jogo de chaves de caixa de 1/4" e 3/8" com 56 peças

Composição/ medidas em mm:

- R3702 Roquete 1/4" de 48 dentes
- R3703 Roquete 3/8" de 48 dentes
- S04H2 Chaves de 1/4": 4; 4,5; 5; 5,5; 6; 7; 8; 9; 10; 11; 12 e 13
- S04HD2 Chaves longas de 1/4": 8; 10; 12; e 13
- S04H3 Chaves de 3/8": 14; 15; 17; 18; 19; 20; 22 e 24
- S04HD3 Chaves longas 3/8": 14; 15; 17
- S17H3 Chaves velas 3/8": 16 e 21
- S09H2 Bits hexagonais: 3; 4; 5 e 6
- S07H2 Bits torx: T10; T15; T20; T25; T27 e T30
- S10H2 Bits fenda: 4; 5,5 e 7
- S11H2 Bits phillips: PH1; PH2 e PH3
- S24H2 2 Extensões 1/4" (50mm + 150mm)
- S24H3 2 Extensões 3/8" (75mm + 250mm)
- S16H302 Adaptador de extensão 1/4" - 3/8"
- S16H403 Adaptador de extensão 1/2" - 3/8"
- S15H356 Adaptador universal 3/8"
- S15H240 Adaptador universal 1/4"
- S26H2150 Punho



S04H3536S

105.00€

Jogo de chaves de caixa de 3/8" com 36 peças

Composição/ medidas em mm:

- R3503** Roquete de 72 dentes
 Chaves caixa: 6 a 22mm
 Chaves mistas: 7 a 17mm
 Chaves de velas: 16 e 21mm
 Extensões de 75; 150 e 225mm
S16H403 Cardan
 Adaptador
 Caixa metálica



S04H6115S

215.00€

Jogo de chaves de caixa de 3/4" com 14 peças

Composição/ medidas em mm:

- Roquete
 Chaves caixa: 22; 24; 27; 30; 32; 36; 38; 41; 46 e 50
 Extensão de 100 e 200
 Cabo "T" correção



S04H4125S

112.00€

Jogo de chaves de caixa de 1/2" com 25 peças

Composição/ medidas em mm:

- R3704** Roquete de 48 dentes
S04H4 Chaves caixa: 10 a 24; 27; 30 e 32
 Chaves de velas: 16 e 21
 Extensões de 5" e 10"
 Cabo "T" correção
 Adaptador universal
 Mala de transporte



S04H6321S

335.00€

Jogo de chaves de caixa de 3/4" com 20 peças

Composição/ medidas em mm:

- R1206N** Roquete reversível de 500
S04H61 Chaves caixa: 19; 21; 22; 24; 27; 30; 32; 36; 38; 41; 46 e 50
S24H6 Extensão de 100; 200 e 400
S22H6475 Cabo articulado 475
S16H3412 Adaptador 3/4"F para 1/2"M
S16H3410 Adaptador 3/4"F para 1"M
S15H6109 Adaptador universal
 Mala de transporte



S04H4524S

111.00€

Jogo de chaves de caixa de 1/2" com 24 peças

Composição/ medidas em mm:

- R3704** Roquete de 48 dentes
S04H4 Chaves caixa: 10 a 24; 27; 30 e 32
S24H4 Extensões de 5" e 10"
S23H41300 Cabo "T" correção
S15H472 Adaptador universal
S22H41375 Punho flexível 15"
 Caixa metálica



S04H8115S

540.00€

Jogo de chaves de caixa de 1" com 14 peças

Composição/ medidas em mm:

- Roquete
 Chaves caixa: 36; 41; 46; 50; 55; 60; 65; 70; 75 e 80
 Extensão de 200 e 400
 Cabo de 550



S04H4728S

125.00€

Jogo de chaves de caixa sextavadas de 1/2" com 28 peças

Composição/ medidas em mm:

- R3704** Roquete de 48 dentes
S04H4 Chaves caixa: 8 a 28; 30; 32 e 34
S24H4250 Extensão 10"
S23H41300 Cabo "T" correção
S15H472 Adaptador universal
 Caixa metálica



S06H425S

53.00€

Jogo de 25 bits torx de 1/2" e 1/4"

Composição/ medidas em mm:

- S07H2** Bits torx de 1/4": T8; T10; T15; T20; T25; T27 e T30x32
S07H3 Bits torx de 1/2": T40; T45; T50; T55 e T60x55
S06H2 Chaves parafusos torx 1/4": E4; E5; E6; E7 e E8
S06H4 Chaves parafusos torx 1/2": E10; E11; E12; E14 e E18
H08 Chaves macho torx: T6; T8 e T10



S06H4127S

107.00€

Jogo de 27 bits de 1/2" e 3/8"

Composição/ medidas em mm:

S09H4 Bits hexagonais de 1/2": 4; 5; 6; 7; 8; 10 e 12x55; 14x60; 17x70; 8x80 e 10x140

S49H4 Bits estriados de 1/2": M5; M6; M8; M10; M12; M14; M16x55; M10; M12x110 e M8x120

S09H3 Bits hexagonais de 3/8": 4; 5; 6; 7; 8 e 10x48



S07H4109S

32.50€

Jogo de 9 chaves bits torx de 1/2"

Composição:

T20; T25; T27; T30; T40; T50; T55 e T60



S07H4932S

130.00€

Jogo de 32 chaves bits torx de 1/2"

Composição:

Bits 55mm: T20; T25; T27; T30; T40; T45; T50; T55; T60 e T70

Bits 100mm: T20; T25; T27; T30; T40; T45; T50; T55; T60 e T70

Bits 140mm: T40; T45; T50; T55; T60 e T70

Bits 200mm: T40; T45; T50; T55; T60 e T70

Mala de transporte



S09H4109S

33.00€

Jogo de 9 chaves bits hexagonais de 1/2"

Composição:

H3; H4; H5; H6; H7; H8; H10; H12 e H14



S63H4132S

125.00€

Jogo de 32 chaves bits de 6 caneluras (Ribe) 1/2"

Composição:

Bits 55mm: M5; M6; M7; M8; M9; M10; M12; M13 e M14

Bits 100mm: M5; M6; M7; M8; M9; M10; M12; M13 e M16

Bits 140mm: M8; M9; M10; M12; M13 e M14

Bits 200mm: M8; M9; M10; M12; M13 e M14

Mala de transporte



S64H4126S
115.00€
Jogo de 26 chaves bits ZNX 1/2"

Composição:

Bits 55mm: M5; M6; M8; M10; M12; M14 e M16
 Bits 100mm: M5; M6; M8; M10; M12 e M14
 Bits 140mm: M5; M6; M8; M10; M12 e M14
 Bits 200mm: M8; M10; M12 e M14
 Mala de transporte

S04H52477S
205.00€
Jogo de 77 peças de ferramenta de 1/2" e 1/4"

Composição/ medidas em mm:

R2904 Roquete 1/2" reversível de 36 dentes
 R2902 Roquete 1/4" reversível de 36 dentes
 S04H4 Chaves caixa 1/2": 12 a 32
 S04H21 Chaves caixa 1/4": 4 a 12
 S04HD21 Chaves de caixa longas 1/4": 8; 10; 12 e 13
 S17H Chaves de velas 1/2": 16 e 21mm
 W26 Chaves boca/ luneta: 8; 10; 12; 13; 14; 15; 17 e 19
 D04 Jogo de chaves fenda
 S24H Extensões 1/2" de 125 e 250
 S24H275 Extensão 1/4" com 75
 S15H472 Adaptador universal 1/2"
 S15H240 Adaptador universal 1/4"
 S16H304 Adaptador 3/8"F para 1/2"M
 S23H21130 Cabo "T" correção 1/4"
 P2810 Alicates ajustáveis
 P088 Alicates universais
 Pontas de 1/4"
 M09500 Martelo de mecânico tipo "Alemão" 500g
 Mala de transporte

S04H52460S
164.00€
Jogo de 60 peças de ferramenta de 1/2" e 1/4"

Composição/ medidas em mm:

Roquete 1/2" de 36 dentes
 Chaves caixa 1/2": 12; 13; 14; 15; 17; 18; 19; 22 e 24
 Chaves caixa 1/4": 6; 8; 9; 10; 11; 12 e 13
 Chaves de velas 1/2": 16 e 21
 Chaves mistas: 8; 10; 12; 13; 14 e 17
 Jogo de chaves fenda/ phillips
 Bits de 1/4": fenda, torx e phillips
 Porta bits de 1/4"
 Extensões 1/2" de 125 e 250
 Extensão 1/4" com 75
 Extensão flexível de 1/4"
 Adaptador 3/8"F para 1/2"M
 Cabo "T" correção 1/4"
 Alicates ajustáveis
 Alicates universais
 Pontas de 1/4"
 Martelo
 Cardan de 1/2"
 Punho de 1/4"

S04H52478S
268.00€
Jogo de 78 peças de ferramenta de 1/2" e 1/4"

Composição/ medidas em mm:

Roquete 1/2" de 48 dentes
 Roquete 1/4" de 48 dentes
 Chaves caixa 1/4": 5 a 11
 Chaves caixa longas 1/4": 5 a 12
 Chaves de velas 1/2": 16 e 21
 Chaves caixa 1/2": 12 a 19; 22; 24; 27 e 32
 Chaves mistas: 6 a 17; 19; 21; 22 e 24
 Chaves allen hexagonais: 2,5 a 10
 Chaves allen torx: T10; T15; T20; T25; T27; T30 e T40
 Chaves luneta aberta: 8x10; 11x13; 12x14 e 17x19
 Jogo de chaves fenda/ phillips
 Extensões 1/2" de 125 e 250
 Extensão 1/4" com 50
 Adaptador 3/8"F para 1/2"M
 Cabo "T" correção 1/4"
 Alicates de pressão
 Cardan de 1/2" e 1/4"
 Punho de 1/4"



S04H524127S

450.00€

Jogo de 127 peças de ferramenta de 1/2" e 1/4"

Composição/ medidas em mm:

- R2904 Roquete 1/2" reversível de 36 dentes
- R2902 Roquete 1/4" reversível de 36 dentes
- Chaves caixa 1/2": 8 a 11; 13 a 19; 21; 22; 24; 27; 30 e 32
- Chaves caixa 1/4": 4; 4,5; 5; 5,5; 6 a 13
- Chaves caixa longa 1/2": 10; 12; 13; 14; 15; 17 e 19
- Chaves caixa longa 1/4": 7; 8; 10; 12 e 13
- Chaves de velas 1/2": 16 e 21
- Chaves caixa torx 1/4": E4; E5; E6; E7 e E8
- Chaves torx 1/2": E10; E12; E14; E16; E18; E20; E22 e E24
- Chaves mistas: 6 a 17; 19; 21; 22; 24; 27; 30 e 32
- Chaves luneta aberta: 8x10; 9x11; 12x13; 14x17 e 17x19
- Chaves hexagonais curtas: 1,5; 2; 2,5; 3; 4; 5; 6; 8 e 10
- Chaves torx: T10; T15; T20; T25; T27; T30 e T40
- Chaves fendas com punho antideslizante
- Chaves phillips com punho antideslizante
- Jogo de punções e escopros
- S21H Extensões 1/4" de 50x150 e de 1/2" 50mm
- S24H Extensões 1/2" de 125 e 250 e de 1/4" de 75
- Extensão flexível 1/4" de 145
- Cabo "T" correção 1/4" de 130 e 1/2" de 250
- Cabo articulado 1/2" de 375
- P2810 Alicates ajustáveis
- P8606 Alicates de corte
- P8007 Alicates universais
- AG010034 Caneta magnética
- M09500 Martelo de mecânico tipo "Alemão" 500g
- Cardan de 1/2" e 1/4"
- Mala de transporte

S04H624101S

282.00€

Jogo de 101 peças de ferramenta de 1/2" e 1/4"

Composição/ medidas em mm:

- R2904 Roquete 1/2" reversível de 36 dentes
- R2902 Roquete 1/4" reversível de 36 dentes
- S04H4 Chaves caixa sextavadas 1/2": 8 a 24; 27; 30 e 32
- S04H2 Chaves caixa sextavadas 1/4": 4; 4,5; 5; 5,5; 6; 7; 8; 9 e 10
- S17H4 Chaves de velas 1/2": 16 e 21
- S06H4 Chaves caixa torx 1/2": E11; E12; E14; E16 e E18
- W24 Chaves luneta aberta: 8x10; 11x13; 12x14 e 17x19
- W26 Chaves boca/ luneta: 8; 10 a 19; 21; 22 e 24
- D04 Jogo de chaves fenda
- S24H4 Extensões 1/2" de 125 e 250
- S21H4 Extensão 1/2" de 50
- S24H2 Extensões 1/4" de 75 e 100
- S27H4 Extensão flexível 1/4"
- S14H4 Adaptador universal 1/2"
- S15H2 Adaptador universal 1/4"
- S23H2 Cabo "T" correção 1/4"
- S23H4 Cabo "T" correção 1/2"
- W27AS8 Alicates ajustáveis
- P087 Alicates universais
- AG010034 Caneta magnética
- Pontas de 1/4"
- Pontas XZN - M6; M8; M10 e M12
- Mala de transporte



S04H21

Chave de caixa sextavada 1/4"

Ref.	Medida (mm)	D1 (mm)	D2 (mm)	L (mm)	Preço
S04H2104	4	11,8	6,8	25	0.80€
S04H21045	4,5	11,8	7,3	25	0.80€
S04H2105	5	11,8	8	25	0.80€
S04H21055	5,5	11,8	8,6	25	0.85€
S04H2106	6	11,8	9,2	25	0.85€
S04H2107	7	11,8	10,5	25	0.85€
S04H2108	8	11,4	11,7	25	0.90€
S04H2109	9	11,6	12,7	25	0.95€
S04H2110	10	12,8	13,7	25	0.95€
S04H2111	11	14,4	15,7	25	1.00€
S04H2112	12	13,7	16,6	25	1.00€
S04H2113	13	13,9	17,6	25	1.10€
S04H2114	14	17,5	20	25	1.15€

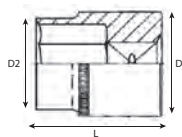
S04HD21

Chave de caixa sextavada longa 1/4"

Ref.	Medida (mm)	D1 (mm)	D2 (mm)	L (mm)	Preço
S04HD2105	5	11,8	8,1	50	1.40€
S04HD2106	6	12	9,2	50	1.40€
S04HD2107	7	12	10,5	50	1.40€
S04HD2108	8	11,5	12	50	1.40€
S04HD2109	9	11,3	13,2	50	1.50€
S04HD2110	10	13,3	14,4	50	1.50€
S04HD2111	11	14,8	15,9	50	1.60€
S04HD2112	12	15,8	17	50	1.70€
S04HD2113	13	16,8	17,8	50	1.80€

S04H31

Chave de caixa sextavada 3/8"

Ref.	Medida (mm)	D1 (mm)	D2 (mm)	L (mm)	Preço
S04H3106	6	16,8	9,6	28	1.10€
S04H3107	7	16,8	10,7	28	1.10€
S04H3108	8	16,8	12	28	1.10€
S04H3109	9	16,8	13,3	28	1.15€
S04H3110	10	16,8	14,4	28	1.15€
S04H3111	11	16,8	15,8	28	1.15€
S04H3112	12	16	16,8	28	1.20€
S04H3113	13	18	19	28	1.20€
S04H3114	14	18,8	19,7	28	1.20€
S04H3115	15	19,8	20,8	28	1.20€
S04H3116	16	20,8	22	28	1.25€
S04H3117	17	22	23,8	28	1.45€
S04H3118	18	24,1	25,7	28	1.55€
S04H3119	19	24,1	25,7	28	1.60€
S04H3120	20	25	27,6	32	1.75€
S04H3121	21	25	27,6	32	1.85€
S04H3122	22	27,8	29,6	32	2.00€
S04H3124	24	29,8	31	32	2.15€

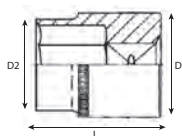

S04HD31

Chave de caixa sextavada longa 3/8"



Ref.	Medida (mm)	D1 (mm)	D2 (mm)	L (mm)	Preço
S04HD3109	9	16,8	13,3	63	2.10€
S04HD3110	10	17	14,4	63	2.10€
S04HD3111	11	17	15,8	63	2.20€
S04HD3112	12	17	17,7	63	2.30€
S04HD3113	13	18	19	63	2.30€
S04HD3114	14	18,8	19,7	63	2.30€
S04HD3115	15	19,8	20,8	63	2.40€
S04HD3116	16	20,8	22	63	2.40€
S04HD3117	17	22,8	23,8	63	2.70€
S04HD3119	19	23,8	26	63	2.90€
S04HD3120	20	24,8	27,8	63	3.20€
S04HD3121	21	25,8	28	63	3.20€
S04HD3124	24	28	24	63	3.60€

S04H41

Chave de caixa sextavada 1/2"

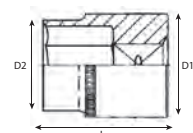

Ref.	Medida (mm)	D1 (mm)	D2 (mm)	L (mm)	Preço
S04H4108	8	21,8	13,8	38	1.45€
S04H4109	9	21,8	14,3	38	1.45€
S04H4110	10	21,8	15,4	38	1.50€
S04H4111	11	21,8	16,7	38	1.50€
S04H4112	12	21,8	18	38	1.50€
S04H4113	13	21,8	19	38	1.55€
S04H4114	14	22	20,3	38	1.55€
S04H4115	15	22	21,3	38	1.55€
S04H4116	16	22	23,3	38	1.65€
S04H4117	17	23	23,8	38	1.70€
S04H4118	18	23,5	24,8	38	1.85€
S04H4119	19	24	27	38	1.85€
S04H4120	20	24	28	38	2.15€
S04H4121	21	24	29	38	2.20€
S04H4122	22	28	30	38	2.50€
S04H4123	23	28	30,7	38	2.65€
S04H4124	24	28	31,8	38	2.75€
S04H4125	25	28	33,8	38	3.15€
S04H4126	26	30	34	42	3.35€
S04H4127	27	28	35,7	42	3.35€
S04H4128	28	30	38	42	3.40€
S04H4129	29	32	38	42	4.10€
S04H4130	30	34	39,8	42	4.10€
S04H4132	32	36	42	42	4.20€
S04H4134	34	40	45	48	5.80€
S04H4136	36	41	48	48	7.30€



S04HD41

Chave de caixa sextavada longa 1/2"



Ref.	Medida (mm)	D1 (mm)	D2 (mm)	L (mm)	Preço
S04HD4109	12	21,8	12,7	76	3.30€
S04HD4110	10	21,8	15,4	76	3.40€
S04HD4111	11	21,8	16,7	76	3.40€
S04HD4112	12	21,8	18	76	3.50€
S04HD4113	13	21,8	19	76	3.50€
S04HD4114	14	22	20,3	76	3.60€
S04HD4115	15	22	21,3	76	3.70€
S04HD4116	16	22	23	76	3.70€
S04HD4117	17	23	23,8	76	3.80€
S04HD4118	18	23	24,8	76	3.90€
S04HD4119	19	24	25,8	76	4.00€
S04HD4120	20	24	28	76	4.10€
S04HD4121	21	24	29	76	4.10€
S04HD4122	22	26	30	76	4.20€
S04HD4123	23	28	31,8	76	4.30€
S04HD4124	24	28	31,8	76	4.30€
S04HD4125	25	28	33,8	76	6.00€
S04HD4126	26	28	33,8	76	6.20€
S04HD4127	27	28	35,7	76	6.40€
S04HD4128	28	30	38	76	7.10€
S04HD4130	30	34	39,8	76	7.50€
S04HD4132	32	36	42	76	8.30€

S04HD4115

45.00€

Jogo de 10 chaves de caixa longas de 1/2" - 6 faces

Composição:

S04HD4 Chaves: 10; 11; 13; 14; 15; 17; 19; 21; 22 e 24mm

S04H61

Chave de caixa sextavada 3/4"

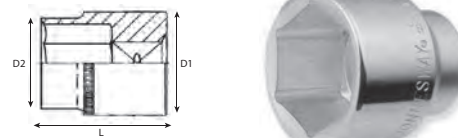

Ref.	Medida (mm)	D1 (mm)	D2 (mm)	L (mm)	Preço
S04H6119	19	30	36	49,5	5.60€
S04H6121	21	32	36	49,5	5.60€
S04H6122	22	33	36	49,5	5.60€
S04H6124	24	35	36	49,5	6.10€
S04H6127	27	38	36	52	6.60€
S04H6128	28	39	36	52	6.60€
S04H6130	30	42	38	54	7.20€
S04H6132	32	44	38	56	7.50€
S04H6134	34	46	38	58	9.30€
S04H6136	36	50	42	58	9.50€
S04H6138	38	52	45	60	10.10€
S04H6141	41	56	45	64	11.10€
S04H6146	46	62	48	68	13.50€
S04H6150	50	68	48	72	14.90€
S04H6152	52	69	48	73	21.00€

S04H63

Chave de caixa 3/4" - 12 faces

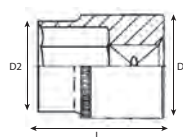

Ref.	Medida (mm)	D1 (mm)	D2 (mm)	L (mm)	Preço
S04H6319	19	30	36	49,5	5.30€
S04H6321	21	32	36	49,5	5.50€
S04H6322	22	33	36	49,5	5.50€
S04H6323	23	34	36	49,5	5.50€
S04H6324	24	35	36	49,5	5.80€
S04H6325	25	37	36	50	6.30€
S04H6326	26	37	36	50	6.40€
S04H6327	27	38	36	52	6.50€
S04H6329	29	40	38	53	6.80€
S04H6330	30	42	38	54	7.30€
S04H6332	32	44	38	56	7.50€
S04H6334	34	46	38	58	9.00€
S04H6336	36	50	42	58	9.60€
S04H6338	38	52	45	60	9.80€
S04H6341	41	56	45	64	11.50€
S04H6346	46	62	48	68	14.00€
S04H6350	50	68	48	72	15.50€
S04H6355	55	74	48	76	19.70€
S04H6356	56	75	48	76	19.90€
S04H6360	60	70	48	78	22.00€
S04H6365	65	87	60	85	34.00€

S04H64

Chave de caixa 3/4" - 12 faces (em polegadas)

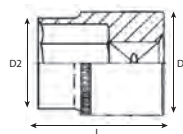

Ref.	Medida	D1 (mm)	D2 (mm)	L (mm)	Preço
S04H6419	3/4"	30	36	49,5	6.50€
S04H6421	13/16"	32	36	49,5	6.50€
S04H6422	7/8"	33	36	49,5	6.50€
S04H6424	15/16"	34	36	49,5	6.50€
S04H6426	1"	35	36	49,5	6.70€
S04H6427	1-1/16"	38	36	52	6.70€
S04H6429	1-1/8"	40	38	53	7.00€
S04H6430	1-3/16"	42	38	54	7.00€
S04H6432	1-1/4"	44	38	56	7.20€
S04H6433	1-5/16"	46	38	56	7.40€
S04H6435	1-3/8"	48	42	58	8.60€
S04H6436	1-7/16"	50	42	58	8.80€
S04H6438	1-1/2"	52	45	60	9.50€
S04H6440	1-9/16"	52	45	60	10.50€
S04H6441	1-5/8"	56	45	64	10.50€
S04H6443	1-11/16"	56	45	64	11.20€
S04H6444	1-3/4"	56	45	64	11.70€
S04H6446	1-13/16"	62	48	68	12.30€
S04H6447	1-7/8"	62	48	68	15.50€
S04H6450	2"	68	48	72	15.70€
S04H6456	2/14"	75	48	76	20.40€



S04H83

Chave de caixa 1" - 12 faces

Ref.	Medida (mm)	D1 (mm)	D2 (mm)	L (mm)	Preço
S04H8355	55	76	57	80	28.00€
S04H8360	60	82	57	84	33.00€
S04H8365	65	88	57	87	37.00€

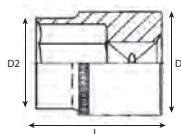
S05H4113S

35.50€

Jogo de 13 chaves de caixa de 1/2" - 12 faces

Composição:

S05H4 Chaves: 10; 12; 13; 14; 15; 16; 17; 18; 19; 20; 21; 22 e 24mm

S05H4213S

44.00€

Jogo de 13 chaves de caixa de 1/2" SAE

Composição:

Chaves: 3/8"; 7/16"; 1/2"; 9/16"; 5/8"; 11/16"; 3/4"; 13/16"; 7/8"; 15/16"; 1"; 1-1/16" e 1-1/8"

S05HD41

Chave de caixa sextavada longa 1/2"

Ref.	Medida (mm)	D1 (mm)	D2 (mm)	L (mm)	Preço
S05HD4110	10	21,8	15,4	76	3.50€
S05HD4111	11	21,8	16,7	76	3.50€
S05HD4112	12	21,8	18	76	3.60€
S05HD4113	13	21,8	19	76	3.70€
S05HD4117	17	23,8	23,8	76	3.80€
S05HD4118	18	24,8	16,7	76	4.00€
S05HD4119	19	25,8	25,8	76	4.00€
S05HD4120	20	27,9	27,9	76	4.20€
S05HD4121	21	27,9	27,9	76	4.40€
S05HD4122	22	30	30	76	4.50€
S05HD4123	23	31,8	31,8	76	5.30€
S05HD4124	24	31,8	31,8	76	6.70€
S05HD4127	27	36	36	76	7.70€
S05HD4130	30	40	40	76	7.70€
S05HD4132	32	42	42	76	8.30€

S05HD4113S

65.00€

Jogo de 13 chaves de caixa longas 1/2" - 6 faces

Composição:

S05HD4 Chaves: 11; 13; 14; 15; 17; 19; 21; 22; 23; 24; 27; 30 e 32mm

S06H37S

18.00€

Jogo de 7 chaves de caixa para parafusos torx 3/8"

Composição:

S06H3 Chaves: E10; E11; E12; E14; E16; E18 e E20

S05HD4213S

53.00€

Jogo de 13 chaves de caixa longas 1/2" SAE

Composição:

Chaves: 7/16"; 1/2"; 9/16"; 5/8"; 11/16"; 3/4"; 13/16"; 7/8"; 15/16"; 1"; 1-1/16"; 1-1/8" e 1-1/4"

S06H49S

28.50€

Jogo de 9 chaves de caixa para parafusos torx 1/2"

Composição:

S06H4 Chaves: E10; E11; E12; E14; E16; E18; E20; E22 e E24



Ferramenta de aperto

S66H41

Chaves de caixa de 1/2" - 12 faces



Ref.	Medida (mm)	Preço
S66H4108	8	1.35€
S66H4110	10	1.45€
S66H4111	11	1.50€
S66H4112	12	1.50€
S66H4113	13	1.55€
S66H4114	14	1.55€
S66H4115	15	1.55€
S66H4116	16	1.60€
S66H4117	17	1.70€
S66H4118	18	1.85€
S66H4119	19	1.85€
S66H4120	20	2.35€
S66H4121	21	2.35€
S66H4122	22	2.55€
S66H4124	24	3.20€
S66H4125	25	3.65€
S66H4126	26	4.10€
S66H4127	27	4.20€
S66H4128	28	4.30€
S66H4130	30	4.60€
S66H4132	32	5.60€
S66H4136	36	7.70€

S66HD41

Chaves de caixa longas de 1/2" - 12 faces



Ref.	Medida (mm)	Preço
S66HD4110	10	2.35€
S66HD4111	11	2.60€
S66HD4112	12	2.60€
S66HD4113	13	2.70€
S66HD4114	14	2.70€
S66HD4115	15	2.70€
S66HD4116	16	2.80€
S66HD4117	17	2.90€
S66HD4118	18	3.20€
S66HD4119	19	3.20€
S66HD4120	20	3.30€
S66HD4121	21	3.50€
S66HD4122	22	4.00€
S66HD4123	23	4.00€
S66HD4124	24	4.20€
S66HD4127	27	5.00€
S66HD4130	30	6.70€
S66HD4132	32	7.30€



 PHILLIPS	 FENDA	 TORX	 TORX TEMP.	 HEXAGONAL	 XZN
--	---	--	--	---	---

S06H2

Chave de caixa torx 1/4"

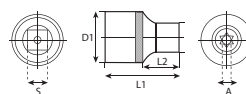

Ref.	Medida	D1 (mm)	D2 (mm)	L1 (mm)	L2 (mm)	Preço
S06H204	E4	12	6,2	25	11	1.20€
S06H205	E5	12	7,2	25	11	1.30€
S06H206	E6	12	8,2	25	11	1.30€
S06H207	E7	12	9	25	11	1.30€
S06H208	E8	12	10,3	25	11	1.30€
S06H210	E10					1.30€
S06H211	E11					1.30€

S06H3

Chave de caixa torx 3/8"



Ref.	Medida	D1 (mm)	D2 (mm)	L1 (mm)	Preço
S06H306	E6	17	11,2	28	1.70€
S06H307	E7	17	11,2	28	1.70€
S06H308	E8	17	11,2	28	1.70€
S06H310	E10	17	13,2	28	1.70€
S06H311	E11	17	13,8	28	1.70€
S06H312	E12	17	14,8	28	1.70€
S06H314	E14	18	16,8	28	1.70€
S06H316	E16	20	18,8	28	1.70€
S06H318	E18	22	20,8	28	1.70€
S06H320	E20	24	22,8	28	1.90€

S06H4

Chave de caixa torx 1/2"



Ref.	Medida	D1 (mm)	D2 (mm)	L1 (mm)	L2 (mm)	Preço
S06H410	E10	22	13,2	38	17	2.30€
S06H411	E11	22	13,9	38	17	2.30€
S06H412	E12	22	15	38	17	2.30€
S06H414	E14	22	16,7	38	17	2.40€
S06H416	E16	22	18,8	38	17	2.45€
S06H418	E18	22	20,8	38	17	2.45€
S06H420	E20	22	23	38	17	2.60€
S06H422	E22	22	25	38	17	2.65€
S06H424	E24	22	27	38	17	3.20€

S07H2



Chave de caixa bit torx 1/4" - 37mm



Ref.	Medida	L1 (mm)	L2 (mm)	L3 (mm)	L (mm)	D (mm)	d (mm)	Preço
S07H206	T6	13	19	25	37	12	10,8	1.10€
S07H207	T7	13	19	25	37	12	10,8	1.10€
S07H208	T8	13	19	25	37	12	10,8	1.10€
S07H209	T9	13	19	25	37	12	10,8	1.10€
S07H210	T10	13	19	25	37	12	10,8	1.10€
S07H215	T15	13	19	25	37	12	10,8	1.10€
S07H220	T20	13	19	25	37	12	10,8	1.10€
S07H225	T25	13	19	25	37	12	10,8	1.10€
S07H227	T27	13	19	25	37	12	10,8	1.10€
S07H230	T30	13	19	25	37	12	10,8	1.10€
S07H240	T40	13	19	25	37	12	10,8	1.10€

S07H3



Chave de caixa bit torx 3/8" - 48mm

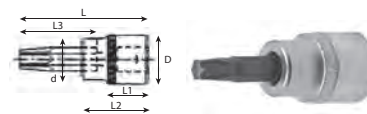

Ref.	Medida	L1 (mm)	L2 (mm)	L3 (mm)	L (mm)	D (mm)	d (mm)	Preço
S07H310	T10	16,5	26	30	48	18	13,8	1.30€
S07H315	T15	16,5	26	30	48	18	13,8	1.30€
S07H320	T20	16,5	26	30	48	18	13,8	1.30€
S07H325	T25	16,5	26	30	48	18	13,8	1.30€
S07H327	T27	16,5	26	30	48	18	13,8	1.30€
S07H330	T30	16,5	26	30	48	18	13,8	1.30€
S07H340	T40	16,5	26	30	48	18	13,8	1.30€
S07H345	T45	16,5	26	30	48	18	15,8	1.50€
S07H350	T50	16,5	26	30	48	18	15,8	1.50€
S07H355	T55	16,5	26	30	48	18	16,1	1.60€
S07H360	T60	16,5	26	30	48	18	16,1	1.80€

S07H4



Chave de caixa bit torx 1/2" - 55mm



Ref.	Medida	L1 (mm)	L2 (mm)	L3 (mm)	L (mm)	D (mm)	d (mm)	Preço
S07H420	T20	20	38	30	55	22	15	2.30€
S07H425	T25	20	38	30	55	22	15	2.30€
S07H427	T27	20	38	30	55	22	15	2.45€
S07H430	T30	20	38	30	55	22	15	2.45€
S07H440	T40	20	38	30	55	22	15	2.45€
S07H445	T45	20	38	30	55	22	15	2.50€
S07H450	T50	20	38	30	55	22	15	2.50€
S07H455	T55	20	38	30	55	22	17	2.50€
S07H460	T60	20	38	30	55	24	22	2.70€
S07H470	T70	20	38	30	55	24	22	2.90€



S07H43

Chave de caixa bit torx 1/2" - 100mm

Ref.	Medida	L1 (mm)	L2 (mm)	L3 (mm)	L (mm)	D (mm)	d (mm)	Preço
S07H4320	T20	20	38	75	100	24	15	3.40€
S07H4325	T25	20	38	75	100	24	15	3.40€
S07H4327	T27	20	38	75	100	24	15	3.40€
S07H4330	T30	20	38	75	100	24	15	3.50€
S07H4340	T40	20	38	75	100	24	15	3.50€
S07H4345	T45	20	38	75	100	24	15	3.50€
S07H4350	T50	20	38	75	100	24	15	3.50€
S07H4352	T52	20	38	75	100	24	15	3.50€
S07H4355	T55	20	38	75	100	24	17	3.50€
S07H4360	T60	20	38	75	100	24	22	3.90€
S07H4370	T70	20	38	75	100	24	22	4.00€

S07H45

Chave de caixa bit torx de 1/2"

Ref.	Medida	Comp. (mm)	Preço
S07H4530	T30	200	5.80€
S07H4540	T40	200	5.80€
S07H4545	T45	200	5.80€

S08H311S

15.00€

Jogo de 11 bits de 1/4" e 3/8" torx tamperproof

Composição:

Chaves de 1/4": T8; T10; T15; T20; T25 e T27

Chaves de 3/8": T30; T40; T45; T50 e T55

S09H2

Chave de caixa bit hexagonal 1/4" - 37mm

Ref.	Medida	L1 (mm)	L2 (mm)	L3 (mm)	L (mm)	D (mm)	d (mm)	Preço
S09H203	H3	13	19	25	37	12	10,8	1.15€
S09H204	H4	13	19	25	37	12	10,8	1.15€
S09H205	H5	13	19	25	37	12	10,8	1.15€
S09H206	H6	13	19	25	37	12	10,8	1.15€
S09H207	H7	13	19	25	37	12	10,8	1.25€

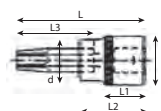
S09H3

Chave de caixa bit hexagonal 3/8" - 48mm

Ref.	Medida	L1 (mm)	L2 (mm)	L3 (mm)	L (mm)	D (mm)	d (mm)	Preço
S09H303	H3	16,5	26	30	48	18	13,8	1.35€
S09H304	H4	16,5	26	30	48	18	13,8	1.35€
S09H305	H5	16,5	26	30	48	18	13,8	1.35€
S09H306	H6	16,5	26	30	48	18	13,8	1.35€
S09H307	H7	16,5	26	30	48	18	15,8	1.35€
S09H308	H8	16,5	26	30	48	18	15,8	1.50€
S09H310	H10	16,5	26	30	48	18	16,1	1.50€
S09H312	H12	16,5	26	30	48	18	16,1	1.70€
S09H314	H14	16,5	26	30	48	18	16,1	1.95€



S09H4



Chave de caixa bit hexagonal 1/2" - 55mm



Ref.	Medida	L1 (mm)	L2 (mm)	L3 (mm)	L (mm)	D (mm)	d (mm)	Preço
S09H404	H4	20	38	30	55	24	15	2.50€
S09H405	H5	20	38	30	55	24	15	2.50€
S09H406	H6	20	38	30	55	24	15	2.50€
S09H407	H7	20	38	30	55	24	15	2.50€
S09H408	H8	20	38	30	55	24	15	2.50€
S09H410	H10	20	38	30	55	24	17,8	2.60€
S09H412	H12	20	38	30	55	24	22	2.90€
S09H414	H14	20	38	30	55	24	22	2.90€
S09H416	H16	20	38	30	55	24	22	3.10€
S09H417	H17	20	38	30	55	24	22	3.75€
S09H419	H19	20	38	30	55	24	22	4.15€



S09H43



Chave de caixa bit hexagonal 1/2" - 100mm



Ref.	Medida	L1 (mm)	L2 (mm)	L3 (mm)	L (mm)	D (mm)	d (mm)	Preço
S09H4304	H4	20	38	75	100	24	15	3.45€
S09H4305	H5	20	38	75	100	24	15	3.45€
S09H4306	H6	20	38	75	100	24	15	3.50€
S09H4307	H7	20	38	75	100	24	15	3.50€
S09H4308	H8	20	38	75	100	24	15	3.50€
S09H4309	H9	20	38	75	100	24	15	3.65€
S09H4310	H10	20	38	75	100	24	20,8	3.65€
S09H4312	H12	20	38	75	100	24	22	3.70€
S09H4314	H14	20	38	75	100	24	22	3.90€
S09H4316	H16	20	38	75	100	24	22	4.65€
S09H4317	H17	20	38	75	100	24	22	5.10€
S09H4319	H19	20	38	75	100	24	22	7.30€

S10H2



Chave de caixa bit fenda 1/4" - 37mm

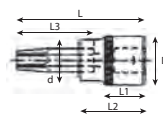

Ref.	Medida (mm)	L1 (mm)	L2 (mm)	L3 (mm)	L (mm)	D (mm)	d (mm)	Preço
S10H230	3	13	21	25	37	12	10,8	1.15€
S10H235	3,5	13	21	25	37	12	10,8	1.15€
S10H240	4	13	21	25	37	12	10,8	1.15€
S10H245	4,5	13	21	25	37	12	10,8	1.15€
S10H250	5	13	21	25	37	12	10,8	1.15€
S10H255	5,5	13	21	25	37	12	10,8	1.15€
S10H260	6	13	21	25	37	12	10,8	1.15€
S10H270	7	13	21	25	37	12	10,8	1.25€



S10H3

Chave de caixa bit fenda 3/8" - 48mm



Ref.	Medida (mm)	L1 (mm)	L2 (mm)	L3 (mm)	L (mm)	D (mm)	d (mm)	Preço
S10H340	4	15,5	26,5	30	48	18	13,8	1.20€
S10H350	5	15,5	26,5	30	48	18	13,8	1.20€
S10H355	5,5	15,5	26,5	30	48	18	13,8	1.25€
S10H360	6	15,5	26,5	30	48	18	13,8	1.25€
S10H370	7	15,5	26,5	30	48	18	13,8	1.25€
S10H380	8	15,5	26,5	30	48	18	15,8	1.25€
S10H3100	10	15,5	26,5	30	48	20	17,8	1.45€
S10H3120	12	15,5	26,5	30	48	20	17,8	1.75€

S10H4

Chave de caixa bit fenda 1/2" - 55mm



Ref.	Medida (mm)	L1 (mm)	L2 (mm)	L3 (mm)	L (mm)	D (mm)	d (mm)	Preço
S10H480	8	20	36	30	55	22	17,8	2.40€
S10H490	9	20	36	30	55	22	17,8	2.60€
S10H4100	10	20	36	30	55	22	17,8	2.65€
S10H4110	11	20	36	30	55	24	20,8	2.75€
S10H4120	12	20	36	30	55	24	20,8	2.75€

S11H2

Chave de caixa bit phillips 1/4" - 37mm



Ref.	Medida	L1 (mm)	L2 (mm)	L3 (mm)	L (mm)	D (mm)	d (mm)	Preço
S11H200	PH0	13	19	25	37	12	10,8	1.15€
S11H201	PH1	13	19	25	37	12	10,8	1.15€
S11H202	PH2	13	19	25	37	12	10,8	1.15€
S11H203	PH3	13	19	25	37	12	10,8	1.15€

S11H3

Chave de caixa bit phillips 3/8" - 48mm

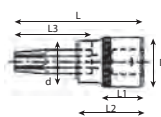

Ref.	Medida	L1 (mm)	L2 (mm)	L3 (mm)	L (mm)	D (mm)	d (mm)	Preço
S11H300	PH0	16,5	26	30	48	18	13,8	1.25€
S11H301	PH1	16,5	26	30	48	18	13,8	1.25€
S11H302	PH2	16,5	26	30	48	18	13,8	1.25€
S11H303	PH3	16,5	26	30	48	18	15,8	1.25€
S11H304	PH4	16,5	26	30	48	18	15,8	1.45€

S11H4

Chave de caixa bit phillips 1/2" - 55mm



Ref.	Medida	L1 (mm)	L2 (mm)	L3 (mm)	L (mm)	D (mm)	d (mm)	Preço
S11H402	PH2	55	38	30	55	24	15	2.40€
S11H403	PH3	55	38	30	55	24	15	2.40€
S11H404	PH4	55	38	30	55	24	15	2.40€

S49H4



Chave de caixa bits estriado XZN de 1/2"

Ref.	Medida	Comp. (mm)	Preço
S49H4105	M5	55	3.10€
S49H4106	M6	55	3.20€
S49H4108	M8	55	3.20€
S49H4110	M10	55	3.20€
S49H4112	M12	55	3.30€
S49H4114	M14	55	3.90€
S49H4116	M16	55	5.40€
S49H4308	M8	100	4.50€
S49H4310	M10	100	4.80€
S49H4312	M12	100	4.90€
S49H4314	M14	100	6.00€
S49H4318	M18	100	8.80€

S50H3106S



13.00€

Jogo de 6 bits hexagonais 3/8"

Composição:

Chaves: 4; 5; 6; 7; 8 e 10 mm



S50H3206S



12.60€

Jogo de 6 bits hexagonais 3/8" SAE

Composição:

Chaves: 5/32"; 3/16"; 7/32"; 1/4"; 5/16" e 3/8"



S54H5509S



15.00€

Jogo de 9 chaves de torx de 1/4" e 3/8"

Composição:

S54H2 Chaves de 1/4": T10; T15; T20 e T25

S54H3 Chaves de 3/8": T25; T30; T40; T45 e T50



S63H33



Chave de caixa Ribe 3/8" - 90mm

Ref.	Medida	Comp. (mm)	Preço
S63H3306	M6	90	1.70€
S63H3307	M7	90	2.00€
S63H3308	M8	90	2.00€
S63H3310	M10	90	2.65€

S63H43



Chave de caixa Ribe 1/2" - 100mm

Ref.	Medida	Comp. (mm)	Preço
S63H4306	M6	100	3.30€
S63H4307	M7	100	3.40€
S63H4308	M8	100	3.50€
S63H4310	M10	100	3.70€
S63H4312	M12	100	3.90€
S63H4313	M13	100	4.00€

S63H44



Chave de caixa Ribe 1/2" - 55mm

Ref.	Medida	Comp. (mm)	Preço
S63H4405	M5	55	2.60€
S63H4406	M6	55	2.70€
S63H4407	M7	55	2.70€
S63H4408	M8	55	2.75€
S63H4409	M9	55	2.95€
S63H4410	M10	55	3.10€
S63H4412	M12	55	3.50€
S63H4413	M13	55	4.10€
S63H4414	M14	55	4.80€

S63H4507S

23.50€

Jogo de 7 bits longos 6 caneluras (Ribe) 3/8" e 1/2"

Composição:

Bits 3/8" de 90 mm: M6; M7; M8 e M10

Bits 1/2" de 100 mm: M12; M13 e M14



S63H46



Chave de caixa Ribe 1/2" - 100mm

Ref.	Medida	Comp. (mm)	Preço
S63H4605	M5	100	3.30€
S63H4606	M6	100	3.40€
S63H4607	M7	100	3.40€
S63H4608	M8	100	3.50€
S63H4609	M9	100	3.60€
S63H4610	M10	100	3.60€
S63H4612	M12	100	4.10€
S63H4613	M13	100	5.20€
S63H4614	M14	100	5.50€



S63H47

Chave de caixa Ribe 1/2" - 140mm

Ref.	Medida	Comp. (mm)	Preço
S63H4708	M8	140	4.10€
S63H4709	M9	140	4.10€
S63H4710	M10	140	4.10€
S63H4712	M12	140	5.20€
S63H4713	M13	140	6.00€
S63H4714	M14	140	6.00€

S63H48

Chave de caixa Ribe 1/2" - 200mm

Ref.	Medida	Comp. (mm)	Preço
S63H4808	M8	200	4.80€
S63H4809	M9	200	4.90€
S63H4810	M10	200	5.00€
S63H4812	M12	200	6.20€
S63H4813	M13	200	7.30€
S63H4814	M14	200	7.40€

C-DMH

Barra magnética para chaves de caixa

Ref.	Medida	Capacid. (chaves)	Preço
C-DMH212	1/4"	12	16.00€
C-DMH314	3/8"	14	25.00€
C-DMH414	1/2"	12	26.00€

MSH

Régua suporte para chaves de caixa

Ref.	Medida	Capacid. (chaves)	Preço
MSH1214	1/2"	14	2.30€
MSH1414	1/4"	14	1.90€
MSH3814	3/8"	14	2.10€

S15H

Cardan

Ref.	Medida	D1 (mm)	D2 (mm)	L (mm)	Acabamento	Preço
S15H240	1/4"	14	14	35	Mate	2.60€
S15H356	3/8"	18	18	49	Mate	3.90€
S15H472	1/2"	25	25	69	Mate	5.00€
S15H6109	3/4"	39,7	39,5	106,2	Polido	25.00€

S64H4

Chave de caixa bits estriado XZN de 1/2"

Ref.	Medida	Comp. (mm)	Preço
S64H4104	M4	55	2.80€
S64H4105	M5	55	2.80€
S64H4106	M6	55	2.80€
S64H4107	M7	55	2.80€
S64H4109	M9	55	2.80€
S64H4112	M12	55	3.40€
S64H4113	M13	55	4.10€
S64H4114	M14	55	4.30€
S64H4204	M4	100	3.30€
S64H4205	M5	100	3.30€
S64H4206	M6	100	3.40€
S64H4207	M7	100	3.40€
S64H4208	M8	100	3.50€
S64H4209	M9	100	3.50€
S64H4210	M10	100	3.60€
S64H4212	M12	100	4.20€
S64H4214	M14	100	5.30€
S64H4216	M16	100	6.10€
S64H4218	M18	100	10.30€
S64H4705	M5	140	3.90€
S64H4706	M6	140	3.90€
S64H4708	M8	140	4.20€
S64H4709	M9	140	4.20€
S64H4710	M10	140	4.20€
S64H4712	M12	140	5.00€
S64H4714	M14	140	6.00€
S64H4808	M8	200	4.80€
S64H4810	M10	200	4.80€
S64H4812	M12	200	6.10€
S64H4814	M14	200	7.00€



S16H
Adaptador

Ref.	Medida	A (mm)	D1 (mm)	D2 (mm)	L (mm)	Acabamento	Preço
S16H1234	1/2" F - 3/4" M	19	12,7	27	45	Polido	4.40€
S16H1238	1/2" F - 3/8" M	9,52	12,7	22	34	Mate	1.45€
S16H1438	1/4" F - 3/8" M	9,52	6,35	14	25	Mate	1.15€
S16H3410	3/4" F - 1" M	25,3	19,05	39,7	59,6	Polido	11.20€
S16H3412	3/4" F - 1/2" M	12,7	19,05	35	51	Polido	6.80€
S16H3812	3/8" F - 1/2" M	12,7	9,52	17	35	Mate	1.35€
S16H3814	3/8" F - 1/4" M	6,35	9,75	18,6	28	Mate	1.10€

S16H
Adaptador

Ref.	Medida	A (mm)	D1 (mm)	D2 (mm)	L (mm)	Acabamento	Preço
S16H302	1/4" M - 3/8" F	6,35	9,75	18,6	28	Mate	2.15€
S16H304	1/2" M - 3/8" F	12,7	9,75	23,5	43,7	Mate	3.20€
S16H403	3/8" M - 1/2" F	9,5	12,9	23,5	40	Mate	3.15€

S17H
Chave de velas

Ref.	Medida	A (mm)	D1 (mm)	D2 (mm)	L (mm)	Acabamento	Preço
S17H3116	3/8"	9,525	21,7	18,8	65	Mate	1.70€
S17H3121	3/8"	9,525	27,6	21,5	65	Mate	2.30€
S17H4116	1/2"	12,7	21,8	21,8	65	Mate	1.65€
S17H4121	1/2"	12,7	27,6	23,6	65	Mate	2.30€

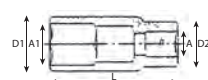
S17H3414
6.00€
Chave de velas 12 faces 3/8"

 Medida: 14mm
 Acabamento: Mate

S21H
Extensão

Ref.	Quadra	Medida (mm)	Acabamento	Preço
S21H4150	1/2"	50	Mate	3.30€
S21H4175	1/2"	75	Mate	3.90€
S21H41125	1/2"	125	Mate	4.70€
S21H41250	1/2"	250	Mate	7.00€

S22H
Cabo articulado

Ref.	Quadra	Medida (mm)	Acabamento	Preço
S22H21130	1/4"	130	Mate	5.70€
S22H31200	3/8"	200	Mate	7.90€
S22H41375	1/2"	375	Mate	15.50€
S22H41450	1/2"	450	Mate	19.50€

S22H
Cabo articulado

Ref.	Quadra	Medida (mm)	Acabamento	Preço
S22H41600	1/2"	600	Polido	24.70€
S22H6500	3/4"	500	Polido	39.00€

S22H41600RK
9.80€
Kit de reparação para cabo articulado S22H41600

S22H6500RK
15.50€
Kit de reparação para cabo articulado S22H6500

S22H21130RK
2.70€
Kit de reparação para cabo articulado S22H21130

S22H41375RK
3.20€
Kit de reparação para cabo articulado S22H41375 e S22H41450

S23H

Cabo "T" corrediço

Ref.	Quadra	Medida (mm)	Acabamento	Preço
S23H21115	1/4"	115	Mate	2.10€
S23H31200	3/8"	200	Mate	4.60€
S23H41250	1/2"	250	Mate	6.10€
S23H41300	1/2"	300	Mate	6.80€
S23H6450	3/4"	450	Polido	22.50€
S23H6500	3/4"	500	Polido	24.50€
S23H8550	1"	550	Polido	46.00€

S24H

Extensões

Ref.	Quadra	Medida (mm)	Acabamento	Preço
S24H250	1/4"	50	Mate	1.20€
S24H375	3/8"	75	Mate	1.80€
S24H450	1/2"	50	Mate	2.50€
S24H475	1/2"	75	Mate	3.00€
S24H2100	1/4"	100	Mate	1.35€
S24H2150	1/4"	150	Mate	1.55€
S24H3150	3/8"	150	Mate	2.50€
S24H3200	3/8"	200	Mate	2.80€
S24H3250	3/8"	250	Mate	3.65€
S24H4125	1/2"	125	Mate	3.70€
S24H4224	1/2"	610	Polido	22.50€
S24H4250	1/2"	250	Mate	4.60€
S24H6100	3/4"	100	Polido	10.30€
S24H6200	3/4"	200	Polido	13.80€
S24H6400	3/4"	400	Polido	24.30€
S24H8200	1"	200	Polido	27.00€

S26H2150
2.70€
Punho de 1/4"

S26H2280
13.00€
Punho 1/4" dupla função fixo/ cardan

AG010184F
5.80€
Chave flexível ponta macho de 1/4"

Ferramenta de aperto
AG0101

Chave flexível de punho com caixa

Ref.	Quadra	Medida (mm)	Preço
AG010184B		6	6.50€
AG010184C		7	6.50€
AG010184D		8	6.50€
AG010184E		10	6.50€

S27H

Extensões flexíveis

Ref.	Quadra	Medida (mm)	Preço
S27H2	1/4"	145	2.50€
S27H3	3/8"	193	18.50€
S27H4	1/4"	205	18.00€

S40H

Chave em T

Ref.	Medida (mm)	Comp. (mm)	Comp. Punho (mm)	Preço
S40H108	8	300	200	10.00€
S40H110	10	300	200	10.00€
S40H112	12	300	200	10.00€
S40H114	14	300	200	10.00€

S40T

Chave em T com ponta flexível

Ref.	Medida (mm)	Preço
S40T108	8	22.00€
S40T110	10	22.00€
S40T112	12	22.00€
S40T113	13	22.00€
S40T114	14	22.00€
S40T117	17	22.00€
S40T119	19	22.00€

S40T109S
142.00€
Jogo de 9 peças "T" flexíveis

 Composição/ medidas em mm:
 8; 10; 12; 13; 14; 17 e 19
 Travessões P/T

S41H41
11.50€
Manivela quadra macho de 1/2"

S42M

Extensões magnéticas



Ref.	Quadra	Medida (mm)	Preço
S42M475	1/2"	75	9.20€
S42M4125	1/2"	125	9.20€
S42M4250	1/2"	250	13.00€

S42M403S

31.00€

Jogo de 3 extensões magnéticas 1/2"

Composição/ medidas em mm:
75; 125 e 250



S44H2206

1.00€

Porta bits 1/4"

Quadra de 1/4" para uso em bits com encabadouro de 1/4"



S44H3110A

2.60€

Porta bits

Quadra: 3/8"

Utilização em bits: 3/8"



S44H3206

2.10€

Porta bits

Quadra: 3/8"

Utilização em bits: 1/4"



S44H4110

1.90€

Porta bits

Quadra: 1/2"

Utilização em bits: 3/8"



S60H4304S

40.00€

Jogo de 4 extensões de 1/2"

Composição/ medidas em mm:
75; 125; 250 e 375



R53A-3

Adaptador "macho/macho"

Para aplicação em conjunto com o cabo "T" flexível R53A

Ref.	Quadra	Compr. (mm)	Preço
R53A-2A	1/4"	20	1.10€
R53A-3A	3/8"	30	1.60€
R53A-4A	1/2"	35	2.10€



R19H3

Chave pata de galo 3/8"

Ref.	Medida (mm)	Preço
R19H3110	10	4.90€
R19H3111	11	4.90€
R19H3112	12	4.90€
R19H3113	13	4.90€
R19H3114	14	4.90€
R19H3115	15	4.90€
R19H3116	16	5.10€
R19H3117	17	5.20€
R19H3118	18	5.30€
R19H3119	19	5.40€



R19H310S

45.00€

Jogo de 10 chaves pata de galo de 3/8"

Composição/ medidas em mm:

Chaves: 10; 11; 12; 13; 14; 15; 16; 17; 18 e 19



S03A4111S

39.00€

Jogo de 11 chaves de impacto de 1/2"

Composição/ medidas (mm):

S03A4 Chaves: 10; 11; 12; 13; 14; 16; 17; 19; 21; 22 e 24



S01U41
Cardan de impacto 1/2"

Ref.	Medida (mm)	Compr. (mm)	Preço
S01U4113	13	70	11.80€
S01U4114	14	70	11.90€
S01U4115	15	70	11.90€
S01U4116	16	70	11.90€
S01U4117	17	70	11.90€
S01U4119	19	70	12.80€
S01U4121	21	70	13.40€
S01U4122	22	70	14.00€

S01U4108S
103.00€
Jogo 8 chaves/ cardans impacto 1/2"

 Composição/ medidas em mm:
 Chaves: 13; 14; 15; 16;
 17; 19; 21 e 22

S03A2
Chave de impacto 1/4"

Ref.	Quadra	Medida (mm)	Preço
S03A2110	1/4"	10	1.55€
S03A2112	1/4"	12	1.65€
S03A2114	1/4"	14	1.80€

S03AD4111S
61.00€
Jogo de 11 chaves de impacto longas de 1/2"

 Composição/ medidas (mm):
S03AD4 Chaves: 10; 11; 12; 13; 14; 16; 17; 19; 21; 22 e 24

S03A4A
Adaptador de 1/2"

Ref.	Quadra	Preço
S03A4A3	3/8"	4.20€
S03A4A6	3/4"	5.80€

S03A4U4
10.80€
Cardan de 1/2"

S03A4UT3S
33.00€
Jogo de 3 cardans impacto

 Composição/ medidas:
 1/4"; 3/8" e 1/2"

S03A
Cardan de impacto

Ref.	Quadra	Preço
S03A2UT	1/4"	8.40€
S03A3UT	3/8"	10.30€
S03A4UT	1/2"	13.50€

S03A4E
Extensão

Ref.	Quadra	Medida (mm)	Preço
S03A4E4	1/2"	100	5.30€
S03A4E5	1/2"	125	5.60€
S03A4E6	1/2"	150	6.90€
S03A4E8	1/2"	200	7.70€

S03A4211S
40.30€
Jogo de 11 chaves impacto 1/2" SAE

Composição:

Ref.	Medida	Ref.	Medida
S03A4210	3/8"	S03AD4219	3/4"
S03A4211	7/16"	S03AD4221	13/16"
S03A4213	1/2"	S03AD4222	7/8"
S03A4214	9/16"	S03AD4224	15/16"
S03A4216	5/8"	S03AD4226	1"
S03A4217	11/16"		



S03AD4414S
97.00€
Jogo de 14 chaves longas impacto 1/2" SAE

Composição/ medidas:

 Chaves: 3/8"; 7/16"; 1/2"; 9/16"; 5/8"; 11/16"; 3/4";
 13/16"; 7/8"; 15/16"; 1"; 1-1/16"; 1-1/8" e 1-1/4"

S03A4

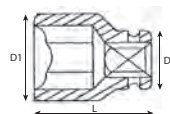
Chave impacto 1/2"



Ref.	Medida (mm)	D1 (mm)	D2 (mm)	L (mm)	Preço
S03A4109	9	15	24	38	2.80€
S03A4110	10	17	24	38	2.80€
S03A4111	11	19	24	38	2.90€
S03A4112	12	20	24	38	2.90€
S03A4113	13	20,8	24	38	2.95€
S03A4114	14	22	24	38	2.95€
S03A4115	15	24	24	38	3.00€
S03A4116	16	24	24	38	3.25€
S03A4117	17	26	26	38	3.35€
S03A4118	18	26	27	38	3.45€
S03A4119	19	28	28	38	3.60€
S03A4120	20	30	30	38	3.70€
S03A4121	21	30	30	38	3.80€
S03A4122	22	32	30	38	4.00€
S03A4123	23	34	30	38	4.30€
S03A4124	24	34	30	43	4.60€
S03A4127	27	38	30	43	6.50€
S03A4129	29	40	30	48	7.40€
S03A4130	30	42	30	48	7.60€
S03A4132	32	44,6	30	48	8.00€

S03AD4

Chave impacto longa 1/2"

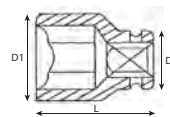

Ref.	Medida (mm)	D1 (mm)	D2 (mm)	L (mm)	Preço
S03AD4110	10	17	24	78	4.80€
S03AD4111	11	19	24	78	4.80€
S03AD4112	12	19,6	24	78	4.80€
S03AD4113	13	20,8	24	78	4.80€
S03AD4114	14	22	24	78	4.80€
S03AD4115	15	24	24	78	4.85€
S03AD4116	16	24	24	78	4.90€
S03AD4117	17	26	26	78	5.20€
S03AD4118	18	28	27	78	5.50€
S03AD4119	19	28	28	78	5.60€
S03AD4120	20	30	30	78	5.70€
S03AD4121	21	30	30	78	6.20€
S03AD4122	22	32	30	78	6.50€
S03AD4123	23	33,3	30	78	6.80€
S03AD4124	24	34,6	30	78	7.20€
S03AD4125	25	35,8	30	78	8.00€
S03AD4126	26	37	30	78	9.00€
S03AD4127	27	38	30	78	9.10€
S03AD4128	28	39,5	30	78	9.80€
S03AD4130	30	42	30	78	11.00€
S03AD4132	32	44,6	30	78	11.50€

S03A6
Chave impacto 3/4"

Ref.	Medida (mm)	D1 (mm)	D2 (mm)	L (mm)	Preço
S03A6126	26	41	38	51	7.20€
S03A6127	27	43	40	53	7.50€
S03A6129	29	45	42	53	7.90€
S03A6130	30	46	44	53	8.60€
S03A6132	32	49	44	57	9.30€
S03A6133	33	51	44	57	9.70€
S03A6134	34	51	44	57	10.10€
S03A6135	35	53	44	57	10.50€
S03A6136	36	54	44	57	11.40€
S03A6137	37	55	44	57	11.90€
S03A6138	38	56	44	57	12.10€
S03A6139	39	57,7	44	57	13.10€
S03A6140	40	59	44	57	14.30€
S03A6141	41	60	44	57	15.00€
S03A6142	42	61,4	44	57	17.10€
S03A6143	43	62,7	44	62	17.80€
S03A6144	44	64	44	62	19.00€
S03A6145	45	65	44	62	19.60€
S03A6146	46	66,4	44	62	19.80€
S03A6147	47	67,6	44	67	20.70€
S03A6148	48	68,8	44	67	21.00€
S03A6149	49	70	44	72	22.50€
S03A6150	50	71,4	72	72	24.00€
S03A6151	51	72,8	72	72	28.00€
S03A6152	52	74	72	72	29.00€
S03A6153	53	75	72	72	29.50€
S03A6154	54	76,4	72	72	30.00€
S03A6155	55	77,7	74	74	32.50€
S03A6156	56	79	74	74	34.50€
S03A6157	57	80	74	74	35.50€
S03A6158	58	81,5	75	75	38.00€
S03A6159	59	82,7	75	75	40.00€
S03A6160	60	84	75	75	42.50€
S03A6163	63	87,6	75	75	45.50€
S03A6165	65	90	78	78	48.00€
S03A6167	67	92,7	80	80	55.00€
S03A6170	70	96,4	83	83	57.00€

S03A6108S
82.00€
Jogo de 8 chaves de impacto de 3/4"

Composição/ medidas:

S03A6 Chaves: 26; 27; 29; 30; 32; 35; 36 e 38

S03AD6

Chave impacto longa 3/4"

Ref.	Medida (mm)	D1 (mm)	D2 (mm)	L (mm)	Preço
S03AD6124	24	38,9	44	90	16.00€
S03AD6126	26	41,3	44	90	16.50€
S03AD6127	27	42,6	44	90	17.00€
S03AD6129	29	45,1	44	90	17.00€
S03AD6130	30	46,4	44	90	17.00€
S03AD6132	32	48,9	44	90	17.50€
S03AD6133	33	50,6	44	90	18.00€
S03AD6134	34	51,4	44	90	18.00€
S03AD6135	35	52,7	44	90	18.50€
S03AD6136	36	53,9	44	90	20.00€
S03AD6138	38	56,4	44	90	21.50€
S03AD6140	40	58,9	44	90	24.50€
S03AD6141	41	60,1	44	90	25.00€
S03AD6142	42	61,4	44	90	28.50€
S03AD6144	44				30.50€
S03AD6146	46	66,4	44	90	32.50€
S03AD6150	50	71,4	54	90	38.00€



S03AD6107S

125.00€

Jogo de 7 chaves de impacto longas de 3/4"

Composição/ medidas:

S03AD6 Chaves: 26; 27; 29; 32; 35; 36 e 38



S03AD6120S

265.00€

Jogo de 20 peças de impacto de 3/4"

Composição/ medidas em mm:

S03AD6 Chaves: 24; 27; 30; 32; 33; 34; 35; 36; 41 e 46
 S03A4A6 Adaptador 1/2" - 3/4"
 S03A8A6 Adaptador 1" - 3/4"
 S03A6U6 Cardan 3/4"
 S03A6E Extensão de 3/4" 250 mm
 Pinos
 O'ring



S03A6A

Adaptador de 3/4"

Ref.	Quadra	Preço
S03A6A4	1/2"	11.20€
S03A6A8	1"	13.50€



S03A6U6

36.00€

Cardan de 3/4"



S03A6E

Extensão

Ref.	Quadra	Medida (mm)	Preço
S03A6E04	3/4"	100	18.50€
S03A6E08	3/4"	200	22.00€
S03A6E10	3/4"	250	26.00€

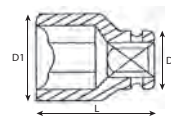

S03A8
Chave impacto 1"

Ref.	Medida (mm)	D1 (mm)	D2 (mm)	L (mm)	Preço
S03A8124	24	41,9	54	58	18.00€
S03A8127	27	45,6	54	58	18.50€
S03A8129	29	48,1	54	60	18.50€
S03A8130	30	49,4	54	60	18.50€
S03A8132	32	51,9	54	60	19.00€
S03A8133	33	53,6	54	60	19.00€
S03A8134	34	54,4	54	62	19.50€
S03A8135	35	55,7	54	62	20.00€
S03A8136	36	56,9	54	62	23.00€
S03A8138	38	59,4	54	65	23.00€
S03A8140	40	110	54	65	23.00€
S03A8141	41	63,1	54	65	24.00€
S03A8144	44	120	54	65	26.00€
S03A8146	46	69,4	54	74	27.00€
S03A8150	50	74,4	54	74	33.00€
S03A8155	55	80,7	54	85	40.00€
S03A8160	60	87,1	54	90	52.00€
S03A8165	65	93,2	54	90	62.00€
S03A8170	70	99,4	54	100	78.00€
S03A8173	73	103,3	86	100	91.00€
S03A8175	75	105,6	86	100	99.00€
S03A8176	76	106,9	86	100	115.00€
S03A8178	78	110	86	100	120.00€
S03A8180	80	111,9	86	100	125.00€
S03A8185	85	118,5	86	110	155.00€
S03A8189	89	123,2	86	110	157.00€
S03A8190	90	124,4	86	110	180.00€
S03A8192	92	126,8	86	110	185.00€
S03A8195	95	129	86	110	205.00€

S03A8109S
210.00€
Jogo de 9 chaves impacto 1"

Composição/ medidas:

S03A8 Chaves: 24; 27; 30; 32; 35; 38; 41; 46 e 50

S03A8A6
18.50€
Adaptador 1" - 3/4"

S03A8E
Extensão impacto

Ref.	Quadra	Medida (mm)	Preço
S03A8E04	1"	100	28.00€
S03A8E07	1"	175	34.00€
S03A8E10	1"	250	52.00€

S03AD8107S
186.00€
Jogo de 7 chaves longas de impacto 1"

Composição/ medidas:

S03AD8 Chaves: H5, H6, H8, H10, H12, H14, H17 e H19
Mala metálica

S03AD8

Chave impacto longa 1"



Ref.	Medida (mm)	D1 (mm)	D2 (mm)	L (mm)	Preço
S03AD8117	17	33,1	54	90	24.00€
S03AD8124	24	41,9	54	90	25.00€
S03AD8126	26	43,3	54	90	25.00€
S03AD8127	27	45,6	54	90	25.00€
S03AD8129	29	48,1	54	90	26.00€
S03AD8130	30	49,4	54	90	26.50€
S03AD8132	32	51,9	54	90	27.00€
S03AD8133	33	53,6	54	90	27.00€
S03AD8134	34	54,4	54	90	27.50€
S03AD8135	35	55,7	54	90	28.00€
S03AD8136	36	56,9	54	90	28.50€
S03AD8138	38	59,4	54	90	29.50€
S03AD8140	40	61,9	54	90	30.50€
S03AD8141	41	63,1	54	90	31.50€
S03AD8142	42	64,4	54	90	32.50€
S03AD8146	46	69,4	54	90	36.00€
S03AD8148	48	71,8	54	90	41.00€
S03AD8150	50	74,4	54	90	49.00€
S03AD8155	55	80,7	54	90	60.50€
S03AD8158	58	84,5	54	105	64.50€
S03AD8160	60	87,1	54	120	74.50€
S03AD8165	65	93,2	54	120	84.00€



S03S8

Chave de impacto quadrada



Ref.	Quadra	Medida (mm)	Preço
S03S8117	1"	17	18.00€
S03S8119	1"	19	18.50€
S03S8121	1"	21	18.50€

S03SD8

Chave de impacto longa quadrada



Ref.	Quadra	Medida (mm)	Preço
S03SD8117	1"	17	23.00€
S03SD8119	1"	19	24.00€
S03SD8121	1"	21	25.50€

S05A4H

Bit hexagonal de impacto 1/2"

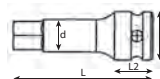

Ref.	Medida	D (mm)	d (mm)	L2 (mm)	L (mm)	Preço
S05A4H4	H4	25	6	22,5	78	7.90€
S05A4H5	H5	25	7	22,5	78	8.00€
S05A4H6	H6	25	8	22,5	78	8.10€
S05A4H7	H7	25	9	22,5	78	8.10€
S05A4H8	H8	25	10,5	22,5	78	8.15€
S05A4H10	H10	25	12,5	22,5	78	8.60€
S05A4H12	H12	25	15	22,5	78	8.60€
S05A4H14	H14	25	17,5	22,5	78	8.60€
S05A4H17	H17	25	21	22,5	78	8.60€
S05A4H18	H18	25	22	22,5	78	8.60€
S05A4H19	H19	25	23	22,5	78	8.65€

S05A408S
55.00€

Jogo de 8 chaves de caixa com ponta macho hexagonal de impacto 1/2"

Composição:

S05A4 Chaves: H5; H6; H8; h10; H12; H14; H17 e H19

S05A6105S
90.00€

Jogo de 5 bits hexagonais de impacto 3/4"

Composição:

S05A6 Chaves: 14; 17; 19; 22 e 24mm de 88mm

S05A6H

Chave de impacto hexagonal de 3/4"

Ref.	Medida (mm)	Comprimento (mm)	Preço
			15.50€
S05A6H14	14	88	15.50€
S05A6H17	17	88	15.50€
S05A6H19	19	88	15.50€
S05A6H22	22	88	15.50€
S05A6H24	24	88	15.50€

S06A4T

Chaves de caixa com ponta macho torx de impacto de 1/2"

Ref.	Medida	Preço
		8.30€
S06A4T20	T20	8.30€
S06A4T27	T27	8.30€
S06A4T30	T30	8.30€
S06A4T40	T40	8.30€
S06A4T45	T45	8.30€
S06A4T50	T50	8.30€
S06A4T55	T55	8.30€
S06A4T60	T60	8.30€
S06A4T70	T70	8.60€
S06A4T80	T80	8.60€

S06A408S
50.00€

Jogo de 8 chaves de caixa com ponta macho torx de impacto 1/2"

Composição:

S06A4 Chaves: T30; T40; T45; T50; T55; T60; T70 e T80

S64A4106S
41.50€

Jogo de 6 chaves de impacto XZN de 1/2"

Composição:

S064A4 3 Chaves: M14; M16 e M18 de 45mm
3 Chaves: M14; M16 e M18 de 76mm

S64A61

Chave de impacto perfil XZN de 3/4"

Ref.	Medida	Comprimento (mm)	Preço
			12.00€
S64A6116	M16	61	12.00€
S64A6118	M18	61	12.30€

S64A6306S
71.00€

Jogo de 6 chaves de impacto XZN e Torx de 3/4"

Composição:

S064A6 4 Chaves Torx: T70; T80; T90 e T100 de 61mm
2 Chaves XZN: M16 e M18 de 61mm

S64A6T

Chave de impacto perfil Torx de 3/4"

Ref.	Medida	Comprimento (mm)	Preço
			11.50€
S64A6T70	T70	61	11.50€
S64A6T80	T80	61	11.70€
S64A6T90	T90	61	12.30€
S64A6T100	T100	61	12.80€

S12A4525S
220.00€

Jogo de 25 chaves impacto magnéticas de 1/2"

Composição:

Chaves de 1/2": 3/8"; 7/16"; 1/2"; 9/16"; 5/8"; 11/16"; 3/4"; 13/16"; 7/8"; 15/16" e 1"
Chaves de 1/2": 10 a 21mm
Cardan de 1/2"
Extensão 80mm



Ferramenta de aperto

S18A4117M 21.00€

Chave impacto magnética de 17 mm de 1/2"



S18A4119M 17.00€

Chave impacto magnética de 19 mm de 1/2"



S18A4121M 17.00€

Chave impacto magnética de 21 mm de 1/2"



S18A4103MS 65.00€

Jogo de 3 chaves impacto magnéticas de 1/2"

Composição:

Chaves: 17; 19 e 21mm



S18A41

Chave de impacto longa para rodas



Ref.	Quadra	Medida (mm)	D (mm)	L (mm)	Cor	Preço
S18A4115	1/2"	15	25	85	Laranja	7.00€
S18A4117	1/2"	17	27	85	Azul	9.60€
S18A4119	1/2"	19	28,5	85	Verde	10.00€
S18A4121	1/2"	21	31	85	Vermelho	10.50€

S18AD41

Chave de impacto extra longa para rodas



Ref.	Quadra	Medida (mm)	D (mm)	L (mm)	Cor	Preço
S18AD4117	1/2"	17	27	150	Azul	18.00€
S18AD4119	1/2"	19	28,5	150	Verde	18.00€
S18AD4121	1/2"	21	31	150	Vermelho	18.00€

S03AD4317 8.50€

Chave impacto de 17 mm de 1/2"



S03AD4319 8.50€

Chave impacto de 19 mm de 1/2"



S03AD4321 8.50€

Chave impacto de 21 mm de 1/2"



S03AD4303S 29.00€

Jogo de 3 chaves impacto de 1/2"

Composição:

Ref.	Medida (mm)
S03AD4317	17
S03AD4319	19
S03AD4321	21



S03AD4307S 76.50€

Jogo de 7 chaves impacto de 1/2"

Composição:

Ref.	Medida (mm)	Ref.	Medida (mm)
S03AD4317	17	S03AD4323	23
S03AD4319	19	S03AD4324	24
S03AD4321	21	S03AD4327	27
S03AD4322	22		



S03AD4503S 64.50€

Jogo de 3 chaves impacto longas de 1/2"

Composição:

Ref.	Medida (mm)	Compr. (mm)
S03AD4517	17	150
S03AD4519	19	150
S03AD4521	21	150



S03AD4517

18.50€

Chave impacto longa de 17 mm de 1/2"



S03AD4519

18.80€

Chave impacto longa de 19 mm de 1/2"



S03AD4521

19.00€

Chave impacto longa de 21 mm de 1/2"



S46TE80

15.00€

Barra de torque 110Nm de 1/2"

Comprimento: 196mm

Cor: azul



Alicates

com revestimento antideslizante

P018 18.00€

Alicate universal
Comprimento: 200mm



P038 14.50€

Alicate de corte diagonal
Comprimento: 200mm



P046 12.20€

Alicate de corte
Comprimento: 160mm



P068 14.40€

Alicate de pontas
Comprimento: 200mm
Capacidade máxima: Ø3,0mm



P068A 13.00€

Alicate de pontas
Comprimento: 200mm



P079 19.00€

Alicate universal
Comprimento: 220mm
Capacidade máxima: Ø3,0mm



P6008 9.20€

Alicate regulável (2 posições)
Comprimento: 200mm



P61

Alicate de corte frontal

Ref.	Compr. (mm)	Preço
P6106	160	11.20€
P6108	200	12.50€

P9506 15.90€

Alicate corta fios
Comprimento: 165mm
Peso: 188g



P27

Alicate ajustável

Ref.	Compr. (mm)	Preço
P2706	160	11.00€
P2710	250	14.50€
P2712	330	25.50€

P2810 16.80€

Alicate ajustável
Comprimento: 250mm



com mola

P266 10.50€

Alicate de freios internos e externos (pontas intermutáveis)

Capacidade: freios de 12 a 50mm
Pontas de: Ø1,2 e 1,5mm
Pontas direitas de: 45 e de 90°



AG010002S 49.00€

Jogo de 4 alicates de freios

Composição:

AG010002 Alicate de freios interiores com pontas direitas

AG010005 Alicate de freios interiores com pontas curvas

AG010008 Alicate de freios exteriores com pontas direitas

AG010011 Alicate de freios exteriores com pontas curvas



AG01000

Alicate de freios interiores (pontas direitas)

Ref.	Compr. (mm)	Preço
AG010002	175	10.50€
AG010003	230	15.50€



AG01000

Alicate de freios interiores (pontas curvas)

Ref.	Compr. (mm)	Preço
AG010005	175	10.70€
AG010006	230	15.50€



AG01000
Alicate de freios exteriores (pontas direitas)

Ref.	Compr. (mm)	Preço
AG010008	175	10.70€
AG010009	230	15.00€

AG01000
Alicate de freios exteriores (pontas curvas 90°)

Ref.	Compr. (mm)	Preço
AG010011	175	10.70€
AG010012	230	15.50€

P9508C
19.00€
Alicate de freios interiores (pontas curvas)

 Comprimento: 216mm
 Capacidade: 10-32mm

P9508D
19.00€
Alicate de freios exteriores (pontas curvas)

 Comprimento: 216mm
 Capacidade: 10-32mm

P9902S
260.00€
Jogo de 2 alicate de freios

 Composição:
 P9920A Alicate de freios internos
 P9920C Alicate de freios externos
 Capacidade: 165-300mm

P7101
19.60€
Mini alicate de pontas curvas 45° (desenho ergonómico)

 Comprimento: 140mm
 Peso: 90g

P7102
18.50€
Mini alicate de corte frontal (desenho ergonómico)

 Comprimento: 110mm
 Peso: 90g

Alicates
com revestimento antideslizante e mola
P7103
16.40€
Mini alicate de corte diagonal (desenho ergonómico)

 Comprimento: 115mm
 Peso: 90g

P7104
17.00€
Mini alicate universal (desenho ergonómico)

 Comprimento: 120mm
 Peso: 90g

P7105
17.00€
Mini alicate de pontas direitas (desenho ergonómico)

 Comprimento: 135mm
 Peso: 90g

P8006
19.50€
Alicate universal

Comprimento: 160mm

P8106
18.10€
Alicate pontas longas

Comprimento: 160mm

P8606
18.80€
Alicate de corte diagonal

Comprimento: 160mm

P9006
19.30€
Alicate pontas chatas

Comprimento: 160mm



Alicates

com revestimento antideslizante

Símbolo				
Tipo de material	Macio	Dureza média	Duro	Corda de piano
Exemplo	Cobre, alumínio	Ferro	Aço	Aço duro/ mola
Tensão N/mm ²	220-250	750-800	1700-1800	2200-2300

P051

Alicate corta cabos



Ref.	Compr. (mm)	mm ²	Ø mm	Preço
P0516	160	22	9.5	16.80€
P0518	200	38	11.5	19.30€

P0118

Alicate universal







Ref.	Compr. (mm)					Preço
P0118	200	5.0	3.5	2.4	2.0	18.00€

P081

Alicate universal







Ref.	Compr. (mm)					Preço
P0816	160	4.0	2.8	1.8	1.4	13.50€
P0817	180	4.0	3.0	2.0	1.6	14.70€
P0818	200	4.0	3.0	2.0	1.6	17.50€

P091

Alicate de corte (trabalho intensivo)







Ref.	Compr. (mm)					Preço
P0916	160	4.0	3.0	2.0	1.6	15.50€
P0917	180	5.0	3.5	2.4	2.0	16.80€
P0918	200	5.0	3.5	2.4	2.0	18.00€

P101

Alicate de corte



Ref.	Compr. (mm)					Preço
P1016	160	4.0	3.0	2.0	1.6	14.00€
P1017	180	4.0	3.0	2.0	1.6	15.60€

P111

Alicate de pontas







Ref.	Compr. (mm)					Preço
P1116	160	4.0	2.8	1.8	1.4	13.00€
P1118	200	4.0	3.0	2.0	1.6	15.50€

P121

Alicate de pontas curvas



Ref.	Compr. (mm)					Preço
P1216	160	4.0	2.8	1.8	1.4	14.00€
P1218	200	4.0	3.0	2.0	1.6	16.80€

P1416

Alicate de pontas chatas

Comprimento: 160mm



13.70€

P1516

Alicate de descarnar

Comprimento: 160mm



13.70€

P4016

Alicate de pontas redondas





Comprimento: 160mm



13.90€

P6116

Alicate de corte frontal

Ref.	Compr. (mm)					Preço
P6116	160	4.0	3.0	2.0	1.6	15.00€



P2811

Alicate ajustável

Ref.	Compr. (mm)	Preço
P28110	240	20.50€
P28112	300	29.00€



P2821
Alicate ajustável

Ref.	Compr. (mm)	Preço
P28210	240	26.00€
P28212	300	36.00€

P08104S
Jogo de 4 alicates

Composição:

P0817 Alicate universal

P0917 Alicate de corte diagonal

P1118 Alicate de pontas direitas

P28210 Alicate de ajustável

79.00€

PESD05
Alicate anti-estático pontas curvas (com mola)

Comprimento: 150mm

11.00€

PESD10
Alicate anti-estático de corte (com mola)

Comprimento: 115mm

10.30€

PESD11
Alicate anti-estático de pontas (com mola)

Comprimento: 130mm

10.50€

P178
Turquês de carpinteiro

Comprimento: 200mm

15.00€

P1810
Turquês de cofragens

Comprimento: 250mm

15.30€

Alicates
com revestimento antideslizante
P2010LA
12.80€
Tesoura articulada

Corte esquerda

Comprimento: 250mm

Peso: 395g

Capacidade de corte: Aço: 1,2mm | Aço inox: 0,7mm

P2010RA
13.30€
Tesoura articulada

Corte direita

Comprimento: 250mm

Peso: 395g

Capacidade de corte: Aço: 1,2mm | Aço inox: 0,7mm

P2010SA
13.30€
Tesoura articulada

Lâminas direitas

Comprimento: 200mm

P22
Tesoura de cortar chapa

Ref.	Compr. (mm)	Preço
P2208A	205	13.50€
P2212A	305	20.50€

P2205E
13.50€
Tesoura de electricista

P15808
14.50€
Tesoura multifunções

Lâminas em aço inox de 3mm

Comprimento: 206mm

P43
Alicate corta cabos

Ref.	Compr. (mm)	Peso	Capac. de corte	Preço
P4318	450	1 570g	fio 5mm cabo 10mm	43.00€
P4330	750	4 200g	fio 9mm cabo 14mm	82.00€



Alicates

P4318-RK 20.00€

Kit de reparação

P4330-RK 40.50€

Kit de reparação

P6424 42.30€

Alicate corta cabos

Comprimento: 600mm
Peso: 2 700g
Capacidade de corte: Ø 10mm



P7601 21.50€

Alicate longo de pontas direitas

Comprimento: 275mm



P7602 21.50€

Alicate longo de pontas curvas 45°

Comprimento: 275mm



P7603 21.50€

Alicate longo de pontas curvas 90°

Comprimento: 275mm



P7608 22.00€

Alicate longo de pontas redondas Ø13mm

Comprimento: 275mm



P7719 36.50€

Alicate longo de torcer arame

Comprimento: 270mm
Peso: 360g
Capacidade: Ø 0,55mm



V1001 18.00€

Alicate de rebitar (trabalho intensivo)

Inclui 4 bicos: 2,4; 3,2; 4 e 4,8mm



V1002 59.00€

Alicate de rebitar extensível

Inclui 4 bicos: 2,4; 3,2; 4 e 4,8mm



V1002-RK 2.10€

Kit de reparação para alicate de rebitar extensível V1002



V1003 47.00€

Alicate de rebitar (trabalho intensivo)

Inclui bicos: 6,4; 3,2; 4 e 4,8mm



V1003-RK 4.80€

Kit de reparação para alicate de rebitar V1003



V1005 21.00€

Alicate de rebitar (bicos intermutáveis)

Inclui bicos: 2,4; 3,2; 4 e 4,8mm



V21

Alicate de rebitar (bicos intermutáveis)

Ref. Bicos (mm) Preço

V2101 2,4; 3,2; 4 e 4,8 mm 32.50€

V2102 3,2; 4; 4,8 e 6,4 mm 47.50€



V2102-RK 5.20€

Kit de reparação para alicate de rebitar V2102



V1103 39.50€

Alicate de rebitar fêmeas

Capacidade: M3; M4; M5 e M6



V2401 66.50€

Alicate de rebitar fêmeas

Capacidade: M5; M6; M8 e M10



V2401
Mandril

Ref.	Medida	Preço
V2401-M5A	M5	3.40€
V2401-M6A	M6	3.40€
V2401-M8A	M8	3.40€
V2401-M10A	M10	3.40€

V2401
Bico

Ref.	Medida	Preço
V2401-M5B	M5	3.60€
V2401-M6B	M6	3.60€
V2401-M8B	M8	3.60€
V2401-M10B	M10	3.60€

AR030058
118.00€
Alicate de cravar terminais

Intermutável para 6 tipos de terminais

V1311
Alicate de cravar terminais

Ref.	Caraterísticas	Preço
V1311A	Terminais isolados	42.50€
V1311C	Fichas cabo coaxial	46.50€
V1311E	Terminais não isolados	42.00€
V1310F	Fichas RJ45	44.00€

V1310
Accessórios para alicate de cravar V1310

Ref.	Terminais	Preço
V1310A-11	Mordentes	14.50€
V1310B-11	Mordentes	14.50€
V1310E-11	Mordentes	15.00€
V1310F-11	Mordentes RJ45	20.20€
V1310G-11	Mordentes AWG 22-10 (0,5-10mm ²)	20.20€
V1310J-11	Mordentes AWG 10-60 (6-16mm ²)	20.20€

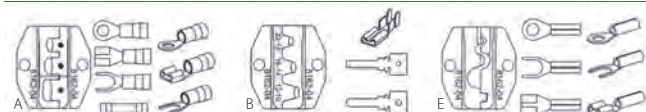
Alicates
V1401
10.10€
Alicate de cravar terminais/ descarnar fios

V1403
18.00€
Alicate de cravar (trabalho intensivo)

V1501
24.50€
Alicate de descarnar (trabalho intensivo)

Parafuso de ajuste à espessura do fio

Comprimento: 172mm

Peso: 305g

V1505
19.00€
Alicate de descarnar

P30M10A
13.80€
Alicate de pressão bicos direitos

Comprimento: 250mm

Peso: 540g

P32M
Alicate de pressão bocas côncavas

Ref.	Compr. (mm)	Preço
P32M07A	180	11.80€
P32M10A	250	13.00€

P36M09A
11.60€
Alicate de pressão bicos longos

Comprimento: 230mm

P36M
Alicate de pressão tipo pistola

Ref.	Compr. (mm)	Preço
P36M01P	28	27.50€
P36M02P	48	27.50€



P37M

Alicate de pressão pescoço de cisne

Ref.	Compr. (mm)	Preço
P37M11A	280	22.10€
P37M18A	450	39.00€



P38M

Alicate de pressão para soldadura

Ref.	Compr. (mm)	Preço
P38M09A	230	19.00€
P38M11A	280	23.50€

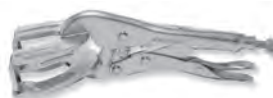

P52A10

Alicate de pressão boca direita ajustável

Comprimento: 250mm

42.00€



P52B10

Alicate de pressão boca curva ajustável

Comprimento: 250mm

37.00€



P52C10

Alicate de pressão boca curva ajustável

Comprimento: 250mm

47.00€



P52D12

Alicate de pressão boca longa ajustável

Comprimento: 300mm

44.00€



P52M10

Alicate de pressão bocas recurvadas

Comprimento: 250mm

17.00€



P53M

Alicate pescoço cisne maxilas oscilantes

Ref.	Compr. (mm)	Preço
P53M06	152	14.30€
P53M11	280	24.20€
P53M18	460	37.00€



P54M

Alicate de pressão para latoeiros

Ref.	Compr. (mm)	Preço
P54M08A	205	16.00€
P54M10A	250	19.70€



P52N10

Alicate de pressão boca larga

Comprimento: 240mm

22.00€



P1019

Alicate de pressão com corrente

Comprimento: 230mm
Capacidade: 457mm

19.00€



P9409

Alicate de pressão



16.70€



P30M07C

Alicate de pressão isolado

Comprimento: 175mm
Peso: 360g

14.20€



P32M

Alicate de pressão isolado com mordentes curvos e corta fios

Ref.	Compr. (mm)	Peso (g)	Preço
P32M05C	125	175	12.30€
P32M10C	250	560	15.50€





P36M

Alicate de pressão isolado bicos longos com corta fios

Ref.	Compr. (mm)	Peso (g)	Preço
P36M06C	152	180	12.50€
P36M09C	270	560	14.80€

P78M10C

17.30€

Alicate de pressão isolado
Comprimento: 250mm



P32M03S

44.50€

Jogo de 3 alicates de pressão

Ref.	Caraterísticas	Compr. (mm)
P36M06S	Bicos longos	160
P32M07S	Bocas côncavas	180
P32M10S	Bocas côncavas	250



Alicates

P7801

28.00€

Alicate de pressão multifunções
Garras tipo W



P7802

28.00€

Alicate de pressão multifunções
Garras tipo JJ



P7803

28.00€

Alicate de pressão multifunções
Garras tipo LL



P7804

27.00€

Alicate de pressão multifunções
Garras tipo J



P7805

27.00€

Alicate de pressão multifunções



D70S

Chaves fenda de impacto

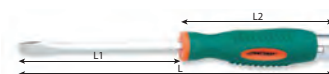

Ref.	Medida (mm)	L1 (mm)	L2 (mm)	L (mm)	Preço
D70S475	4	75	107	182	3.70€
D70S5100	5,5	100	107	207	4.80€
D70S6125	6,5	125	127	252	6.00€
D70S6150	6,5	150	127	277	6.30€
D70S8150	8	150	144	294	7.90€
D70S8175	8	175	144	319	8.00€
D70S9175	9,5	175	144	319	9.00€
D70S9250	9,5	250	144	394	9.80€

D70P

Chave phillips de impacto

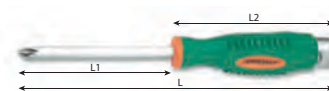

Ref.	Medida	L1 (mm)	L2 (mm)	L (mm)	Preço
D70P175	PH1	75	107	182	4.60€
D70P2100	PH2	100	127	277	5.50€
D70P3125	PH3	125	144	269	8.00€
D70P3150	PH3	150	144	299	8.30€

D70PP07S

48.00€

Jogo de 7 chaves fenda/ phillips de impacto

Composição/ medidas (mm):

3 Chaves fenda impacto: 5,5x100; 6,5x125 e 8x150

3 Chaves phillips: PH1x75; PH2x100 e PH3x125

1 Chave extensível com ponta magnética

D70PP10S

68.00€

Jogo de 10 chaves fenda/ phillips de impacto

Composição/ medidas (mm):

D70S Chaves fenda: 5,5x100; 6,5x125; 8x150; 9,5x175 e 6,5x38

D70P Chaves phillips: PH1x75; PH2x100; PH3x125 e PH2x38

Ponteiro magnético



DV14PP-TP

3.50€

Busca-polos

220 - 250 v

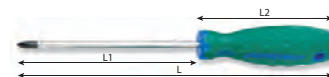

D71P
Chave phillips

Ref.	Medida	L1 (mm)	L2 (mm)	L (mm)	Preço
D71P060	PH0	60	90	150	2.70€
D71P138	PH1	38	56	94	2.60€
D71P180	PH1	80	110	190	3.00€
D71P238	PH2	38	56	94	2.60€
D71P1100	PH1	100	110	210	3.20€
D71P1150	PH1	150	110	250	3.50€
D71P1300	PH1	300	110	410	4.70€
D71P2100	PH2	100	119	219	3.60€
D71P2150	PH2	150	119	269	3.90€
D71P2250	PH2	250	119	369	6.00€
D71P2400	PH2	400	119	519	7.00€
D71P3150	PH3	150	129	279	5.40€
D71P3250	PH3	250	129	279	7.10€
D71P3400	PH3	400	129	529	9.20€
D71P4200	PH4	200	129	329	6.40€

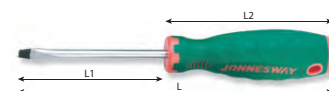
D71S
Chave fenda

Ref.	Medida (mm)	L1 (mm)	L2 (mm)	L (mm)	Preço
D71S250	2,4	50	72	122	2.30€
D71S360	3	60	72	132	2.50€
D71S4100	4	100	90	190	2.70€
D71S4150	4	150	110	260	3.40€
D71S4200	4	200	90	290	3.80€
D71S480	4	80	90	170	2.60€
D71S5125	5,5	125	110	235	3.10€
D71S5200	5,5	200	110	310	3.50€
D71S5300	5,5	300	110	410	4.70€
D71S538	5,5	38	56	94	2.50€
D71S575	5,5	75	110	185	3.00€
D71S638	6,5	38	56	94	2.50€
D71S6100	6,5	100	119	219	3.70€
D71S6150	6,5	150	119	269	3.80€
D71S6400	6,5	400	119	519	7.50€
D71S8150	8	150	129	279	5.20€
D71S8200	8	200	129	329	5.50€
D71S8300	8	300	129	429	7.40€
D71S8500	8	500	129	629	10.40€
D71S9175	9,5	175	129	304	5.70€
D71S10250	10	250			6.50€

D71T
Chave torx

Ref.	Medida	L1 (mm)	L2 (mm)	L (mm)	Preço
D71T5	T5	60	73	132	2.30€
D71T6	T6	60	73	132	2.30€
D71T7	T7	60	73	132	2.30€
D71T8	T8	60	73	132	2.40€
D71T9	T9	60	73	132	2.40€
D71T10	T10	80	90	170	2.50€
D71T15	T15	80	90	170	2.50€
D71T20	T20	100	110	210	3.00€
D71T25	T25	100	110	210	3.00€
D71T27	T27	100	119	219	4.00€
D71T30	T30	125	119	244	4.20€
D71T40	T40	150	129	279	5.30€
D71T45	T45	200	129	329	5.70€
D71T50	T50	200	129	329	6.30€

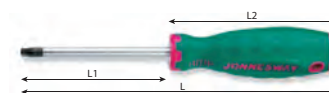
D71400T
Chave torx longa

Ref.	Medida	Compr. (mm)	Preço
D71400T10	T10	400	6.20€
D71400T15	T15	400	6.70€
D71400T20	T20	400	7.30€
D71400T25	T25	400	7.80€
D71400T27	T27	400	8.60€
D71400T30	T30	400	9.40€

D71Z
Chave pozi

Ref.	Medida	L1 (mm)	L2 (mm)	L (mm)	Preço
D71Z060	PZ0	60	90	150	2.60€
D71Z138	PZ1	38	56	94	2.60€
D71Z180	PZ1	80	110	190	2.90€
D71Z2100	PZ2	100	119	219	3.70€
D71Z3150	PZ3	150	129	279	5.20€
D71Z4200	PZ4	200	129	329	6.50€

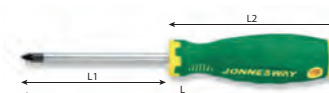
D725N
Chaves "T" de punho antideslizante com caixa sextavada

Ref.	Medida (mm)	Compr. (mm)	Preço
D725N06	6	298	6.20€
D725N07	7	298	6.20€
D725N08	8	298	6.20€
D725N09	9	298	6.30€
D725N10	10	298	6.30€
D725N11	11	298	6.40€
D725N12	12	298	6.60€
D725N13	13	298	6.60€



D715N

Chave caixa com punho



Ref.	Medida	L1 (mm)	L2 (mm)	L (mm)	Preço
D715N05	5	125	119	244	5.30€
D715N07	7	125	119	244	5.40€
D715N08	8	125	119	244	5.40€
D715N10	10	125	119	244	6.00€
D715N12	12	125	119	244	6.00€
D715N13	13	125	119	244	6.40€

D71C105S

18.00€

Jogo de 5 chaves fenda/ phillips

Composição/ medidas (mm):

Chaves fenda: 4x80; 5,5x125 e 6,5x150

Chaves phillips: PH1x80 e PH2x100

D71C106S

20.50€

Jogo de 6 chaves fenda/ phillips

Composição/ medidas (mm):

Chaves fenda: 3x60; 5,5x125 e 6,5x150

Chaves phillips: PH0x60; PH1x80 e PH2x100

D71PP08S

35.50€

Jogo de 8 chaves fenda/ phillips com punho antideslizante

Composição/ medidas (mm):

D71S Chaves fenda: 6,5x38; 4x80; 5,5x125 e 6,5x150

D71P Chaves phillips: PH2x38; PH1x80; PH2x100 e PH3x150

D71PP16S

77.50€

Jogo de 16 chaves fenda/ phillips com punho antideslizante

Composição/ medidas (mm):

D71S Chaves fenda: 6,5x38; 3x50; 6,5x100; 5,5x125; 5,5x200; 8,5x150; 5,5x75 e 4x150

D71P Chaves phillips: PH2x38; PH1x150; PH0x60; PH1x80; PH2x100; PH2x150; PH3x150 e PH1x38

D71T107S

27.00€

Jogo de 7 chaves torx com punho antideslizante

Composição/ medidas (mm):

Chaves: T10; T15; T20; T25; T27; T30 e T40

D71T109S

33.00€

Jogo de 9 chaves torx com punho antideslizante

Composição/ medidas (mm):

Chaves: T8; T9; T10; T15; T20; T25; T27; T30 e T40

D71Z105S

17.00€

Jogo de 5 chaves fenda/ pozi

Composição/ medidas (mm):

Chaves fenda: 4x80; 5,5x125 e 6,5x150

Chaves pozi: PZ1x80 e PZ2x100



D71Z107S

31.00€

Jogo de 7 chaves fenda/ pozi com punho antideslizante

Composição/ medidas (mm):

Chaves fenda: 4x100; 5,5x125; 6,5x150 e 8x175

Chaves pozi: PZ1x80; PZ2x100 e PZ3x150



D3750P08S

20.00€

Jogo de 8 chaves de precisão fenda/ phillips

Composição:

Ref.	Chave	Ponta (mm)	Compr. (mm)
D3750S30	fenda	3	50
D3750S24	fenda	2,4	50
D3750S20	fenda	2	50
D3750S16	fenda	1,6	50
D3750S10	fenda	1	50
D3750P1	phillips	nº1	50
D3750P0	phillips	nº0	50
D3750P00	phillips	nº00	50



D3750T08S

19.20€

Jogo de 8 chaves de precisão torx

Composição:

Ref.	Medida (mm)	Ref.	Medida (mm)
D3750T20	T20x50	D3750T8	T8x50
D3750T15	T15x50	D3750T7	T7x50
D3750T10	T10x50	D3750T6	T6x50
D3750T9	T9x50	D3750T5	T5x50



D3750P

Chave de precisão phillips

Ref.	Medida (mm)	Preço
D3750P0	PH0x50	1.95€
D3750P00	PH00x50	1.95€
D3750P1	PH1x50	1.95€



D3750S

Chave de precisão fenda

Ref.	Medida (mm)	Preço
D3750S10	1x50	2.00€
D3750S16	1,6x50	2.00€
D3750S20	2x50	2.00€
D3750S24	2,4x50	2.00€
D3750S30	3x50	2.00€



D3750T

Chave de precisão torx

Ref.	Medida (mm)	Preço
D3750T5	T5x50	2.00€
D3750T6	T6x50	2.00€
D3750T7	T7x50	2.00€
D3750T8	T8x50	2.00€
D3750T9	T9x50	2.00€
D3750T10	T10x50	2.00€
D3750T15	T15x50	2.00€
D3750T20	T20x50	2.00€



D3750T18S

18.00€

Jogo de 8 chaves de precisão

Composição:

Ref.	Medida (mm)	Ref.	Medida (mm)
D3750P00	P00x50	D3750T7	T7x50
D3750T4	T4x50	D3750A1	garfo 50
D3750T5	T5x50	D3750A2	inclinação 50
D3750T6	T6x50	D3750A3	agulha 50



DR0253S

54.00€

Jogo de bits e porta bits flexível

Composição/ medidas (mm):

- Porta bits flexível
- Bits phillips: #1; #2 e #3
- Bits fenda: 3; 4; 5,5; e 7
- Bits pozi: #0; #1; #2; e #3
- Bits hexagonal: 2; 2,5; 3; 4; 5 e 6
- Bits torx tamper proof: T8; T10; T15; T20; T25; T27; T20 e T40
- Bits torx: T6; T8; T9; T10; T15; T20; T25; T27; T30 e T40
- Adaptador 1/4" hexagonal
- Adaptador magnético



DR0107S

14.70€

Jogo de bits longos e porta bits

Composição/ medidas (mm):

- Porta bits
- Bits duplo 65mm
- Pozi 1/ fenda 5mm
- Pozi 2/ fenda 6mm
- Pozi 3/ fenda 7mm
- Hexagonal 3mm/ 4mm
- Hexagonal 5mm/ 6mm
- Phillips/ fenda 6mm



DR04

8.20€

Punho de 1/4" com roquete reversível

Comprimento total: 157mm



DBT31B

17.00€

Jogo de porta pontas de punho

Composição/ medidas (mm):

- Porta pontas de punho
- Pontas phillips
- Pontas fenda
- Pontas pozi
- Pontas hexagonais
- Pontas torx



DBT53A

57.00€

Jogo de 54 bits de 1/4" (cores)

Composição/ medidas (mm):

- Porta bits 1/4" 60mm
- 5x Bits pozi (azul) de 25mm
- 4x Bits pozi (azul) de 75mm
- 5x Bits fenda (laranja) 25mm
- 2x Bits fenda (laranja) 75mm
- 11x Bits torx (amarelo) 25mm
- 11x Bits torx (amarelo) 75mm
- 5x Bits phillips (vermelho) de 25mm
- 4x Bits phillips (vermelho) de 75mm
- 4x Bits hexagonais (laranja claro) 25mm
- 3x Bits hexagonais (laranja claro) 75mm



RD0638S

47.50€

Jogo de roquete com bits 1/4" com 38 peças

Composição:

- R3702 Roquete 48 dentes de 1/4"
- S04H2 10 Chaves de caixa 1/4" de 5; 6; 7; 8; 9; 10; 11; 12; 13 e 14mm
- D125FC 3 Bits fenda 4; 5 e 6mm (25mm laranja)
- D125PC 4 Bits phillips PH1, PH2 x2 e PH3 (25mm vermelho)
- D125ZC 3 Bits pozi PZ1, PZ2 e PZ3 (25mm azul)
- D125HC 5 Bits hexagonal 3; 4; 5; 6 e 8mm (25mm laranja claro)
- D125TC 7 Bits torx T10, T15, T20, T25, T27, T30 e T40 (25mm amarelo)
- S44H2306 Porta bits hexagonal de 1/4"
- S24H250 Extensão de 1/4" de 50mm
- S24H2100 Extensão de 1/4" de 100mm
- S26H2150A Punho de 1/4"
- S15H240 Cardan de 1/4"



RD01032S

35.80€

Jogo roquete com bits 1/4" com 32 peças

Composição:

- Roquete 1/4" de 60 dentes
- Porta bits magnético
- Bits phillips
- Bits hexagonais
- Bits quadrados
- Bits pozi
- Bits torx
- Bits fenda
- Bits torx tamperproof



S08H208S

7.00€

Jogo de porta pontas angular (90°)

Composição:

- 7 Pontas 1/4"





S14A4

Chave para retirar fêmeas danificadas 1/2"

Ref.	Medida (mm)	Comp. (mm)	Preço
S14A4117	17		12.00€
S14A4118	18,5		12.00€
S14A4120	20	25	12.10€
S14A4121	21,5		12.10€
S14A4123	23	30	13.00€
S14A4124	24,5	30	13.00€
S14A4126	26	30	13.10€
S14A4127	27,5	33	13.30€



S14A4108S

97.00€

Jogo de 8 chaves para retirar fêmeas danificadas 1/2"

Composição/ medidas (mm):

Chaves: 17; 18,5; 20; 21,5; 23; 24,5; 26 e 27,5



RD05H2

15.00€

Chave de mão para bits

Quadra: 1/4"



S29H2133S

12.30€

Jogo de porta bits 1/4" com 33 peças

Composição:

- Porta bits magnético
- Bits torx
- Bits torx tamperproof
- Bits perfil "Tri Wing"
- Bits perfil "Spanner"
- Bits hexagonais



S29TP23S

31.00€

Jogo de bits Torx Plus de 1/4" com 23 peças

Composição:

- 5 Bits torx plus tamperproof de 1/4": TS10H; TS15H; TS20H; TS25H e TS30H
- 5 Bits torx plus tamperproof de 10mm: TS40H; TS45H; TS50H; TS55H e TS60H
- 5 Bits torx plus de 1/4": IP10H; IP15H; IP20H; IP25H e IP30H
- 5 Bits torx plus de 10mm: IP40H; IP45H; IP50H; IP55H e IP60H
- 1 Adaptador 3/8" x 10mm:
- 1 Adaptador 1/4" x 1/4"
- 1 Porta bits 1/4" x 1/4" com 60mm comprimento





D125H

Pontas/ bits de 1/4" hexagonais

Ref.	Medida (mm)	Compr. (mm)	Preço
D125H015A	1,5	25	0.35€
D125H020A	2	25	0.35€
D125H025A	2,5	25	0.35€
D125H030A	3	25	0.35€
D125H040A	4	25	0.35€
D125H050A	5	25	0.35€
D125H060A	6	25	0.35€
D125H070A	7	25	0.55€



D125T

Pontas/ bits de 1/4" torx

Ref.	Medida (mm)	Compr. (mm)	Preço
D125T06B	T6	25	0.30€
D125T08B	T8	25	0.30€
D125T10A	T10	25	0.35€
D125T15A	T15	25	0.35€
D125T20A	T20	25	0.35€
D125T25A	T25	25	0.35€
D125T27A	T27	25	0.35€
D125T30A	T30	25	0.35€
D125T40A	T40	25	0.35€



D125F

Pontas/ bits de 1/4" fenda

Ref.	Medida (mm)	Compr. (mm)	Preço
D125F4506A	0,6x4,5	25	0.35€
D125F6512A	1,2x6,5	25	0.35€
D125F8016A	1,6x8	25	0.55€



D125P

Pontas/ bits de 1/4" phillips

Ref.	Medida (mm)	Compr. (mm)	Preço
D125P1F	PH1	25	0.35€
D125P2F	PH2	25	0.35€
D125P3F	PH3	25	0.35€



D125Z

Pontas/ bits de 1/4" pozi

Ref.	Medida (mm)	Compr. (mm)	Preço
D125Z1A	PZ1	25	0.35€
D125Z2A	PZ2	25	0.35€
D125Z3A	PZ3	25	0.35€

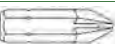

Chaves

as pontas bits são vendidas em embalagens de 10 unidades
os preços indicados são por unidade



D130H

Pontas/ bits de 10mm hexagonais

Ref.	Medida (mm)	Compr. (mm)	Preço
D130H40	4	30	0.90€
D130H50	5	30	0.90€
D130H60	6	30	0.90€
D130H70	7	30	0.90€
D130H80	8	30	0.90€
D130H100	10	30	0.95€
D130H120	12	30	1.10€



D130T

Pontas/ bits de 10mm torx

Ref.	Medida (mm)	Compr. (mm)	Preço
D130T20	T20	30	0.85€
D130T25	T25	30	0.90€
D130T30	T30	30	0.90€
D130T40	T40	30	0.90€
D130T45	T45	30	0.90€
D130T50	T50	30	0.95€
D130T55	T55	30	0.95€



D150F

Pontas/ bits de 1/4" fenda

Ref.	Medida (mm)	Compr. (mm)	Preço
D150F5510A	1x5,5	50	0.55€
D150F6512A	1,2x6,5	50	0.55€
D150F8012A	1,2x8	50	0.70€

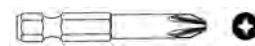

D150P

Pontas/ bits de 1/4" phillips

Ref.	Medida (mm)	Compr. (mm)	Preço
D150P1A	PH1	50	0.55€
D150P2A	PH2	50	0.55€
D150P3A	PH3	50	0.55€



D150Z

Pontas/ bits de 1/4" pozi

Ref.	Medida (mm)	Compr. (mm)	Preço
D150Z1A	PZ1	50	0.55€
D150Z2A	PZ2	50	0.55€
D150Z3A	PZ3	50	0.55€

D150H



Pontas/ bits de 1/4" hexagonais

Ref.	Medida (mm)	Compr. (mm)	Preço
D150H030A	3	50	0.55€
D150H040B	4	50	0.55€
D150H050A	5	50	0.55€
D150H060B	6	50	0.55€
D150H070B	7	50	0.65€
D150H080B	8	50	0.70€

D150T



Pontas/ bits de 1/4" torx

Ref.	Medida (mm)	Compr. (mm)	Preço
D150T20A	T20	50	0.55€
D150T25A	T25	50	0.55€
D150T27A	T27	50	0.55€
D150T30A	T30	50	0.55€
D150T40A	T40	50	0.55€

D100MN



Ponta hexagonal magnética de 1/4" para fêmeas

Ref.	Medida (mm)	Compr. (mm)	Preço
D100MN08M	8	100	3.20€
D100MN10M	10	100	3.90€
D100MN12M	12	100	4.10€
D100MN13M	13	100	4.10€
D100MN14M	14	100	4.30€

D10M3



Pontas/ bits de 10mm estriado XZN

Ref.	Medida (mm)	Compr. (mm)	Preço
D10M30M05A	M5	30	0.90€
D10M30M06A	M6	30	0.90€
D10M30M08A	M8	30	0.90€
D10M30M10A	M10	30	0.90€
D10M30M12A	M12	30	1.10€
D10M30M14A	M14	30	1.20€

D10M7



Pontas/ bits de 10mm estriado XZN

Ref.	Medida (mm)	Compr. (mm)	Preço
D10M75M05A	M5	75	1.40€
D10M75M06A	M6	75	1.50€
D10M75M08A	M8	75	1.50€
D10M75M10A	M10	75	1.50€
D10M75M12A	M12	75	1.80€
D10M75M14A	M14	75	2.00€

D175H



Pontas/ bits de 10mm hexagonais

Ref.	Medida (mm)	Compr. (mm)	Preço
D175H40	4	75	1.50€
D175H50	5	75	1.50€
D175H60	6	75	1.50€
D175H70	7	75	1.50€
D175H80	8	75	1.50€
D175H100	10	75	1.60€
D175H120	12	75	1.90€

D175T



Pontas/ bits de 10mm torx longo

Ref.	Medida (mm)	Compr. (mm)	Preço
D175T20	T20	75	1.50€
D175T25	T25	75	1.50€
D175T30	T30	75	1.50€
D175T40	T40	75	1.50€
D175T45	T45	75	1.50€
D175T50	T50	75	1.50€
D175T55	T55	75	1.50€

D125TT



Pontas/ bits de 1/4" torx tamper proof

Ref.	Medida (mm)	Compr. (mm)	Preço
D125TT08B	T8	25	0.40€
D125TT10B	T10	25	0.40€
D125TT15B	T15	25	0.40€
D125TT20B	T20	25	0.40€
D125TT25B	T25	25	0.40€
D125TT27B	T27	25	0.40€
D125TT30B	T30	25	0.40€
D125TT35B	T35	25	0.40€
D125TT40B	T40	25	0.40€

D150MH

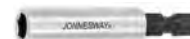

Porta pontas/ bits magnético para bits de 1/4"

Ref.	Medida (mm)	Compr. (mm)	Preço
D150MH1AD	10	50	2.10€

D150MH



Porta pontas/ bits magnético de encaixe rápido

Ref.	Medida (mm)	Compr. (mm)	Preço
D150MH1QD	10,5	50	5.00€

D165MN



Ponta hexagonal magnética de 1/4" para fêmeas

Ref.	Medida (mm)	Compr. (mm)	Preço
D165MN06M	6	65	2.20€
D165MN07M	7	65	2.20€
D165MN08M	8	65	2.20€
D165MN10M	10	65	2.70€
D165MN12M	12	65	3.50€
D165MN13M	13	65	3.50€

S29H2180S

38.00€

Conjunto de 180 pontas

Composição:

- phillips
- pozi
- hexagonais
- torx



H01SA



Chaves hexagonais curtas antideslizante

Ref.	Medida (mm)	L1 (mm)	L2 (mm)	Preço
H01SA115	1,5	46,5	15,5	0.45€
H01SA120	2	52	18	0.45€
H01SA125	2,5	58,5	20,5	0.45€
H01SA130	3	66	23	0.70€
H01SA140	4	74	29	0.95€
H01SA150	5	85	33	1.15€
H01SA160	6	96	38	1.60€
H01SA180	8	108	44	1.65€
H01SA1100	10	122	50	2.75€

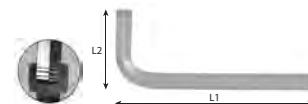

H01MH118S



43.00€

Jogo de 18 chaves hexagonais curtas

Composição/ medidas (mm):

- Chaves: 1,5; 2; 2,5; 3; 3,5; 4; 4,5; 5; 5,5; 6; 7; 8; 9; 10; 12; 14; 17 e 19



H01SA109S



11.50€

Jogo de 9 chaves hexagonais curtas

Sistema especial antideslizante

Composição/ medidas (mm):

- Chaves: 1,5; 2; 2,5; 3; 4; 5; 6; 8 e 10



H01SM109S



11.50€

Jogo de 9 chaves hexagonais curtas

Composição/ medidas (mm):

- Chaves: 1,5; 2; 2,5; 3; 4; 5; 6; 8 e 10



H02MH217S



59.90€

Jogo de 17 chaves hexagonais longas SAE

Composição/ medidas:

- Chaves: 1/16"; 5/64"; 3/32"; 7/64"; 1/8"; 9/64"; 5/32"; 3/16"; 1/4"; 5/16"; 3/8"; 7/16"; 1/2"; 9/16"; 5/8" e 3/4"



H01B



Chave hexagonal curta



Ref.	Medida (mm)	Preço
H01B1015	1,5	0.10€
H01B1020	2	0.12€
H01B1025	2,5	0.15€
H01B1030	3	0.20€
H01B1035	3,5	0.40€
H01B1040	4	0.50€
H01B1045	4,5	0.60€
H01B1050	5	0.65€
H01B1055	5,5	0.75€
H01B1060	6	0.75€
H01B1070	7	1.00€
H01B1080	8	1.15€
H01B1090	9	1.65€
H01B1100	10	1.90€
H01B1120	12	3.60€
H01B1140	14	5.00€
H01B1160	16	6.80€
H01B1170	17	7.50€
H01B1180	18	9.50€
H01B1190	19	10.90€
H01B1220	22	15.80€



H02SM109S 14.20€

Jogo de 9 chaves hexagonais longas

Composição/ medidas (mm):

 Chaves: 1,5; 2; 2,5; 3; 4;
5; 6; 8 e 10

H02SM209S 14.00€

Jogo de 9 chaves hexagonais longas SAE

Composição/ medidas:

 Chaves: 1/16"; 5/64";
3/32"; 1/8"; 5/32";
3/16"; 1/4"; 5/16" e 3/8"

H03MH118S 68.00€

Jogo de 18 chaves hexagonais extra longas

Composição/ medidas (mm):

 Chaves: 1,5; 2; 2,5; 3; 3,5; 4;
4,5; 5; 5,5; 6; 7; 8; 9;
10; 12; 14; 17 e 19

H03SM109S 16.00€

Jogo de 9 chaves hexagonais extra longas

Composição/ medidas (mm):

 Chaves: 1,5; 2; 2,5;
3; 4; 5; 6; 8 e 10

H06SA

Chaves hexagonais extra longas com ponta esférica antideslizante

Ref.	Medida	L1 (mm)	L2 (mm)	Preço
H06SA115	1,5	91,5	15,5	0.65€
H06SA120	2	102	18	0.65€
H06SA125	2,5	114,5	20,5	0.65€
H06SA130	3	129	23	0.90€
H06SA140	4	144	29	1.20€
H06SA150	5	165	33	1.40€
H06SA160	6	186	38	2.10€
H06SM170	7			2.50€
H06SA180	8	208	44	2.65€
H06SA1100	10	234	50	3.65€

H06SM209S 17.90€

Jogo de 9 chaves hexagonais com ponta esférica SAE

Composição/ medidas (mm):

 Chaves: 1/16"; 5/64";
3/32"; 1/8"; 5/32"; 3/16";
1/4"; 5/16" e 3/8"

H03SS109S 19.00€

Jogo de 9 chaves macho hexagonais de baixo perfil

Composição/ medidas (mm):

 Chaves: 1,5; 2; 2,5;
3; 4; 5; 6; 8 e 10

H05SS109S 18.50€

Jogo de 9 chaves macho hexagonais com ponta esférica de baixo perfil

Composição/ medidas (mm):

 Chaves: 1,5; 2; 2,5; 3;
4; 5; 6; 8 e 10 mm

H05SA109S 15.30€

Jogo de 9 chaves hexagonais longas com ponta esférica antideslizante

Composição/ medidas (mm):

 Chaves: 1,5; 2; 2,5; 3;
4; 5; 6; 8 e 10

H06MT109S 18.00€

Conjunto de 9 chaves hexagonais longas com ponta esférica

Composição/ medidas (mm):

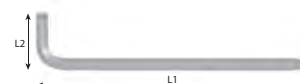
 Chaves: 1,5; 2; 2,5; 3;
4; 5; 6; 8 e 10 mm

Preço

Ref.	Medida	L1 (mm)	L2 (mm)	Preço
H06SA115	1,5	91,5	15,5	0.65€
H06SA120	2	102	18	0.65€
H06SA125	2,5	114,5	20,5	0.65€
H06SA130	3	129	23	0.90€
H06SA140	4	144	29	1.20€
H06SA150	5	165	33	1.40€
H06SA160	6	186	38	2.10€
H06SM170	7			2.50€
H06SA180	8	208	44	2.65€
H06SA1100	10	234	50	3.65€

H06SA109S 16.50€

Jogo de 9 chaves hexagonais macho extra longas com ponta esférica antideslizante

H06SM209S 17.90€

Jogo de 9 chaves hexagonais com ponta esférica SAE

Composição/ medidas (mm):

 Chaves: 1/16"; 5/64";
3/32"; 1/8"; 5/32"; 3/16";
1/4"; 5/16" e 3/8"

H06SM

Chave hexagonal longa de ponta esférica SAE

Ref.	Medida	Preço
H06SM225	3/32"	0.85€
H06SM230	1/8"	0.95€
H06SM240	5/32"	1.25€
H06SM250	3/16"	1.65€
H06SM255	7/32"	1.75€
H06SM260	1/4"	1.85€
H06SM280	5/16"	2.90€
H06SM2100	3/8"	4.00€

H06W106S

66.00€

Jogo de 6 chaves articuladas hexagonais de ponta redonda

Composição/ medidas (mm):

Chaves: 3; 4; 5; 6; 8 e 10

H07M09S

12.50€

Jogo de 9 chaves torx

Composição/ medidas (mm):

Chaves: T10; T15; T20; T25; T27; T30; T40; T45 e T50

H07MT

Chave torx em L

Ref.	Medida	Preço
H07MT10	T10	0.90€
H07MT15	T15	1.00€
H07MT20	T20	1.10€
H07MT25	T25	1.15€
H07MT27	T27	1.30€
H07MT30	T30	1.35€
H07MT40	T40	1.60€
H07MT45	T45	1.90€
H07MT50	T50	2.45€

H0816S

25.00€

Jogo de 16 chaves macho com ponta torx

Composição/ medidas (mm):

Chaves: T6; T7; T8; T9; T10; T15; T20; T25; T27; T30; T40; T45; T50; T55; T60 e T70

H08MTP09S

15.00€

Jogo de 9 chaves torx tamperproof

Composição/ medidas (mm):

Chaves: T10; T15; T20; T25; T27; T30; T40; T45 e T50

H08S110S

23.50€

Jogo de 10 chaves torx longas tamperproof

Composição/ medidas (mm):

Chaves: T9; T10; T15; T20; T25; T27; T30; T40; T45 e T50

Chaves
H08ST

Chaves torx longas tamperproof

Ref.	Medida	Compr. (mm)	Preço
H08ST09085	T9	80	1.50€
H08ST10090	T10	90	1.50€
H08ST15100	T15	100	1.60€
H08ST20115	T20	112	1.70€
H08ST25130	T25	126	1.70€
H08ST27145	T27	142	1.80€
H08ST30165	T30	160	2.20€
H08ST40185	T40	180	2.50€
H08ST45205	T45	200	3.10€
H08ST50230	T50	224	3.90€

H10MB08S

36.50€

Jogo de 8 chaves hexagonais duplas de punho

Composição/ medidas (mm):

Chaves: 2x100; 2,5x100; 3x100; 4x100; 5x150; 6x150; 8x200 e 10x200

H10MB

Chave hexagonal dupla de punho com ponta esférica

Ref.	Medida	Preço
H10MB2100	2x100	3.00€
H10MB25100	2,5x100	3.00€
H10MB3100	3x100	3.10€
H10MB4100	4x100	3.20€
H10MB5150	5x150	3.40€
H10MB6150	6x150	3.70€
H10MB8200	8x200	5.60€
H10MB10200	10x200	7.50€

H10MT09S

44.00€

Jogo de 9 chaves duplas torx tamperproof com punho

Composição/ medidas (mm):

Chaves: T10x100; T15x100; T20x100; T25x100; T27x150; T30x150; T40x150; T45x200 e T50x200



Chaves

H10MT



Chave dupla de punho torx tamperproof

Ref.	Medida	Preço
H10MT10100	T10x100	2.80€
H10MT15100	T15x100	3.30€
H10MT20100	T20x100	3.30€
H10MT25100	T25x100	3.40€
H10MT27150	T27x150	3.40€
H10MT30150	T30x150	3.80€
H10MT40150	T40x150	4.20€
H10MT45200	T45x200	6.30€
H10MT50200	T50x200	6.70€

H12S110S

22.50€

Jogo de 10 chaves torx longas

Composição/ medidas (mm):
Chaves: T9; T10;
T15; T20; T25; T27;
T30; T40; T45 e T50



H15M105S

17.70€

Jogo de 5 chaves estriadas em "L"

Composição/ medidas (mm):
Chaves: M5; M6; M8; M10 e M12



H12S

Chaves torx extra longa

Ref.	Medida	L1 (mm)	L2 (mm)	Preço
H12S09085	T9	85	5	1.30€
H12S10090	T10	90	5,5	1.30€
H12S15100	T15	100	8	1.35€
H12S20115	T20	115	12,5	1.50€
H12S25130	T25	130	18	1.55€
H12S27145	T27	145	24,5	1.75€
H12S30165	T30	165	40	2.10€
H12S40185	T40	185	62	2.50€
H12S45205	T45	205	98	2.90€
H12S50230	T50	230	128	4.00€



H20MT

Chaves torx dupla de punho

Ref.	Medida	L1 (mm)	L2 (mm)	Preço
H20MT10	T10	110	15	3.20€
H20MT15	T15	120	15	3.30€
H20MT20	T20	125	16	3.90€
H20MT25	T25	135	16	4.00€
H20MT27	T27	145	16	4.20€
H20MT30	T30	155	16	4.60€
H20MT40	T40	165	16	5.30€
H20MT45	T45	185	16	6.00€
H20MT50	T50	205	20	7.20€



H20MB1037S



64.00€

Jogo de 9 chaves hexagonais de ponta esférica com punho e 28 bits

Composição/ medidas (mm):

H20MB Chaves: H1,5X100; H2X100; H2,5X110; H3X120; H4X125; H5X155; H6X165; H8X185 e H10X210
 Bits phillips: PH1; PH2 e PH3
 Bits pozi: PZ1; PZ2 e PZ3
 Bits torx: T10; T15; T20; T25; T27; T30; T35 e T40
 Bits fenda: 3; 4; 5; 6 e 7
 Bits estriados: M4; M5 e M6
 Bits quadrados: 1; 2 e 3
 Bits spanner: 4 e 6



H20MT09S



61.00€

Jogo de 9 chaves torx duplas de punho

Composição/ medidas (mm):

Chaves: T10x110; T15x120; T20x125; T25x135; T27x145; T30x155; T40x165; T45x185 e T50x205



H22S109S



21.50€

Jogo de 9 chaves hexagonais extra longas estriadas
 Especial para remover parafusos danificados

Composição/ medidas (mm):

Chaves: 1,5; 2; 2,5; 3; 4; 5; 6; 8 e 10

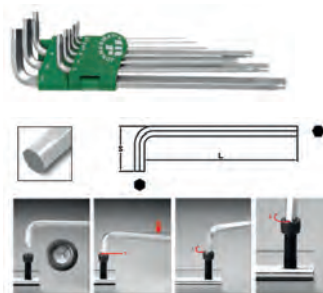

JR72

TOYOTA CAETANO
 MOTORSPORT

Martelos

M03025

29.50€

Marreta metálica

Peso: 1 330g



M040

Martelo com batente redondo e pena esférica

Ref.	Peso (g)	Compr. (mm)	Preço
M04008	395	278	12.50€
M04012	527	283	13.50€
M04016	780	327	15.50€
M04024	1 063	383	21.00€
M04032	1 208	385	22.50€



M010

Martelo de orelhas em aço

Ref.	Peso (g)	Compr. (mm)	Preço
M01016	777	320	29.00€
M01020	875	350	31.50€



M05020

18.50€

Martelo de orelhas

Peso: 830g

Comprimento: 330mm



M060

Marreta

Ref.	Peso (g)	Compr. (mm)	Preço
M06030	1 550	263	21.00€
M06040	2 250	276	24.00€



M07016

19.00€

Martelo de batentes plásticos

Peso: 840g

Comprimento: 314mm



M07016-ACE

3.00€

Batente amarelo de substituição M07016



M07016-TPR

1.80€

Batente preto de substituição M07016



JONNESWAY

M29

Martelo de batentes plásticos intermutáveis

Ref.	Diâmetro (mm)	Compr. (mm)	Preço
M2927	27	270	21.00€
M2932	32	290	24.50€



M2927

Batentes para martelo M2927

Ref.	Cor	Preço
M2927-T1	branco	2.60€
M2927-T2	amarelo	3.90€



M2932

Batentes para martelo M2932

Ref.	Cor	Preço
M2932-T1	branco	3.10€
M2932-T2	amarelo	3.60€



M2940

Batentes para martelo M2940

Ref.	Cor	Preço
M2940-T1	branco	4.30€
M2940-T2	amarelo	6.50€



M2950

Batentes para martelo M2950

Ref.	Cor	Preço
M2950-T1	branco	5.90€
M2950-T2	amarelo	8.80€



M09

Martelo de mecânico tipo "alemão"

Ref.	Peso (g)	Compr. (mm)	Preço
M09100	100	260	8.50€
M09200	200	280	9.50€
M09300	300	300	11.30€
M09500	500	320	14.00€
M09800	800	350	18.00€
M091000	1 000	360	22.80€



M110

Martelo anti recuo revestido a borracha

Ref.	Peso (g)	Compr. (mm)	Preço
M11035	400	260	16.30€
M11045	520	286	19.50€
M11065	1500	370	33.50€



M601
Punção de bico

Ref.	D (mm)	D1 (mm)	L (mm)	Preço
M60103	3	9,5	120	1.90€
M60104	4	9,5	120	2.30€
M60105	5	12	120	3.00€

M611
Talhadeira

Ref.	D (mm)	D1 (mm)	L (mm)	Preço
M61110	10	9,5	150	2.65€
M61112	12	9,5	130	2.70€
M61113	13	9,5	150	2.75€
M61116	16	12,7	180	3.80€
M61119	19	15,8	180	5.30€
M61122	22	15,8	200	6.00€
M61125	25	19	200	8.50€

M621
Punção

Ref.	D (mm)	D1 (mm)	L (mm)	Preço
M62102	2	9,5	120	2.10€
M62103	3	9,5	120	2.10€
M62104	4	9,5	120	2.10€
M62105	5	9,5	120	2.10€
M62106	6	9,5	120	2.10€
M62108	8	9,5	120	2.15€

M631
Saca troços

Ref.	D (mm)	D1 (mm)	L (mm)	Preço
M63102	2	8	115	2.30€
M63103	3	8	125	2.40€
M63104	4	9,5	150	2.80€
M63105	5	9,5	165	3.10€
M63106	6	12,7	180	3.60€
M63108	8	12,7	180	3.70€

M641
Buril

Ref.	D (mm)	D1 (mm)	L (mm)	Preço
M64105	5	9,5	130	3.40€

M63106S

18.50€

Jogo de 6 saca troços

Composição/ medidas (mm):

- 2x8x115; 3x8x125;
- 4x9,5x150; 5x9,5x165;
- 6x12,7x180 e 8x12,7x180



M63M106S

20.00€

Jogo de 6 saca troços cromados

Composição/ medidas (mm):

- 2x8x115; 3x8x125; 4x9,5x150;
- 5x9,5x165; 6x12,7x180 e 8x12,7x180

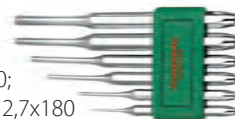

M64105S

13.50€

Jogo de 5 punções e escopros

Composição/ medidas (mm):

- Punção: 2x8x115; 3x8x125;
- 4x9,5x150; 5x9,5x165; 6x12,7x180
- Escopro: 8x12,7x180



M64M105S

14.80€

Jogo de 5 punções e escopros cromados

Composição/ medidas (mm):

- Punção: 3x 9,5x120
- Punção bico: 2x9,5x120
- Talhadeira: 12x9,5x130
- Saca troços: 4x9,5x150
- Escopro: 5x9,5x130



M61H1

Escopro com punho de proteção



Ref.	Medida (mm)	Compr. (mm)	Preço
M61H116	16	170	5.80€
M61H119	19	190	7.00€
M61H124	24	220	10.50€

M62H1

Punção com punho de proteção



Ref.	Medida (mm)	Compr. (mm)	Preço
M62H102	2	185	4.90€
M62H103	3	185	4.90€
M62H104	4	185	4.90€
M62H106	6	185	4.90€

M63H1

Saca troços com punho de proteção



Ref.	Medida (mm)	Compr. (mm)	Preço
M63H103	3	150	3.90€
M63H105	5	200	5.10€
M63H106	6	210	6.40€
M63H108	8	220	7.00€

A1030045

112.00€

Jogo de 4 cinzéis com proteção



MF05

Limas

Ref.	Tipo	Medida (mm)	Preço
MF05A	chata	200	8.70€
MF05B	redonda	200	7.50€
MF05C	meia cana	200	9.00€
MF05D	quadrada	200	8.70€
MF05E	triangular	200	8.30€

MF05S

50.00€

Jogo de 5 limas de 200mm

Composição:

- MF05A Lima chata
- MF05B Lima redonda
- MF05C Lima meia cana
- MF05D Lima quadrada
- MF05E Lima triangular



MF06S

25.50€

Jogo de 6 mini limas de 100mm

Composição:

- Mini lima redonda
- Mini lima triangular
- Mini lima quadrada
- Mini lima meia cana
- Mini lima plana
- Mini lima plana em bico



MHS100AG

19.00€

Serra

MKS300

19.00€

Serra multi ângulos

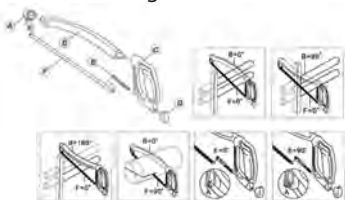
P9601

12.30€

Navalha corta cabos

MK2040

10.20€

 X-ato com lâmina retrátil
Com 2 lâminas de substituição

MK2040-B

1.50€

Lâmina para x-ato MK2040 - 5 unidades

MK2080

11.00€

 X-ato
Botão de segurança lâmina
Inclui 4 lâminas 18x100mm

D

MKS27

22.20€

Jogo de x-ato

Composição:

 X-ato
Raspador
Acessórios

MKS27

Lâmina raspador - 100 unidades

Ref.

Tipo

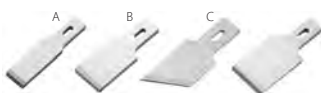
 Medida
(mm)

Preço

MKS27-12	A	12	20.60€
MKS27-16	B	16	22.90€
MKS27-16A	C	(53°) 16	24.00€
MKS27-20	D	20	19.50€

Diversos
MT0201

4.00€

Fita métrica

Corpo em plástico ABS resistente ao choque

Comprimento: 3m

MT0703

8.90€

Fita métrica

Corpo em plástico ABS resistente ao choque

Comprimento: 8m

MTC1

Paquímetro leitura vigésimal

Ref.

 Compr.
(mm)

Preço

MTC1150	150	45.00€
MTC1200	200	71.00€
MTC1300	300	105.00€

MTC153

17.00€

Esquadro metálico

Dimensões: 300x40x1 mm

MTC156

2.80€

Régua metálica

Dimensões: 334x23,7x1 mm

MTC2

Paquímetro digital

Ref.

 Compr.
(mm)

Preço

MTC150	150	67.00€
MTC200	200	109.00€



MTC3
Compasso de precisão pontas direitas

Ref.	Compr. (mm)	Preço
MTC306	150	19.00€
MTC308	200	20.00€

MTC408
Compasso de precisão pontas curvas para exteriores

Comprimento: 200mm

20.50€

MTC508
Compasso de precisão pontas curvas para interiores

Comprimento: 200mm

19.00€

MTM1
Micrómetro exteriores

Ref.	Medida (mm)	Preço
MTM1025	0-25	37.50€
MTM1050	25-50	42.00€
MTM1075	50-75	46.00€
MTM1100	75-100	51.00€

AG010207

84.00€

Gambiarra de Leds

Inclui: Carregador 220v AC/ 5v DC e cabo USB

Dimensões: 375x30x30mm Potência: 15W
 Carregador: 220v/ 50Hz Capacidade da bateria: 2,5 a 10h
 Fluxo luminoso: 410 lumen Tempo de carga: 3,5 a 4h
 Iluminância máxima: 935 lux projetada a 50cm
 Bateria recarregável: Li-ion 3,7v 2 200mAh

AG010224

72.00€

Gambiarra flexível de Leds

Comprimento: 168mm Bateria: Li-ion 3,7v - 2.2Ah
 Carregador: AC/DC Haste flexível 360°
 Base magnética Regulador de intensidade
 Autonomia: 2 a 8h (variável conforme intensidade)

C-DM1

24.80€

Barra magnética

Dimensões: 475x52x17mm



DV13P

Chave phillips isolada (1000 Volts)

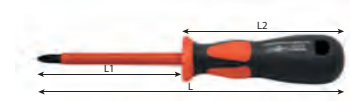

Ref.	Medida	L1 (mm)	L2 (mm)	L (mm)	Preço
DV13P060	PH0	60	98	158	3.70€
DV13P180	PH1	80	104	184	4.30€
DV13P2100	PH2	100	110	210	4.70€
DV13P3150	PH3	150	120	270	6.50€

DV13S

Chave fenda isolada (1000 Volts)

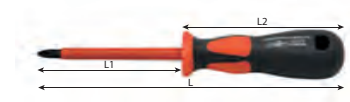

Ref.	Medida (mm)	L1 (mm)	L2 (mm)	L (mm)	Preço
DV13S275	2,5	75	98	173	3.60€
DV13S3100	3x100	100	80	180	4.30€
DV13S4100	4	100	98	198	4.30€
DV13S5125	5,5	125	104	229	4.50€
DV13S6150	6,5	150	110	260	5.90€
DV13S8175	8x175	175	120	295	6.80€

DV13Z

Chave pozi isolada (1000 Volts)



Ref.	Medida (mm)	L1 (mm)	L2 (mm)	L (mm)	Preço
DV13Z060	PZ0x60	60	98	158	3.90€
DV13Z180	PZ1x80	80	104	184	4.80€
DV13Z2100	PZ2x100	100	110	210	5.20€
DV13Z3150	PZ3x150	150	120	270	6.70€

DV13PP07S

42.00€

Jogo de chaves isoladas fenda/ phillips (1000 Volts)

Composição/ medidas (mm):

 Chaves fenda: 4x100; 5,5x125 e 6,5x150
 Chaves phillips: PH0x60; PH1x80 e PH2x100
 Busca-polos

DV41M

Chaves de caixa isoladas com punho (1000 Volts)



Ref.	Medida	Compr. (mm)	Preço
DV41M5	M5	125	7.10€
DV41M6	M6	125	7.10€
DV41M7	M7	125	7.10€
DV41M8	M8	125	7.20€
DV41M10	M10	125	7.30€
DV41M13	M13	125	8.30€

DV4118SV

163.00€

Tabuleiro EVA com ferramentas isoladas (1000 volts)

Composição:

Ref.	Chave	Medida (mm)
DV13S275	fenda	2,5x75
DV13S3100	fenda	3x100
DV13S4100	fenda	4x100
DV13S5125	fenda	5,5x125
DV13P060	phillips	PH0x60
DV13P180	phillips	PH1x80
DV13P2100	phillips	PH2x100
DV13P3150	phillips	PH3x150
DV41M	caixa punho	M4x125; M5x125; M5,5x125; M6x125; M7x125; M8x125; M9x125; M10x125; M11x125 e M12x125

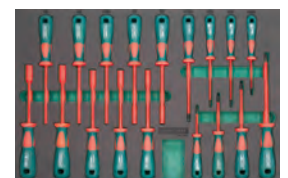

DV41M06S 48.50€

Jogo de 6 chaves de caixa isoladas com punho (1000 Volts)

Composição/ medidas:

Chaves caixa: M5; M6; M7; M8; M10 e M13



DV15109S 36.00€

Bolsa de 7 chaves isoladas (fenda/phillips)



MKV7 11.60€

X-ato isolado 1000V

Comprimento: 180mm

Lâmina: 50mm



MKV7-K 16.50€

Lâmina para x-ato isolado 1000 volts - 4 unidades



MKV8 19.50€

Navalha isolada 1000V

Comprimento: 180 mm

Lâmina: 50mm



PV0118 24.50€

Alicate universal

Cumpr. a norma IEC 60900

Compr. (mm)	4.0	3.0	2.0	1.6
200	<input type="radio"/>	<input type="radio"/>	<input type="radio"/>	<input type="radio"/>



PV08

Alicate universal isolado (1000 volts)

Cumpr. a norma IEC 60900

Ref.	Compr. (mm)	4.0	3.0	2.0	1.6	Preço
PV0816	160	<input type="radio"/>	<input type="radio"/>	<input type="radio"/>	<input type="radio"/>	18.60€
PV0817	180	<input type="radio"/>	<input type="radio"/>	<input type="radio"/>	<input type="radio"/>	20.50€



PV0518 28.00€

Alicate corta cabos (trabalho intensivo)

Cumpr. a norma IEC 60900

Comprimento: 200mm

Capacidade de corte: Ø13/60mm



PV0918 23.70€

Alicate de corte

Cumpr. a norma IEC 60900

Compr. (mm)	4.0	3.0	2.0	1.6
200	<input type="radio"/>	<input type="radio"/>	<input type="radio"/>	<input type="radio"/>



PV1016 19.80€

Alicate de corte diagonal

Cumpr. a norma IEC 60900

Compr. (mm)	4.0	3.0	2.0	1.6
160	<input type="radio"/>	<input type="radio"/>	<input type="radio"/>	<input type="radio"/>



PV1116 19.30€

Alicate de pontas redondas isolado (1000 volts)

Cumpr. a norma IEC 60900

Comprimento: 160mm



PV1118 20.50€

Alicate de pontas

Cumpr. a norma IEC 60900

Compr. (mm)	4.0	3.0	2.0	1.6
200	<input type="radio"/>	<input type="radio"/>	<input type="radio"/>	<input type="radio"/>



PV1218 21.50€

Alicate de pontas redondas

Cumpr. a norma IEC 60900

Compr. (mm)	4.0	3.0	2.0	1.6
200	<input type="radio"/>	<input type="radio"/>	<input type="radio"/>	<input type="radio"/>



PV1416 18.60€

Alicate de pontas chatas

Cumpr. a norma IEC 60900

Comprimento: 160mm



PV1516 19.00€

Alicate de descarnar fios (trabalho intensivo)

Cumpr. a norma IEC 60900

Comprimento: 160mm



PV28110

26.50€

Alicate ajustável

Cumpre a norma IEC 60900

Comprimento: 275mm

PV4006

24.00€

Alicate de pontas redondas

Cumpre a norma IEC 60900

Comprimento: 200mm

PSV218SP

100.00€

Jogo de ferramentas isoladas 1 000V

Composição/ medidas em mm:

2 Chaves phillips isoladas: PH1x80; PH2x100

2 Chaves fenda isoladas: 5x125; 6x150

1 Alicate de corte diagonal

1 Alicate de universal

1 Alicate de pontas

1 Busca polos

B
PSV110SC

163.00€

Jogo de 10 ferramentas isoladas 1 000V

Composição:

4 Alicates

4 Chaves de fenda/ phillips

1 Navalha

1 Busca-polos

C
S03V21
Chaves de caixa 1/4" com isolamento a 1 000V

Ref.	Medida (mm)	Compr. (mm)	Preço
S03V2106	6	41	5.10€
S03V2108	8	41	5.10€
S03V2110	10	41	5.10€
S03V2114	14	41	6.00€

S03V31
Chaves de caixa 3/8" com isolamento a 1 000V

Ref.	Medida (mm)	Compr. (mm)	Preço
S03V3108	8	44,5	7.00€
S03V3110	10	44,5	7.00€
S03V3112	12	44,5	7.20€
S03V3113	13	44,5	7.40€
S03V3114	14	44,5	7.60€
S03V3117	17	44,5	8.20€
S03V3119	19	46	8.70€
S03V3122	22	46	10.00€

S03V41
Chaves de caixa 1/2" com isolamento a 1 000V

Ref.	Medida (mm)	Compr. (mm)	Preço
S03V4110	10	55	8.20€
S03V4111	11	55	8.50€
S03V4112	12	55	8.70€
S03V4113	13	55	8.70€
S03V4114	14	55	9.20€
S03V4117	17	55	9.30€
S03V4119	19	57	9.40€
S03V4122	22	57	11.00€
S03V4124	24	57	11.50€
S03V4127	27	59	13.00€
S03V4132	32	59	16.00€

S03V3116SC

250.00€

Jogo de 16 peças 3/8" com roquete isolado a 1 000V

Composição/ medidas em mm:

RV033 Roquete isolado 200

S43V38 Cabo "T" 200

S25V36 Extensão 150

S25V310 Extensão 250

S03V3 Chaves de caixa: 8; 10; 12; 13; 14; 17; 19 e 22

S09V3 Bits: 4; 5; 6 e 8

B



S03V3136SV

465.00€

Tabuleiro EVA com ferramentas de 1/4" e 3/8" isoladas a 1 000V

Composição/ medidas em mm:

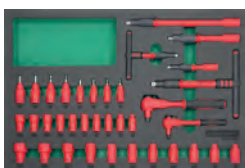
- RV032 Roquete de 1/4"
- RV033 Roquete de 3/8"
- S43V28 Cabo "T" de 1/4" de 125
- S43V38 Cabo "T" de 3/8" de 200
- S25V24 Extensão de 1/4" de 100
- S25V3 Extensão de 3/8" de 150 e 250
- S03V21 10 Chaves de caixa: 5 a 14
- S03V31 11 Chaves de caixa: 8 a 22
- S09V2H 4 Bits de caixa de 1/4" de 60
- S09V3H 4 Bits de caixa de 3/8" de 60



S03V4120SC

355.00€

Jogo de 20 peças 1/2" com roquete isolado a 1 000V

Composição/ medidas em mm:

- RV034 Roquete isolado 250
- S43V48 Cabo "T" 200
- S25V45 Extensão 125
- S25V410 Extensão 250
- S03V4 Chaves de caixa: 10; 11; 12; 13; 14; 17; 19; 22; 24; 27 e 32
- S09V4 Bits: 4; 5; 6; 8 e 10



S03V4124SV

415.00€

Tabuleiro EVA com ferramentas 1/2" isoladas a 1 000V

Composição/ medidas em mm:

- RV034 Roquete de 1/2"
- S43V48 Cabo "T" de 1/2" de 200
- S25V4 Extensão de 125 e 250
- S03V41 13 Chaves de caixa: 10 a 32
- S09V41H 5 Bits de caixa de 200
- WV27AS8 Chave inglesa de 150
- MKV7 X-acto

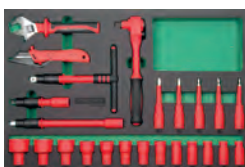

S09V3H



Chaves de caixa hexagonal 3/8" com isolamento a 1 000V

Ref.	Medida (mm)	Compr. (mm)	Preço
S09V3H4	4	60	7.40€
S09V3H5	5	60	7.40€
S09V3H6	6	60	7.60€
S09V3H8	8	60	8.50€

S09V41H



Chaves de caixa 3/8" com isolamento a 1 000V

Ref.	Medida (mm)	Compr. (mm)	Preço
S09V41H4	4	120	10.40€
S09V41H5	5	120	10.40€
S09V41H6	6	120	10.40€
S09V41H8	8	120	10.40€
S09V41H10	10	120	11.50€

S25V3



Extensão 3/8" com isolamento a 1 000V

Ref.	Compr. (mm)	Peso (g)	Preço
S25V36	150	150	25.00€
S25V310	250	250	30.00€

S25V4



Extensão 1/2" com isolamento a 1 000V

Ref.	Compr. (mm)	Peso (g)	Preço
S25V45	150	210	28.00€
S25V410	250	410	31.00€

S43V
Cabo "T" com isolamento a 1 000V

Ref.	Quadra	Compr. (mm)	Peso (g)	Preço
S43V38	3/8"	200	240	36.50€
S43V48	1/2"	250	330	39.00€

RV03
Roquete com isolamento a 1 000V

Ref.	Quadra	Compr. (mm)	Peso (g)	Preço
RV032	1/4"	150	140	41.50€
RV033	3/8"	200	300	50.00€
RV034	1/2"	250	570	58.00€

W23V1
Chaves luneta com isolamento a 1 000V

Ref.	Medida (mm)	Compr. (mm)	Preço
W23V108	8	164	19.00€
W23V110	10	174	19.60€
W23V111	11	184	20.40€
W23V112	12	184	20.40€
W23V113	13	205	22.50€
W23V114	14	205	22.50€
W23V116	16	221	25.00€
W23V117	17	221	25.50€
W23V118	18	237	29.00€
W23V119	19	237	29.00€
W23V121	21	257	32.00€
W23V122	22	257	32.00€
W23V124	24	287	37.50€

W25V1
Chaves de boca 3/8" com isolamento a 1 000V

Ref.	Medida (mm)	Compr. (mm)	Preço
W25V108	8	104	13.50€
W25V109	9	104	14.00€
W25V110	10	114	14.50€
W25V113	13	154	15.70€
W25V114	14	154	16.00€
W25V117	17	170	17.50€
W25V118	18	180	20.00€
W25V119	19	180	20.00€
W25V121	21	202	25.00€
W25V122	22	202	25.00€
W25V124	24	237	26.50€

W25V1125SV
560.00€
Tabuleiro EVA com ferramentas isoladas a 1 000V

Composição/ medidas em mm:

- W23V11 9 Chaves luneta 10 a 19mm
- W25V 13 Chaves bocas 7 a 24mm
- PV0818 Alicates universal 200mm
- PV1016 Alicates de corte 160mm
- PV1116 Alicates de pontas 160mm

WV27AS10
52.50€
Chave ajustável isolada 1000V

 Abertura: 33mm
 Comprimento: 200mm



JONNESWAY®

Ferramentas Profissionais





JONNESWAY®

**Ferramenta Especial
Mecânica**



Mecânica



Pesados



Motociclos



Acessórios



Chapeiro

Ferramenta específica - ramo automóvel
AB030056
40.00€
Insuflador de ar para abertura de portas

Comprimento: 230mm

AB030061
24.00€
Ferramenta para retirar braço do limpa parabrisas

AE040020
68.00€
Cilindro hidráulico

 Comprimento: 140mm fechado | 215mm estendido
 Capacidade: 2t

AE150005
115.00€
Par de preguiças de 3t com apoio em borracha

 Altura máxima: 440mm
 Altura mínima: 290mm

AE300064
245.00€
Kit teste de pressão para radiadores com 17 peças

Composição:

AE30064-02 Audi A4, A5, A6

AE30064-03 Opel, Ford, VW

AE30064-04 BMW

AE30064-05 BMW

AE30064-06 Volvo, Citroën, Renault, Fiat, Peugeot

AE30064-07 Audi, VW

AE30064-08 Sede ajustável

AE30064-09 Pino união 50mm

AE30064-10 Pino união 35mm

AE30064-11 Pino união 27mm

AE30064-12 Adaptador para 8; 9 e 11

AE30064-13 Adaptador

AE30064-14 Fixador

AE30064-15 Honda, Toyota

AE30064-16 Mitsubishi, Honda, Ford, Nissan, Mazda

AE3000
Adaptadores para teste radiadores

Ref.	Preço
AE300064-02	20.50€
AE300064-03	20.50€
AE300064-04	21.00€
AE300064-05	19.00€
AE300064-06	16.50€
AE300064-07	16.50€
AE300064-15	24.80€
AE300064-16	24.80€

AE300100-040
23.10€
Adaptador para kit de pressão de radiadores - Ford

Aplicável no kit AE300064

AE300100-042
23.10€
Adaptador para kit de pressão de radiadores - Ford

Aplicável no kit AE300064

AE300100-060
24.40€
Adaptador para kit de pressão de radiadores - Mercedes

Aplicável no kit AE300064

AE300103
19.70€
Aparadeira de chão para óleo

Dimensões: 600x450x180mm

Capacidade: 16l

AE300152
200.00€
Kit teste de pressão do radiador com 5 peças

AE300173

20.20€

Sangrador de fluido de embraiagem e travões
Fácil, rápido e eficiente utilizando o ar dos pneus



AE300176-A

49.00€

3 Adaptadores especiais para VW/ Audi/ Mercedes



AE300212

117.00€

Distribuidor de óleo de transmissões

Dimensões: 240x200x440mm
Capacidade: 4l
Peso: 1 600g
Bomba manual e 4 adaptadores



AE310002

270.00€

Conjunto de saca hidráulico com acessórios
Capacidade: 90-145mm



AE310006

105.00€

Conjunto de 2 extratores
Capacidade: 30-75mm



AE3100

Separadores meia lua

Ref.	Medida (mm)	Preço
AE310024	30-50	20.50€
AE310025	50-75	33.00€
AE310026	75-105	52.00€
AE310027	105-150	115.00€



AE310008

166.00€

Extrator interior e exterior

Capacidade: 15-30 e 30-80mm interna
15-80mm externa



AE310010A

128.00€

Jogo de extrator semieixo



AE310013

85.00€

Extrator universal de cubo roda

Capacidade: 90-140 e 130-180mm



AE310014

165.00€

Extrator de cubo roda e semieixo

Capacidade: 90-140 e 130-180mm



AE310016

56.50€

Extrator semieixo



AN010045

10.30€

Separador de rótulas



AE3100

Saca de 3 pernas

Ref.	Tamanho	Abertura (mm)	Capacidade (t)
------	---------	---------------	----------------

AE310034	3"	40-76	2
AE310035	4"	50-102	5
AE310037	8"	80-203	12
AE310038	12"	120-305	18

AE310023

49.00€

Extrator de rótulas



Preço

19.70€

27.50€

105.00€

235.00€

AE310062

60.00€

Saca rolamentos longo

Comprimento: 300mm
Capacidade: 10-50mm



AE310063

73.00€

Saca para pequenos rolamentos

Especialmente indicado para remoção de pequenos rolamentos na área automóvel, reparação de equipamentos industriais e domésticos

Capacidade: 1t
Abertura: 19 a 45mm
Profundidade alcance: 73mm



AE310087

85.00€

Extrator universal de rótulas

Especialmente concebido para situações de utilização em espaço reduzido

Aplicável: Audi, VW, BMW, Ford, Mercedes (W170, W202, W210, W220), Opel, Mitsubishi ...



AE310099

120.00€

Extrator 7" de 2 ou 3 pernas para interiores e exteriores

Capacidade: 20t
Abertura: 76-178mm



Alterável para:



AE310066

25.50€

Extrator para volantes de direção

Aplicável: Opel, Ford entre outros



AE310122

94.00€

Extrator de rótulas

Abertura: 32mm



AE310073

30.50€

Extrator de rótulas

Abertura: 20mm



AE310150

85.00€

Saca polies



AE310077

37.00€

Extrator de rótulas

Abertura: 20mm



AE3101
Extrator de rótulas

Ref.	Ø (mm)	Largura (mm)	Altura (mm)	Preço
AE310109A	18	40	35	19.50€
AE310110	23	50	45	42.50€
AE310112	40	80	80	85.00€

AE3101
Saca de 2 braços

Ref.	Ajuste Int. (mm)	Ajuste Ext. (mm)	Altura (mm)	Preço
AE310146B	25-80	70-130	100	57.00€
AE310146D	50-160	105-220	150	100.00€
AE310146E	60-200	120-270	150	130.00€
AE310146G	80-350	160-420	200	312.00€
AE310146H	110-520	195-600	200	452.00€

AE310172
Jogo de sacas

Composição:

Saca de 2ton

Pernas curtas: 85mm

Pernas compridas: 185mm

Saca de 6ton

Pernas curtas: 140mm

Pernas compridas: 280mm

Cilindro de 30ton



840.00€

AE310180
Jogo de saca rótulas com acessórios ajustáveis

Abertura: 20; 22; 24; 27 e 30mm



280.00€

AE310183
Removedor da barra de direção

130.00€

AE320023
Compressor de molas para amortecedores

Abertura: 270mm



40.00€

AE320034
Jogo de extrator de molas MacPherson

525.00€

AE320035
Torno para fixação MacPherson

170.00€

AE320044
Compressor de molas para amortecedores

Abertura: 300mm



72.00€

AE300154B 123.00€

Refratômetro

Aparelho apto para testar líquido de baterias, líquido refrigerante e AdBlue



AE300168 103.00€

Verificador de fugas da cabeça do cilindro

Equipamento destinado a verificar fugas na combustão.

A utilização de líquido contrastante permite verificar a existência de dióxido de carbono no depósito do líquido de refrigeração, denunciando assim a existência de fugas na combustão.



AE300168-1 42.50€

Líquido para verificador da cabeça do cilindro

Embalagem de 250ml

AI020074 150.00€

Detector de fugas para cilindros



AE300201 130.00€

Pistola tornado vaporizadora

Dimensões: 330x105x270mm

Capacidade copo: 1l

Peso: 780g

Ruído: 85dB

Alimentação: 6,2bar

Consumo de ar: 56,6l/min

Entrada de ar: 1/4"



AE300202 125.00€

Pistola tornado vaporizadora/ espuma

Dimensões: 330x105x260mm

Capacidade copo: 1l

Peso: 950g

Ruído: 70dB

Alimentação: 6,2bar

Entrada de ar: 1/4"

Consumo de ar: 56,6l/min



AE300204 22.50€

Seringa para fluidos

Fabricado em plástico resistente a fluido travões e anticongelante. Permite sucção, adição e visualização do fluido

Capacidade: 200cc

Peso: 294g

NÃO utilizar com combustíveis



AE300205 51.70€

Seringa para fluidos

Fabricado em plástico resistente a fluido travões e anticongelante. Permite sucção, adição e visualização do fluido

Capacidade: 1,5l

Peso: 900g

Aplicação: óleo da caixa velocidades e diferenciais

NÃO utilizar com combustíveis



AE300211 95.00€

Seringa para fluidos com 5 adaptadores

Fabricado em plástico resistente e aplicável a todos os tipos de óleos e combustíveis. Permite sucção, adição e visualização do fluido.

Capacidade: 1,5l



AE300206 15.90€

Base de recolha de óleos para latas 20/ 30l

Concebido para recolha de restos de óleo de filtros, novo ou usado, e outros recipientes (encaixe direto em latas de 20/ 30l)

Fabricado em polietileno resistente de alta densidade

Capacidade: 3l

Peso: 500g

Diâmetro: 350mm



AE300207 54.00€

Base de recolha de óleos para bidons 200l

Concebido para recolha de restos de óleo de filtros, novo ou usado, e outros recipientes (encaixe direto no topo de bidons de 200l)

Fabricado em polietileno resistente de alta densidade

Capacidade: 20l

Peso: 1 700g

Diâmetro: 600mm



AE300215
38.00€
Pistola de limpeza de motores

 Bico ajustável
 Capacidade: 1l
 Consumo de ar: 160 l/m
 Entrada de ar: 1/4"
 Pressão de trabalho: 5-8 Bar

AE300220
82.00€
Escorredor de resíduos de óleo

 Dimensões: 174x197x486mm
 Capacidade: 2l

AG010034
6.30€
Caneta magnética

Comprimento: 580mm

AG010035
24.70€
Pesca magnético com luz e espelho

AG010163A
8.70€
Pesca magnético flexível

AG010164
40.00€
Kit de pesca magnético com luz e espelho

Luz: branca, azul e UV

AG010046
9.60€
Ponteira para válvulas dos pneus

Comprimento: 230mm

AG010159
6.50€
Ponteira para mangueira de ar dos pneus

Ponteira: 6mm

AG010059
31.00€
Jogo de 4 saca casquilhos

Medidas: 6; 8; 10 e 12mm

AG010059
Saca casquilhos

Ref.	Medida (mm)	Preço
AG010059-6	6	6.90€
AG010059-8	8	7.00€
AG010059-10	10	7.20€
AG010059-12	12	7.20€

AG010036
8.90€
Bandeja magnética redonda

Dimensões: Ø 150mm

AG010111
29.50€
Bandeja magnética retangular

Dimensões: 240x140mm

AS-0065
39.90€
Suporte magnético para máquina de impacto e 4 chaves

AG010049
9.50€
Jogo de 5 saca pernos

AG010089
17.00€
Medidor digital de pressão de ar

 Baterias de Lítio
 Visor LCD
 Auto calibração
 Auto off

AG010099

32.50€

Chaves de cruz para porcas de rodas

Medidas: 17; 19 e 21mm



AG010225

27.00€

Chave de rodas com 3 peças

Pode ser utilizado em + ou em "T"

Medidas: 17; 19 e 21mm

Tubo perfurado 355mm com chave de 19 e 21mm
Tubo perfurado 395mm com chave de 17mm
Adaptador 1/2"



AG010109

21.00€

Quebra porcas

Medidas: 12-18 e 16-22mm



AG010118A

25.00€

Medidor angular de torque 1/2"



AG010147

13.50€

Chave de aperto angular de torque 1/2"



AG010208

57.00€

Jogo de extratores de parafusos torx danificados com 8 peças

Composição:

Medida (mm)	Compr. (mm)	Hex (mm)
3	38	10
4	38	10
5	38	10
6	38	10
7	38	12
8	38	12
10	38	14
12	38	14



AG10001SP-G

4.30€

Medidor de passo de rosca



AG010227

320.00€

Jogo de machos e caçonetos com 53 peças

Composição:

- 15 Machos 38mm: M6x0,75; M6x1,0; M8x1,0; M8x1,25; M10x1,25; M10x1,5; M12x1,25; M12x1,5; M12x1,75; M14x1,5; M14x2,0; M16x1,5; M16x2,0; M18x1,5 e M18x2,5
- 6 Machos 50mm: M20x1,5; M20x2,5; M22x1,6; M22x2,5; M24x1,5 e M24x3,0
- 21 Caçonetos: M6x0,75; M6x1,0; M8x1,0; M8x1,25; M10x1,25; M10x1,5; M12x1,25; M12x1,5; M12x1,75; M14x1,5; M14x2,0; M16x1,5; M16x2,0; M18x1,5; M18x2,5; M20x1,5; M20x2,5; M22x1,5; M22x2,5; M24x1,5 e M24x3,0

5 Extratores

1 Porta caçonetos

1 Desandador de machos (M6 - M25)

1 Desandador de machos (M4 - M12)

1 Chave phillips PH2 38mm

2 Adaptadores de Ø 50mm



AG010229

148.00€

Jogo de machos e caçonetos com 50 peças

Composição:

- 22 Machos + M3x0,5; M3x0,6; M4x0,7; M4x0,75; M5x0,8; M5x0,9
- 22 Caçonetos: M6x0,75; M6x1,0; M7x0,75; M7x1,0; M8x1,0; M8x1,25; M9x1,0; M9x1,25; M10x1,0; M10x1,25; M10x1,5; M11x1,5; M12x1,25; M12x1,5; M12x1,75 e 1/8NPT27

1 Desandador de machos M6 - M12

1 Desandador em "T" para machos

1 Porta caçonetos

1 Chave phillips

1 Medidor passo rosca

1 Punção



AG10001SP-T
3.60€

Desandador em T para machos

AG10001SP-D
7.70€

Porta caçonetos

AG10001SP-W
8.50€

Desandador macho extensível

Medidas: M4 a M12

AG10002SC-W
6.00€

Desandador macho extensível

Medidas: M3 a M12

AH020002
24.30€

Proteção de guarda-lamas com fixação magnética

Dimensões: 1 050x650mm

AI010006
28.00€

Ferramenta para bloqueio de polias e carretos

AI010009
24.50€
Ferramenta para limpeza das ranhuras de segmentos

Com 3 lâminas circulares para limpeza de pistões (diâmetro: 51 a 127mm)

Lâmina 1: 1/16"; 5/64"; 3/32"; 1/8"; 5/32" e 3/16"

Lâmina 2: 2; 2,5; 3; 4; 4,5mm e 1/4"

Lâmina 3: 1,2; 1,5; 1,8; 2,8; 5 e 5,5mm

AI010017
150.00€

Régua de verificação de empenos do motor

AI010023
14.20€

Esticador de correias

AI010029
75.00€

Saca carretos e polias

AI010030
95.00€

Chave bloqueio da polie da árvore de cames



AI010037

97.00€

Kit comando de motores com 8 peças

Composição:

Marca	Modelo	Aplicação
OPEL	Astra	G 1.7 TD; 2.0 16V
	Vectra	1.8; 2.0 16V >1995
OPEL	Astra	G 1.4 ; 1.6; 1.8 16V
	Vectra	1.6; 1.8 16V
	Zafira	1.6; 1.8 16V
Árvore de cames à direita SAAB	900 - 9000	
OPEL	Calibra	2.5; 2.5L; 2.6 V6
	Cavalier	2.5L V6 2.5; 2.5L; 2.6 V6
	Omega-B	2.5; 2.6; 3.0; 3.2; V6
	Sintra	3.0 V6
	Vectra	2.5L; 2.6 V6
Árvore de cames à esquerda SAAB	900 - 9000	
OPEL	Calibra	2.5; 2.5L; 2.6 V6
	Cavalier	2.5L V6 2.5; 2.5L; 2.6 V6
	Omega-B	2.5; 2.6; 3.0; 3.2; V6
	Sintra	3.0 V6
	Vectra	2.5L; 2.6 V6
ROVER	25	1.4; 1.6; 1.8VVC
	45	1.4; 1.6; 1.8
	75	1.8
	200	VI
	214	16V
	216	16V; Cabrio; Coupé
	218	Coupé
	414	16V
	416	16V; BRM 1.8VVC
	VOLKSWAGEN	Bora
Golf		1.9 TDI
Lupo		1.2; 1.4; 3.0 TDI
Polo		1.4 TDI
Passat		1.9 TFI
CITROËN	Berlingo	1.9 D
	Jumper	1.9 D; TD-FSO 1.9D;
	Jumpy	1.9 D/TD
	Synergie	1.9; 2.0 T
	Xantia	1.9; 2.0 D; TD; HDI
	Xsara	1.9; 2.0 D; TD; HDI
FIAT	Ducato	2.0 D
	Ulysse	1.8; 2.0 Turbo
FORD	Maioria dos Motores Diesel	
PEUGEOT	205	1.6; 1.8; 1.9 D
	305	1.6; 1.8; 1.9 D
	306	1.8; 1.9 D; TD
	309	1.6; 1.9 D
	405	1.6; 1.9 D
	406	1.9 D
	605	2.0 D; TD
	806	1.9 D
	Boxer	1.9; 2.0 D; TD
	Expert	1.9 D
	Partner	1.9 D
	TALBOT	Express
Horizon		D-JSD
Solara		D
ISUZU		Motores Diesel
OPEL	Motores Diesel	1.6; 1.7
	Motores Gasolina	1.2; 1.4; 1.6; 1.8; 2.0



AI010041

113.00€

Kit comando de motores com 19 peças

Composição:

Marca	Modelo	Motorização
CITROËN	Synergie	2.0/Turbo; ZX 1.9D/TD
	Xantia	1.9D/TD
	Berlingo	1.9D
FIAT	Ulisses	2.0/Turbo
	Ducato	2.0
FORD	Fiesta	1.25; 1.4 (95-); 1.8-XR2i/RS1800 16V
	Mondeo	1.6; 1.8; 2.0 16V (93-)
	Escort/Orion	1.6; 1.8i 16V (92-)
HONDA	Accord/Prelude	2.3i (93-);
	Prelude	2.2 V-Tec; motor SOHC
	Accord	1.8; 2.0; 2.2 (-93); 2.0i (93-)
	Shuttle	2.2i;
	Civic	1.6 VTI
	Accord	(90-)
	Prelude	2.0 16V (-90)
LAND ROVER	Discovery MPI	2.0 16V (93-); motor 20T4
MAZDA	121	1.25
OPEL	Cavalier	2.5
	Calibra	2.5
	Vectra	2.5
	Omega	2.5; 3.0
	Sintra	3.0
	Astra	1.8; 2.0 16V
	Cavalier	2.0 16V
	Calibra	2.0 16V/Turbo
	Omega-B	1.6 16V
	Motor Gasolina OHC	1.2; 1.4; 1.6; 1.8; 2.0
	Motor Diesel OHC	1.6D i; 1.7D
	Motor Diesel OHC	1.5D i; 1.7D
	Diesel Isuzu	1.5D i; 1.7D
	205; 305; 309; 405	1.6; 1.9
	405	1.8; 2.0 (92-)
	605	2.0
	Boxer	2.0
	205; 305	1.8; 1.9D
	306	1.8; 1.9D/TD
309	1.8; 1.9D; 1.8TD	
405	1.8TD; 1.9D	
406	1.9D	
Partner	1.9D	
Talbot/Horizon/Solara	1.9D	
J5/Talbot Express	1.9D	
605	1.9D/TD	
806	1.9TD	
Expert	1.9D	
Boxer	1.9D/TD	
RENAULT	R5	1.6D
	R9	1.6D
	411	1.6D
	Express/Extra	1.6D - motores Diesel F8M
	Clio; Express/Extra	1.6D
	R19	1.9D - motor diesel F8Q
	Espace	2.1D
	R21	2.1D
	R25	2.1D
	Trafic/Master	2.1D - motor Diesel J8S
	Clio	1.2; 1.4
	Express/Extra	R19 1.4
	Megane/Scenic	1.4; 1.6 - motor E7F/E7J
	R5	1.7
	Clio	1.7; 1.8
	R19	1.7
	R21	1.7
	Megane/Scenic	2.0
	Laguna	1.8; 2.0
	Trafic	1.7 - motor F3N; F3P; F2R
	Clio Williams; R19; Megane	2.0 16V - motor F7P; F7R;
	Laguna/Safrane	2.0 16V - motor N7Q/N7U
	ROVER	623
618/620		motor SOHC (93-)
216; 416		GTi 16V (-95) motor D16A9, motor K16 DOHC; motor SOHC 820.8V (m8)
Metro		GTa/GTi 16V K16 (-95)
214; 414		K16(89-)
216; 416		K16 (95-)
MGF		1.8 MPI/VVC (95-)
220		M16 (-92)
220		Turbo T16 (92-)
420		M16 (-92)
420		T16 (92-)
320		Turbo M16 (-91)
620		Ti (94-)
820		Turbo T16 Vitesse (91-)
SAAB		900
	9000	3.0 V6
	VW; AUDI; SEAT; SKODA	TDI desde 2000 ECOTEC 1.4; 1.6; 1.8; 2.0 16V



AI010060 65.00€

Jogo de 4 chaves para injetores 1/2"

Composição:

	Faces	Diâmetro (mm)	Medida (mm)
A	6	22	110
B	12	22	75
C	12	27	78
D	12	28	78

AI010060-A 18.50€

Chaves para injetores 1/2"

 Faces: 6
 Diâmetro: 22mm
 Medida: 110mm

AI010060-B 16.70€

Chaves para injetores 1/2"

 Faces: 12
 Diâmetro: 22mm
 Medida: 75mm

AI010060-C 15.30€

Chaves para injetores 1/2"

 Faces: 12
 Diâmetro: 27mm
 Medida: 78mm

AI010060-D 15.40€

Chaves para injetores 1/2"

 Faces: 12
 Diâmetro: 28mm
 Medida: 78mm

AI010063A 55.00€

Medidor de tensão de correias

AI010086 138.00€

Jogo de 12 chaves para terminais

AI010092 78.00€

Bloqueador do volante do motor

AI010104 36.80€

Ferramenta para retirar a tampa do depósito de combustível

Ajustável entre 122-199mm

AI010127 4.80€

Chave de remoção da correia trapezoidal

Aplicação: VOLVO e grupo VAG

AI010137 43.50€

Organizador para peças desmontadas

AI010090A 87.00€

Jogo de 22 chaves para alternador

AI010166 9.20€

Chave torx para polie alternador 1/2"

 Medida: T50
 Comprimento: 110mm

AI010167 9.30€

Chave XZN para polie alternador 1/2"

 Medida: M10
 Comprimento: 110mm

AI010176 40.50€

Chave de remoção do filtro de combustível

Esta ferramenta torna a tarefa rápida e fácil de executar reduzindo os riscos de danificar o alojamento plástico do filtro.

Composição:

Marca	Modelo	Aplicação
CHEVROLET	Captiva, Epica	2.0 VCDi
CITROËN	Hdi Relay	2.0; 2.2; 2.8; 3.0
FIAT	500; Doblo; Strada;	1.3 JTD
	Idea; Panda; Punto	
	Idea; Multipla; Punto;	1.9 JTD
	Sedici (+2.0 JTD)	
	Ducato	2.0; 2.2; 2.3; 2.8; 3.0 JTD
LANCIA	Musa; Ypsilon	1.3 MJTD
OPEL	Agila; Astra; Corsa;	1.3 CDTi
	Combo; Meriva; Tigra	
	Astra; Signum; Vectra;	1.9 CDTi
	Zafira	
PEUGEOT	Boxer	2.0; 2.2; 2.8; 3.0 HDI
SAAB	9-3	1.9 TiD
SUZUKI	Splash; Swift; SX4	1.3 DDiS



AI010195 113.00€

Chave tensionadora de correias com 10 peças



AI020015 24.50€

Grampo para válvulas

Capacidade: 60-120mm
Altura: 150mm



AI0200



Grampo para segmentos

Ref.	Capacidade (mm)	Preço
AI020019	115-180	26.50€
AI020020	70-108	22.50€
AI020021	50-100	20.50€



AI020024 85.00€

Grampo para válvulas

Para motores grandes/ diesel



AI020025 71.00€

Grampo para válvulas

Capacidade: 55-175mm



AI020027 33.30€

Desmonta válvulas universal com gancho

Compressor molas de válvulas

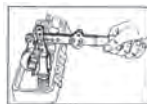

AI020047 23.00€

Extrator das juntas das válvulas



AI020048

Grupo para segmentos

Ref.	Capacidade (mm)	Altura (mm)	Preço
AI020048A	57-125	127	15.50€
AI020048D	90-175	100	17.00€
AI020048E	90-175	165	28.50€



AI020043 20.50€

Alicate para abraçadeiras de folos



AI020049 78.00€

Grampo universal para válvulas



AI020051 225.00€

Kit teste de compressão para motores a diesel

BMW, CITROËN, DACIA, DAF, DAIHATSU, FIAT, FORD, ISUZU, LAND ROVER, MAZDA, MERCEDES, MITSUBISHI; NISSAN, OPEL, PEUGEOT, RENAULT, ROVER, SEAT, TOYOTA, VOLKSWAGEN, VOLVO

Manómetro: 0-70bar

Diâmetro: 80mm

Turbo: 355mm

Adaptadores:

M10x1 (73,5mm); M10x1 (114,5mm);

M10x1 (119mm); M12x1,25 (54mm);

M14x1,25 (72mm) e M20x1,5 (78mm)

Simulador bucal 19 e 21mm



AI020052

160.00€

Kit teste de medição compressão em motores a gasolina

Inclui adaptadores e reparadores com rosca

Medidas: M10; M12; M14 e M18



AI020054

165.00€

Kit teste para a pressão do óleo

Inclui adaptadores e reparadores com rosca

Manómetro: 0-10bar/80mm

Turbo: 1 300mm

Jogo de 10 adaptadores



AI020056A

24.00€

Alicate para juntas de válvulas



AI020066

77.50€

Alicates cinta de segmentos

Abertura: 73-111mm



AI020092

78.50€

Extrator de parafusos danificados

Jogo de brocas/ extrator e guias para remoção de parafusos danificados

Gama: 5 a 16mm



AI020101A

135.00€

Dispositivo para teste de injetores common rail diesel

Este dispositivo permite medir rápida e eficientemente a quantidade de combustível de retorno de cada injetor, permitindo assim verificar se existe alguma anomalia. Medição até 6 injetores em simultâneo.

Inclui adaptadores para injetores Bosch, Delphi, Denso e Siemens.



AI020101A-A

49.50€

Jogo de copos de substituição para AI020101A



AI020103

58.00€

Extrator de inércia para desmontagem de injetores

Feito de aço endurecido de alta qualidade.

Desmontagem rápida e fácil de injetores presos em motores a diesel.

Preparado para rosca M8; M12 e M14



AI020107

167.00€

Ferramenta de ajuste do ponto de injeção

Permite efetuar o ajuste do ponto de injeção em motores diesel com bomba injetora convencional.

Aplicável entre outros em veículos ALFA ROMEO, AUDI, BMW, FIAT, FORD, ISUZU, IVECO, LANCIA, LAND ROVER, MITSUBISHI, NISSAN, RENAULT, ROVER E VOLKSWAGEN.



AI020109 78.00€

Jogo de 6 chaves para velas de incandescência

Composição/ medidas (mm):
Chaves: 8; 9; 10; 12; 14 e 16
Comprimento: 160mm



AI020131 126.00€

Compressor de molas de válvulas

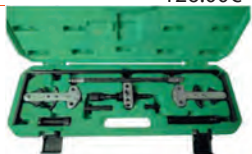

AI020142 385.00€

Jogo de saca rolamentos pequenos

Composição/ medidas (mm):
Saca
Barra
Expansores: 6 a 8; 8 a 10; 12 a 15 e 15 a 18



AI020162 23.50€

Alicate de pontas direitas para remoção de relays



AI020163 23.00€

Alicate de pontas angulares para remoção de relays



AI020178 338.00€

Kit remoção de velas de incandescência danificadas



AI020180 125.00€

Teste de sistemas turbo

Este kit pela insuflação de ar comprimido de baixa pressão no sistema do turbo, permite a verificação de fugas.

Composição: 4 pares de adaptadores

Ø	Medida (mm)
55-60	64
65-70	74
75-80	84
85-90	94



AI020184 15.00€

Chave para injetores MERCEDES BENZ

Quadra: 1/2"
Medida: 17mm
Comprimento: 119mm



AI020184A 14.50€

Chave para injetores BMW e Volkswagen

Quadra: 1/2"
Medida: 14mm
Comprimento: 119mm



AI020184B 15.00€

Chave para injetores MERCEDES BENZ

Quadra: 1/2"
Medida: 19mm
Comprimento: 119mm



AI020184S 40.00€

Jogo de 3 chaves 1/2" para linha de injeção

Composição:

Ref.	Medida (mm)	Aplicação
AI020184A	14	BMW; VW
AI0200184	17	Mercedes 100, 130, 314, 360, 360h, 352A, 346/355, 401, 402, 403, 407h, 615, 616 e 617
AI0200184B	19	Mercedes 314, 352, A, 346/355, A, 401, 402/422, LA, 403, 407



AI020185 18.50€

Chave luneta aberta dobrada

Chave especial para desmontar tubos de alta pressão do sistema de combustível em motores a diesel

Medidas: 17x17mm



AI020201

67.00€

Jogo de 6 chaves de caixa com luneta aberta

Especialmente concebidas para trabalhar em espaços apertados e de difícil acesso.

Quadra: 1/2"

Comprimento: 100mm

Medidas: 12; 14; 16; 17; 18 e 19mm



AI020205

128.00€

Saca para injetores (diesel/ gasolina)

Saca especialmente concebido para a remoção de injetores Diesel e Gasolina. As garras são intermutáveis o que permite abranger um maior número de tipos de injetores.



AI030007

18.50€

Jogo de 5 peças para raspar, limpar e tirar juntas



AI050043S

21.50€

Jogo de 3 raspadores

Medidas: 15; 20 e 30mm



AI030010

4.40€

Ferramenta para rodar válvulas grandes



AI030011

4.00€

Ferramenta para rodar válvulas pequenas



AI030020

19.70€

Estetoscópio de mecânico



AI030025

6.50€

Jogo de riscador/ tira o' rings e juntas



AI030027

42.50€

Jogo de 6 riscadores com punho



AI040007

12.70€

Alicate para segmentos

Medidas: 1,2 a 6,3mm



AI040008

101.00€

Kit completo para teste de vácuo e sangrar travões



AI040031

145.00€

Bomba para vácuo e pressão com kit sangrador travões

Selecionar a válvula de controlo para a função de vácuo ou pressão.



AI040005

18.00€

Alicate de pontas curvas para anéis de segurança



AI040006 18.00€

Alicate de pontas direitas para anéis de segurança



AI040011 15.80€

Alicate para velas com pontas isoladas



AI040017 58.50€

Jogo de alicates de freios de cabeças recambiáveis

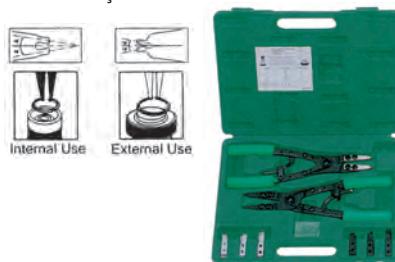

AI040018 21.50€

Alicate para abraçadeiras



AI010201 91.00€

Chave flexível para tubos de combustível

Permite trabalhar em locais com pouco espaço.



AI040060 28.60€

Alicate para tubos de combustível

Alicate para ligações rápidas de tubos de combustível.



AI040246 43.00€

Jogo para desligar tubos de combustível

Composição:

- 1 Chave direita para tubos 11,8mm
- 1 Chave direita para tubos 16mm
- 1 Chave angular para tubos 11,8mm
- 1 Chave angular para tubos 16mm



AI030002 29.00€

Jogo de 11 chaves para bujões óleo

Quadra: 3/4"

Utilização: chave de caixa 19mm

Hexagonais

8mm: BMW/ FORD/ GM

9mm: GM

10mm: FORD

12mm: FIAT/ LANCIA/ PEUGEOT/

14mm: LANCIA/ MERCEDES

17mm: AUDI/ BMW/ DAC

Quadradas + cabo

8mm: PSA/ RENAULT/ VOLVO

9,5mm: HONDA/ MAZDA/ PEUGEOT/ SAAB/ VOLVO

11mm: FORD

13mm: NISSAN/ SUBARU



AI050004 59.70€

Jogo de 15 peças de copo para filtros

Composição:

Faces	Medidas (mm)	Aplicação
14	65	GM, DAIHATSU, TOYOTA
14	65-67	DAIHATSU
14	68	MAZDA, FORD ESCORT, SUBARU
14	73	TOYOTA, LEXUS
15	74-76	SATURN
15	75-77	VW, AUDI, FORD, ISUZU, MERCEDES, OPEL
14	76	VW, PORSCHE, MERCEDES, BMW, AUDI A3, OPEL
30	76	FORD
15	80	NISSAN, HONDA, MAZDA, ISUZU, SUBARU, OPEL, TOYOTA
15	80-82	MAZDA, SUBARU, TOYOTA, HONDA, ACURA, NISSAN
15	90	HONDA ACCORD, MITSUBISHI, ISUZU
15	93	OPEL, MAZDA, VOLVO, MITSUBISHI, NISSAN, VW, PORSCHE, RENAULT, FORD, HONDA, AUDI
36	93	FORD
15	100	ISUZU, MITSUBISHI

Adaptador 1/2" (F)x3/8" (M)



HC
Chaves de copo para filtros

Ref.	Faces (mm)	Medida (mm)	Preço
HC-78/15	15	78	4.90€
HC-65/67	14	65-67	4.70€
HC-65/14	14	65	5.40€
HC-68/14	14	68	4.80€
HC-74/15	15	74	5.00€
HC-66/6	6	66	4.80€
HC-76/8	8	76	4.90€
HC-73/14	14	73	5.00€
HC-74/76	15	74-76	5.20€
HC-75/77	15	75-77	5.20€
HC-76/12	12	76	5.00€
HC-76/30	30	76	5.00€
HC-93/36	36	93	5.00€
HC-76/14	14	76	5.00€
HC-108/15	15	108	4.70€
HC-108/18	18	108	5.00€
HC-65103		65-120	17.00€
HC-106/15	15	106	5.40€
HC-100/15	15	100	5.10€
HC-86/16	16	86	5.10€
HC-90/15	15	90	5.10€
HC-80/82	15	80-82	4.70€
HC-92/10	10	92	5.10€
HC-93/45	45	93	5.10€
HC-93/15	15	93	5.10€
HC-86/18	18	86	5.00€
HC-80/15	15	80	5.00€
HC-96/18	18	96	5.00€
HC-95/15	15	95	5.20€
HC-9.5mm	adaptadores 1/2"-3/8"		2.00€

AI050004A
140.00€
Jogo de 30 peças de copo para filtros
Composição:

Faces	Medida (mm)	Aplicação
14	65	GM, DAIHATSU, TOYOTA
14	65-67	DAIHATSU
14	68	MAZDA, FORD ESCORT, SUBARU
14	73	TOYOTA, LEXUS
15	74	AUDI, GM, ROVER, CHRYSLER
15	74-76	SATURN
15	75-77	VW, AUDI, FORD, ISUZU, MERCEDES, OPEL
8	76	FIAT MAREA, LANCIA DELTA
12	76	FIAT (DUCATO, SCUDDO, ULYSSE), RENAULT (MEGANE, LAGUNA, ESPACE)
14	76	VW, PORSCHE, MERCEDES, BMW, AUDI A3, OPEL
30	76	FORD
15	78	NISSAN, FORD, TOYOTA
15	80	NISSAN, HONDA, MAZDA, ISUZU, SUBARU, OPEL, TOYOTA
15	80-82	MAZDA, SUBARU, TOYOTA, HONDA, ACURA, NISSAN
16	86	Volvo (S40, S60, S70, S80)
18	86	VW (GOLF TDI, PASSAT/TDI), AUDI A6 TDI, RENAULT (CLIO, RAPID 1.9D, LAGUNA, SAFRANE, ESPACE 2.1D, CITROEN; PEUGEOT
15	90	HONDA ACCORD, MITSUBISHI, ISUZU
10	92	FIAT (CINQUECENTO, COUPE, CROMA, PANDA, REGATA, RITMO, SEICENTO, TEMPRA, TIPO), LANCIA (BETA, DEDRA, KAPPA, THEMA)
15	93	OPEL, MAZDA, VOLVO, MITSUBISHI, NISSAN, VW, PORSCHE, RENAULT, FORD, HONDA, AUDI
36	93	FORD
45	93	VW AUDI (2.4; 2.6; 2.8L)
15	95	TOYOTA, ALFA, GM, FORD, CHRYSLER
18	96	AUDI (A4, A6TDI), VW (PASSAT 97 TDI), RENAULT (LAGUNA 2.2D, SAFRANE 2.2D, ESPACE 2.2D, R19, RAPID, MEGANE 1.9/2.1D)
15	100	ISUZU, MITSUBISHI
15	106	FIAT DUCATO 2.5 TD
18	108	RENAULT (ESPACE, LAGUNA, MASTER, SAFRANE, TRAFFIC 2.4; 2.5; 2.8D)
15	108	

 Chave filtro de óleo ajustável 65-120
 Adaptador 1/2"(F)x3/8"(M)

AI050009A
8.80€
Chave de filtros

AI050022

11.30€

Chave de filtros

Ajustável: 60-90mm



AI050024

22.00€

Jogo de 4 alavancas

Medidas: 200; 330; 540 e 600mm



AI050001

19.70€

Chave de filtros de 3 pernas

Capacidade: 60-120mm



AI050037

19.50€

Chave de filtros de 3 pernas

Capacidade: 45-110mm



AI030067

42.90€

Jogo de 17 chaves para bujões de óleo 3/8"

Composição:

6 Chaves hexagonais: 8; 9; 10; 11; 12; 13 e 14mm

9 Chaves quadradas: 7; 8; 10; 11; 12; 13 e 14mm 5/16" e 3/8"

1 Chave quadrada (fêmea): 10mm

1 Chave triangular



AI050040

11.30€

Chave para bujões

Medidas: 8 e 10mm



AI050175

18.00€

Chave para remover/ instalar o alojamento plástico dos filtros de óleo

Aplicação: Motores TDCI - HDI - Ford, Peugeot, Citroën



AN010009A

7.20€

Chave para bujões de carter

Medidas (mm): 10; 11; 12; 13; 14; 15 e 17mm

Comprimento: 150mm



AN010030

13.50€

Alicate para remoção de pesos de rodas



AI050042

17.70€

Chave para remoção de ventoinha

Medidas: 8 e 10 mm



AI050043

19.90€

Alicate de pressão para filtros de óleo

Medida: 53-118mm



AI050076

59.50€

Chave de filtros ajustável 1/2"

Medida: 60-80mm



AI050077

18.00€

Chave de filtros de cinta

Medida: 25-160mm



AI050080

10.00€

Chave para parafusos cabeça do motor 1/2"

Medida: M9

Comprimento: 100mm



AI05009

Chave de velas longa 3/8"

Ref.	Medida (mm)	Compr. (mm)	Preço
AI050092	14	250	15.00€
AI050093	16	250	17.40€

AI050096S

55.50€

Jogo de 7 chaves especiais

 Sensores de vácuo e de oxigénio
 Válvulas pressostáticas

AI050102

80.00€

Chave de filtros 3 pernas auto ajustáveis

Capacidade: 95-165mm

AI050202

9.50€

Chave de copo para filtros de 14 faces 3/8" com 54mm

Marca	Modelo	Motorização
TOYOTA	Auris/ Corolla/ Prius	1.8/ 2.0 4 cilindros

AI010033

7.30€

Chave para sensor de oxigénio

AI050104

21.80€

Chave para sensor de oxigénio

Medida: 22mm

AI050109

49.50€

Chave de filtros de corrente

 Comprimento: 350mm
 Filtros: 60 a 105mm

AI050113

194.00€

Jogo de bits impacto de 3/4" e 1"

 Composição/ medidas (mm):
 5 Chaves torx T60, T70, T80, T90 e T100 (107mm)
 4 Chaves hexagonais 17, 19, 22 e 24mm (107mm)
 4 Chaves torx E18, E20, E22 e E24 (107mm)
 1 Chave sextavada 3/4" 22mm
 1 Chave sextavada 1" 22mm
 1 Chave hexagonal em L 4mm

AI050152

20.00€

Tubo para descarga de óleo usado do alojamento do filtro

AI050152A

12.80€

Tubo para descarga de óleo usado do alojamento do filtro

Aplicação: TOYOTA e LEXUS

AI050176

199.00€

Kit para montagem de correias estriadas com 11 peças

Composição:

Marca	Modelo
AUDI	A3
BMW	118/ 120/ 318/ 325/ 330/ 335/ 520/ 525/ 530/ 535/ 635/ 720/ 730/ X3/ X5
CITROËN	C2/ C3/ C4/ Jumper/ Relay
CHRYSLER	Grand Voyager/ Voyager
FIAT	Albea/ Doblo/ Ducato/ Fiorino/ Marea/ Multipla/ Qubo/ Linea/ Palio/ Siena/ Stilo e Strada
FORD	C-Max/ Courier/ Fiesta/ Focus C-Max/ Fusion/ Mondeo/ Tourneo/ Transit
IVECO	Daily
LANCIA	Lybra
MAZDA	2/ 3/ 5/ Axela
MERCEDES	Sprinter/ Viano/ Vito
MITSUBISHI	ASX
PEUGEOT	206/ 207/ 307/ Boxer
SEAT	Altea/ Ibiza
SKODA	Octavia/ Yeti
VOLKSWAGEN	EOS/ Golf/ Passat/ Polo/ Sirocco
VOLVO	C30/ S40/ V50



AL010093 31.00€

Ferramenta para montagem/ desmontagem de correias elásticas poli-v



AI050191 12.70€

Chave magnética para bujões



AE300180 47.00€

Funil para líquido refrigerante

Dimensões: 160x160x260mm

Funil + 2 adaptadores



AE300179-02 41.00€

Adaptadores para funil líquido refrigerante AE300180



AE300179-03 41.00€

Jogo de 6 adaptadores para funil líquido refrigerante AE300180

Adaptadores para veículos Europeus.



AE300221

Adaptadores para funil líquido refrigerante AE300180

Ref.	Aplicação	Preço
AE300221-02	Veículos Japoneses	15.50€
AE300221-03	Honda, Toyota	22.00€
AE300221-04	Ford, Mazda, Mitsubishi, Nissan	16.00€



AI050192 38.50€

Funil universal para óleo

Grampo de fixação ajustável: 28-74mm



AI060006 8.60€

Reparador "roscas" alojamento de velas

Medida: 14mm



AI060020 3.80€

Apalpa folgas com 20 lâminas

Medidas (mm): 0,05; 0,10; 0,15; 0,20; 0,25; 0,30; 0,35; 0,40; 0,45; 0,50; 0,55; 0,60; 0,65; 0,70; 0,75; 0,80; 0,85; 0,90; 0,95 e 1

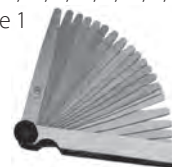

AI060030 185.00€

Kit de reparação de roscas de alojamento de velas com 56 peças



AI060030

Helicoides

Ref.	Medida	Quadra	Quantid.	Preço
AI060030-A	M10x1,0	3/8	10	6.90€
AI060030-B	M12x1,25	3/4	10	13.50€
AI060030-C	M14x1,25	7/16	10	16.80€

AI060030
Punção

Ref.	Medida	Quantid.	Preço
AI060030-D	M10x1,0	1	11.50€
AI060030-E	M12x1,25	1	14.50€
AI060030-F	M14x1,25	1	20.70€

AI060031
135.00€
Kit reparador de roscas com 87 peças

Composição:
 Helicoides: 25x M6x1.0x1.5 (9mm)
 25x M8x1.25x1.5 (12mm)
 25x M10x1.5x1.5 (15mm)

Macho: M6x1.0
 M8x1.25
 M10x1.5

Punção: M6x1.0
 M8x1.25
 M10x1.5

Broca: 6,3mm
 8,3mm
 10,4mm

Punho: M6x1.0
 M8x1.25
 M10x1.5

AI060031
Helicoides

Ref.	Medida	Quantid.	Preço
AI060031-A	M6x1,0	10	5.20€
AI060031-B	M8x1,25	10	6.40€
AI060031-C	M10x1,5	10	8.20€

AI060031
Punção

Ref.	Medida	Quantid.	Preço
AI060031-D	M6x1,0	1	6.90€
AI060031-E	M8x1,25	1	9.20€

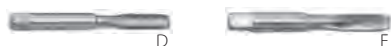
AI060031
Broca

Ref.	Medida (mm)	Quantid.	Preço
AI060031-G	6,6	1	4.80€
AI060031-H	8,3	1	8.30€
AI060031-J	10,4	1	12.00€

AL010006
32.50€
Jogo de 3 alicates

Para ligações rápidas de tubos de combustível

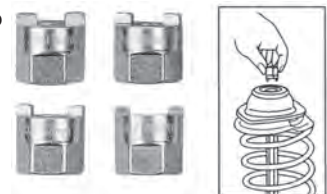
AL010011
23.20€
Chave para fêmeas suspensão

AL010073
174.00€
Kit para remoção das cabeças dos amortecedores

Aplicação: BMW, Fiat, Honda, Mercedes, Mitsubishi, Nissan, Opel, Peugeot, Renault, Suzuki, Toyota e Volvo

AN010001
51.00€
Kit de ferramenta para travões com 11 peças

Para recuar e rodar êmbolos dos travões

AN01001C
64.00€
Kit de ferramenta para travões com 18 peças

Para recuar e rodar êmbolos dos travões



AN010001D

180.00€

Kit de ferramenta para travões
Para recuar e rodar êmbolos dos travões



AN010001D

Adaptadores

Ref.	Marca	Preço
AN010001D-2	Citroën, Honda	6.80€
AN010001D-3	Vários	7.20€
AN010001D-4	Vários	4.70€
AN010001D-5	Adaptador 3/8"	6.20€
AN010001D-6	Nissan, VW	4.60€
AN010001D-7	Vários	4.60€
AN010001D-A	Renault	4.60€
AN010001D-E	Nissan, Ford	4.60€
AN010001D-F	Opel	4.60€
AN010001D-K	Citroën	7.40€
AN010001D-M	Vários	4.60€
AN010001D-N	Ford, Mazda, Mini	4.60€



AN010293

35.70€

Chave especial para pressionar as pinças de travão



AN010102

15.00€

Alicate para comprimir a mola do travão de mão



AN010321

24.00€

Alicate para cabo do travão de mão



AN010322

37.00€

Alicate para molas de travões do tambor



AN010033

5.80€

Removedor do interior de válvulas



AN010085A

14.80€

Ferramenta para colocar válvulas de pneus



AN010038

7.70€

Extrator de vedantes



AN010049

13.00€

Centrador de embraiagens



AN010063

68.00€

Alicate para freios de travão



AN010065

67.00€

Jogo de 4 pinças para cilindros de travão



AN010081A

23.50€

Alicate de molas de travões



AN010160

20.00€

Ferramenta para verificação da altura dos calços de travão



AN010066

46.00€

Kit de desmontagem de embraiagem do compressor A/C
Aplicável em várias marcas de compressores A/C



AN010054A

22.50€

Jogo de 3 alicates para oclusão de tubos



AN010054N

23.50€

Alicate de pressão para tubos



AR060062

36.60€

Alicate tensor para abraçadeiras de tubos
Amplitude: 5 a 55mm



AN010068

6.00€

Limpa bornes e terminais de bateria



AN010072

30.00€

Reparador de roscas interno e externo
Medidas das roscas: 0,8; 1; 1,25; 1,50; 1,75; 2 e 3mm



AN010072C

18.60€

Reparador de roscas SAE (polegadas)
Medidas das roscas: 9"; 10"; 16"; 20"; 27"; 28" e 32"



AN010091A

99.90€

Removedor da barra de direção

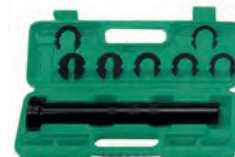

AN010092

72.00€

Chave excêntrica para direções/ barras
Medida: 33-42mm



AN040327

27.00€

Ferramenta de ajuste do eixo traseiro MB



AI030075

27.70€

Alicate para tubos de escape



AN010106A

49.50€

Corta tubos de escape
Não utilizável em tubos de aço inox
Medidas: 19 a 76mm de diâmetro



AN010106A-C

28.00€

Corrente de corte para corta tubos de escape



AN010112

20.50€

Adaptador para saca de semieixo



AN010131

18.30€

Rolete calcador



AN010137 81.50€

Alicate para cubos de rodas



AN010186B 625.00€

Kit para embraiagens auto ajustáveis



AN010188

Ferro desmonta pneus



Ref.	Medida (mm)	Preço
AN010188A	500	23.00€
AN010188B	350	11.00€
AN010188C	200	4.70€

AN010225 595.00€

Ferramenta para instalar/ remover rolamento manga eixo

Permite rapidez, segurança e profissionalismo sem esforço na tarefa

Aplicação: PEUGEOT, CITROËN e RENAULT



AN010226 18.20€

Medidor de espessura dos discos de travão e profundidade do piso dos pneus

Discos de travão: 0-60mm

Material: alumínio



AN010319 122.00€

Medidor digital da espessura dos discos de travão e profundidade da espessura pneus

Capacidade medição: 0-100mm



AN010320 77.00€

Medidor dos discos de travão



AG010205 20.00€

Medidor digital de profundidade

Utilizado para medir a profundidade do piso dos pneus e das pastilhas de travões.

Especificações:

Gama de medição: 0-25,4mm

Resolução: 0,01mm

Display: LCD

Medição em milímetros ou polegadas.

Utiliza pilhas SR44/ LR44 de 1,4V (não incluídas).



AN010272 14.50€

Alicate para tampas plásticas fêmea da roda

Permite retirar as tampas plásticas das fêmeas da roda sem danificar as jantes.



AN010279 365.00€

Mecanismo para desbloqueio de roda MB/ BMW

Aplicação

Mercedes Benz: W164 (Classe GL); W197 (SLS); W204 (Classe C); W212 (Classe E); W221 (Classe S) e W251 (CLR)

BMW: F01/F02 (Série 7); F07/F10 (Série 5);

F12/F13 (Série 6); F25 (x3) e

F30/ F31/ F32/ F33/ F34 (Séries 3 e 4)



AN020007 30.00€

Despolidor de cilindros

Medida: 51-177mm



AN020007-1 12.70€

Jogo de 3 pedras para despolidor de cilindros

Aplicável ao despolidor AN020007

AN020022
31.00€
Jogo de despolidor de cilindros

Composição/ medidas (mm):

Medida: 18-89

Pedras: 19; 28,8 e 51

Jogo de pedras de substituição

AN020022
Jogo de pedras para despolidor de cilindros

Ref.	Medida (mm)	Unidades	Preço
AN020022-A	51	3	8.60€
AN020022-B	28,8	2	6.20€
AN020022-C	19	3	5.80€
AN020022-D	28,8	2	5.50€

AN040035A
17.90€
Corta tubos

AN040043A
60.00€
Jogo de cortar tubos e abocardador

Composição/ medidas (mm):

Fixador de tubos: 4; 6; 8; 10; 12; 15 e 16

Punções abocardador: 4; 6; 8; 10 e 12

AN040082
127.00€
Jogo de extrator de fêmeas danificadas com 9 peças 3/8"

Medidas: 10; 11; 12; 13; 14; 15; 16; 17 e 19

AN040101
7.80€
Bit 1/2" pentagonal para freios travões

AN040168
440.00€
Jogo de ferramenta para instalar/ remover rolamentos de roda

Permite rapidez, segurança e profissionalismo sem esforço na tarefa

Para rolamentos: 60 a 85mm

AR020018
24.00€
Teste de compressão

Tubo flexível com adaptador: 14 e 18mm

 Escalas: 0-300psi; 21kg/cm²; 21bar e 2 100kpa

AR020019
24.00€
Teste de vácuo e bomba combustível

AR020053A
240.00€
Kit de acessórios eletricista/ eletrónica auto

AR030013
4.30€
Densímetro para líquido de baterias

AR030034
6.50€
Auto tester circuitos entre 3-48V

Indicação da polaridade por Leds



AR030041

68.00€

Jogo de 7 aplicadores de o'ring

Composição/ medidas (mm):
14,4-16; 15,9-17,5; 17,5-19,1; 20,7-22,4;
24-26; 25,5-27,5 e 30,3-32,3



AR030047

25.00€

Teste fluido de travões
Bateria não incluída.



AR030062

41.50€

Teste de atuadores

Este aparelho permite o teste a componentes eletrónicos que atuam por campos magnéticos e eletromagnéticos.



AR040043

17.00€

Saca terminais de cabo de bateria e limpa parabrisas



AR040016

82.00€

Jogo de cabos de arranque de bateria 500 Amp

Dimensões: 0.3x268x12mm
Comprimento: 3 600mm



AR06002A

25.50€

Alicate para abraçadeiras - matriz "+"



AR060003

17.00€

Alicate para abraçadeiras - matriz "V"



AR060008

17.80€

Alicate para abraçadeiras de filtros de combustível e tubos de vácuo



AR060038

20.00€

Alicate angular para abraçadeiras tubos



AR060039A

19.20€

Alicate para abraçadeiras tubos



AR060055

25.80€

Alicate de abraçadeiras de tubos

Abertura de 22 a 55mm



AR060056

29.00€

Alicate abraçadeiras tubos

Medida: 0-38mm



AR060010

23.30€

Alicate para tubos do radiador



AR060011

11.80€

Dispositivo para bloquear tubos



AR060020

14.50€

Alicate para remover tubos



AR060021

49.50€

Alicate para abraçadeiras



AR060024A
175.00€

Kit de 7 alicates para abraçadeiras

AN010177B
58.00€

Alicete especial para abraçadeiras de fole

AR060029
54.00€

Alargador de foles

AR060032
18.80€

Kit de adaptadores para descaixe de tubos A/C

AR060043
120.00€

Jogo de 52 peças para remoção de rádios

Aplicação:

Marca Auto: AUDI; BMW; FIAT; FORD; SKODA;

MERCEDES; OPEL; PORSCHE e VOLKSWAGEN

Marca Rádio: Becker; Blaupunkt; Clarion; JVC;

Grundig; Kenwood; Panasonic; Pioneer e Sony

**Ferramenta - aplicação especial por MARCAS
GRUPO BMW e MINI**
AI010121
68.00€

Chave para boia do depósito de combustível

 Aplicação: AUDI, BMW, MERCEDES,
PORSCHE e VOLKSWAGEN

AI010139
122.00€

 Ferramenta para desmontagem do sensor
do nível de combustível

Aplicação: BMW e MINI

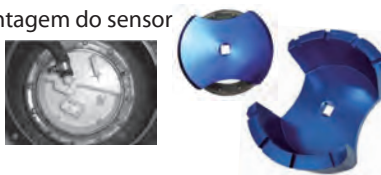
AL010099
275.00€

Kit comando de motor diesel BMW

Modelo	Motorização
E34/ E36/ E38/ E39/ E46/	M41/ M51/ M47TU/ M47T2/
E53/ E60/ E61/ E63/ E65/	M57TU/ M57T2
E66/ E70/ E83/ E87/ E90/ E91/	
Land Rover	2.5DT/ 3.0TD6/
Freelander	2.0TD4

AL010128
59.50€

Kit comando de motor BMW

Modelo	Motorização	Ano
118d	E87	2003-2007
120d	E87	2003-2007
318d/td	E46 E90/91	2000-2008
320d/crd	E46 E90/91	1997-2008
325d	E90/91/92/93	2006-2010
330d/xd/crd	E46 E90/91/92/93	1998-2008
510d	E39 E60/61	1999-2010
525d/xd	E39 E60/61	1999-2010
530d/xd	E39 E60/61	1998-2010
535d	E60/61	2004-2010
635d	E63/64	2004-2010
730d	E38 E65/66	2003-2010
X3 2,0d	E83	2003-2007
X3 3,0d	E83	2003-2010
X5		

AI010115
29.70€

Sacas bombas injetoras BMW

Modelo	Motorização
318D/ 320D/TD/ 330D	E46
525D/ 530D	E39
525D/ 530D/ 535D	E60/E61
730D	E38
X5 3,0D	E53



AI020184A

14.50€

Chave para injetores BMW e Volkswagen

Quadra: 1/2"

Medida: 14mm

Comprimento: 119mm



AI050071S

347.00€

Jogo de 8 chaves especiais BMW

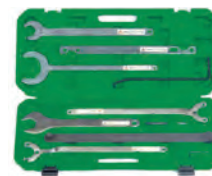

**Ferramenta - aplicação especial por MARCAS
FIAT e OPEL**

AL010044

155.00€

Kit comando de motor FIAT/ OPEL

Marca	Modelo	Motorização	Ano	Peças nº
FIAT	Panda/ Idea/ Doblo	1.3JTD MultiJet	2004-2007	7; 8; 9; 10
		1.7D/ 1.9D/ TD/ JTD2.4		1; 3; 4
		1.9/ 2.4JTD 16V/ 20V		2; 3; 4; 5; 6; 7
OPEL	Agila/ Corsa/ Astra H/ Tigra B/ Meriva/ Astra/ Vectra/ Signum/ Zafira	1.3CDTI	2004-2007	7; 8; 9; 10
		1.9CDTI		2; 3; 4; 5; 6; 7
ALFA ROMEO	147/ 156	1.9JTD 16V/ 2.4JTD 20V		2; 3; 4; 5; 6; 7



AL010196

55.00€

Kit comando de motor gasolina

Marca	Modelo	Motorização
ALFA ROMEO	159	939A4.000
CHEVROLET	Aveo/ Cruze/ Orlando	
FIAT	Croma	939A4.000
OPEL	Astra G/ Astra H/ Corsa D/ Meriva A/ Zafira B/C/ Vectra C/ Signum/ Insignia	Z16LEL/ Z16LER/ Z16LET/
		Z16ZE1/ Z16XEP/ Z16ZER/ LLu/
		A16LET/ A16XEL/
		2HO/A18XEL/ 2HO/A18XE R/Z18XER



**Ferramenta - aplicação especial por MARCAS
FORD, MAZDA e VOLVO**

AL010070

26.00€

Kit comando motor FORD/ PEUGEOT/ CITROËN

Marca	Modelo	Motorização:
FORD	Fiesta/ Fusion	1.4TDCI
	Focus/ Focus C-Max	1.6TDCI
	Fusion/ Fiesta	1.6TDCI
CITROËN	C4	1.6HDI
PEUGEOT	206	1.4HDI
PEUGEOT	307	HDI



AL010071

81.00€

Kit comando motor FORD

Modelo	Motorização	Ano
Fiesta	1.8D Turbo	
Focus		
Focus C-Max	1.8TDCI	
Tourneo Connect	1.8TDDI/ TDCI	
Transit Connect	1.8TDDI/ TDCI	2002-2006



AL010107

80.00€

Kit comando motor FORD

Modelo	Motorização em diesel
Fiesta	1.8TDDI/ TDCI
Focus	Turbo
Transit	
Transit Connect	



AL010175

32.50€

Pino de fixação árvore de cames

Marca	Modelo	Motorização	Ano
FORD	Fiesta/ Fusion	1.4TDCI	2002>2009
	Focus C-Max	1.4/ 1.6TDCI	
	Mondeo	2.0TDI/ TDCI/ 2.2TDCI	
	Transit	2.0TDI/ TDCI/ 2.4TDI/ TDCI	
	VOLVO	S40/ V50	



Ferramenta - aplicação especial por MARCAS FORD, MAZDA e VOLVO

AL010205

8.70€

Kit comando motor FORD/ MAZDA/ VOLVO

Marca	Modelo	Motorização
FORD	C-Max/ Cougar/ Fiesta/ Focus	HWDA/ HWDB/ CSDA/ QQDA/ QQDB/ QQDC/ AODA/ AODB/ DBA/C/ EDBB/ EDBD/ F8JA/ F8JB/ FUJA/ FUJB/ M7JA/ M7JB/ FXJA/ FX JB/ FYJA/ FYJB/ N4JB/ FHA/ FHE/ L1T/ L1V/ ASDA/ ASDB/ FXDA/C/ FXDB/D/ FYDA/C/ FYDB/D/ EYDB
MAZDA	6	
VOLVO	C-30/ S40/ S80/ V50/ V70	B4164S3/ B4184S11/ B4204S3



AL010218

157.00€

Kit comando motor FORD

Modelo:

Fiesta/ Fusion/ Focus/ C-Max/ B-Max/ S-Max/ Mondeo/ Galaxy



AN040286

350.00€

Extrator de sinoblocos

Marca	Modelo	Ano
FORD	Focus I	1998-2005
	Focus II	2004-2008
	CB4	2008-2011
MAZDA	3	2003-2008
	3	2009 ->
	5	2005-2010



Ferramenta - aplicação especial por MARCAS HYUNDAI e KIA

AL010282

69.00€

Kit comando motor HYUNDAI/ KIA

Aplicação:

HYUNDAI: Accent; Elantra; Getz; i10; i20; i30; i40; ix35; ix55; Matrix e Tucson.

KIA: Carens; Cee'd; Cerato; Optima; Picanto; Pro-Cee'd; Rio; Soul; Sportage e Venga.



Ferramenta - aplicação especial por MARCAS MERCEDES

AG010204

10.00€

Chave de impacto para rodas especial - MERCEDES 1/2" com 17mm

Aplicação:

MERCEDES: W204 (Classe C); W204(GLK); W207/ W211/ W212 (Classe E); W166 (Classe M); W221/ W222 (Classe S); W172 (SLK); W164/ W166 (ML) e W216 (CL) e Maybach.



AI010114

38.00€

Jogo de ferramentas para airbag



AI010097

18.80€

Chave hexagonal 1/2" especial para SCANIA e MERCEDES

Comprimento: 27mm



AI010116

48.00€

Saca velas de incandescência

Motorização: 611/ 612/ 613

Comprimento: 10mm



Ferramenta - aplicação especial por MARCAS MERCEDES

AI020113

158.00€

Jogo saca injetores common rail MB

Motorização:
OM 611/ OM 612/ OM 613



AI020184

15.00€

Chave para injetores MERCEDES BENZ

Quadra: 1/2"
Medida: 17mm
Comprimento: 119mm



AI020184B

15.00€

Chave para injetores MERCEDES BENZ

Quadra: 1/2"
Medida: 19mm
Comprimento: 119mm



AI020186

59.00€

Jogo saca bicos injectores

Modelo	Motorização
Classe C/ Classe E/ Sprinter	108CDI/ 110CDI 16V/ 112CDI 16V/ C220CDI 16V/ E200CDI 16V



AI050071S

347.00€

Jogo de 8 chaves especiais MB

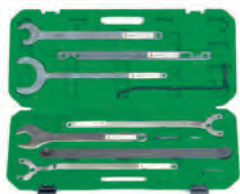

AI050085A

17.50€

Chave de filtros de 14 faces com 74mm

Nota: Se usar com uma chave caixa de 27mm, deve ser aplicada uma força máxima de 25Nm, caso sejam aplicadas forças superiores, corre-se o risco de danificar a chave filtros.

Marca:

MERCEDES/AUDI A3/ BMW E36/ CITROËN/
FIAT/ FORD/ LANCIA/ MAZDA/ NISSAN/
OPEL/ PEUGEOT/ PORSCHE/ RENAULT/
TOYOTA/ VOLKSWAGEN Golf IV



AI050200

82.00€

Jogo de 4 varetas para óleo de transmissão

Aplicacion: Mercedes Benz



AL010057

148.00€

Chave bloqueadora de cambotas MB



AN040126

225.00€

Extrator de sinoblocos eixo traseiro MB



Ferramenta - aplicação especial por MARCAS GRUPO PSA - PEUGEOT/ CITROËN

AI010136

112.00€

Kit comando motor HPI (gasolina) e HDI (diesel) PEUGEOT/ CITROËN

Marca	Modelo	Motorização	Ano
PEUGEOT	206/ 307/ 406	1.8 16V	2000-2004
	607/ 806/ 807	2.0 16V	2002-2005
	Expert		
CITROËN	C4/ C5	1.8/ 2.0HPI	2002-2005
	Xsara	2.0 16V	2002-2005
	Xsara Picasso	1.8/ 2.0 16V	2002-2005
	Evasion/ C8 Jump		

Códigos motor: 6FZ (EW7J4)/ FRN (EW10J4/L4/5)/ RLZ (EW10D)



AL010175

32.50€

Pino de fixação árvore de cames

Marca	Modelo	Motorização
CITROËN	C1/ C2/ C3/ Xsara	1.4HDI
	C3/ C4	1.6HDI
PEUGEOT	107/ 206/ 207	HDI
	307	1.4/ 1.6HDI



**Ferramenta - aplicação especial por MARCAS
GRUPO PSA - PEUGEOT/ CITROËN**
AN040100
8.30€
Chave de caixa pentagonal para travões PSA

Medida: 17mm

AL010041
177.00€
**Kit comando motor HPI (gasolina) e HDI (diesel) PEUGEOT/
CITROËN**

Marca	Modelo	Motorização	Ano	
CITROËN <i>Diesel</i>	Visa/ BX/ ZX/ Xantia/ Xsara/ Synergie/ C15/ Berlingo/ Dispatch/ C25/ Relay	1.7/ 1.8/ 1.9/ D/ TD	1984-2002	
	Saxo/ AX/ Xsara	1.5D	1994-2007	
	Xsara/ Berlingo/ Dispatch 1.9D		1998-2007	
	Xsara/ Xsara Picasso/ Xantia/ C5/ Synergie/ Berlingo/ Dispatch/ Relay 2.0HDI		1998-2007	
	C4	2.0HDI	2004-2008	
	C5	2.2HDI	2000-2004	
	C8	2.0/ 2.2/ HDI	2002-2007	
	Relay	2.5D/ TurboD	1994-2002	
	XM/ Xantia/ Dispatch/ Synergie/ Evasion	2.1D/ 2.2D/ TD	1994-2002	
	CITROËN <i>Gasolina</i>	AX/ Xsara/ AX GTi/ Saxo/ ZX/ Berlingo	1.0/ 1.1/ 1.4/ 1.6	1994-2004
		C2/ C3/ C3 Pluriel/ Berlingo	1.0/ 1.1/ 1.4	2002-2007
		Saxo/ Xsara	1.6 16V	1997-2006
		C2/ C3 Pluriel/ C4	1.6	1997-2006
		Xsara/ Xantia	1.8 16V	2002-2008
		ZX/ Xsara	2.0 16V	1996-2000
		Synergie/ Evasion/ Relay/ Jumper	2.0 Turbo	1994-2002
		Xsara	2.0 16V	2000-2004
Xsara/ C5/ Xsara Picasso		2.0HPI/ 2.0 16V/ 1.8	1999-2002	
Xsara/ C5/ Xsara Picasso		2.0HPI/ 2.0 16V/ 1.8	2002-2008	
PEUGEOT <i>Diesel</i>		205/ 305/ 405/ Partner/ 306/ 309 Talbot Horizon/ Solara Express	1.8/ 1.9/ D/ TD	1982-2001
		206/ 307	1.4 HDi	2001-2008
		206/ 306/ Express/ Partner	1.9D	1998-2007
	206/ 306/ 307/ 406/ 806/ 807	2.0HDI/ 2.0HDI 16V	1997-2007	
	307/ 307 CC/ 407	2.0HDI	2003-2008	
	406/ 607	2.2HDI	2002-2007	
	406/ 806/ Expert/ Boxer	1.9D/ TD	1994-2002	
	406/ 605/ 806	2.1D Turbo	1994-2002	
	PEUGEOT <i>Gasolina</i>	106/ 205/ 306/ 307/ 405/ Partner	1.0/ 1.1/ 1.4/ 1.6	1993-2008
		206	1.1/ 1.4/ 1.6	1998-2008
		205/ 309/ 306/ 405/ 806/ 605/ 406/ Partner/ Boxer	1.6/ 1.9/ 1.8/ 2.0	1989-2002
		206/ 307	1.6 16V	2000-2008
		306/ 407	1.8 16V	1999-2002
		206/ 307/ 406/ 406 Coupe/ 607/ 806	2.0 16V	1998-2000
		306/ 406	1.8 16V	1995-1998
306/ 406		2.0 16V	1994-2001	
306/ 406		1.6/ 2.0 Turbo	1994-2001	
406		1.8 16V	2000-2004	
406/ 406 Coupe/ 607		2.2 16V	1998-2008	
807		2.0 16V	2002-2005	

RENAULT, NISSAN e DACIA
AL010038
20.00€
Kit comando de motor RENAULT/ NISSAN

Marca	Modelo	Motorização
RENAULT	Modus/ Laguna/ Kangoo/ Clio	1.5dCI/ 1.9dCI
NISSAN	Almera/ Micra	1.5dCI

AL010190
64.00€
Kit comando de motor

Marca	Modelo	Motorização	Ano
RENAULT	Clio	1.2/ 1.4/ 1.6	
	Clio Sport	2.0	
	Espace	2.0	
	Scenic	1.4/ 1.6/ 1.8/ 2.0	
	Scenic II	1.4/ 1.6/ 2.0	
	Grand Scenic II	1.4/ 1.6	
	Laguna	1.8/ 2.0	
	Laguna II	2.0	
	Megane	1.4/ 1.6/ 1.8/ 2.0	
	Megane II	1.4/ 1.6/ 2.0	
DACIA	Logan	1.4/ 1.6	
	Sandero	1.4/ 1.6	
NISSAN	Micra		2003>2008
	Almera		2002>2006
	Note		2006>2008
	Qashqai		2007>2008
<i>Diesel</i>		1.2/ 1.4/ 1.6/ 1.8 (8v-16v)/ 2.0IDE/ 2.0Turbo	

Códigos motor: D4F/ K4J/ K4M/ K7M/ K9K/ F4P/ F3R/ F4R/ F5R/ F4RT



Ferramenta - aplicação especial por MARCAS GRUPO VAS - AUDI, VOLKSWAGEN, SKODA, SEAT e PORSCHE
AI010069 24.00€
Ferramenta de bloqueio da cambota VOLKSWAGEN

Para bloquear a cambota quando se quiser substituir a correia ou outros componentes.

Marca	Modelo	Motorização
AUDI	A4/ A6	
SEAT	Alhambra/ Altea/ Arosa/ Cordoba/ Ibiza/ Leon/ Toledo	
VOLKSWAGEN	Bora/ Golf/ Lupo/ Passat/ Polo	TDI's

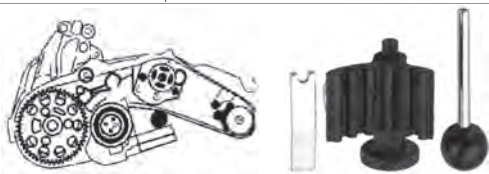
AI010070 29.80€
Ferramenta de bloqueio da cambota (VAS)

Marca	Modelo	Motorização
AUDI	A2	1.4TDI
	A3	1.9TDI/ 2.0TDI
	A4	1.6TDI/ 1.9TDI/ 2.0TDI
	A6	1.9TDI
SEAT	Altea	1.9SDI/ TDI
	Leon	1.9/ 2.0TDI
	Toledo	1.9SDI/ TDI
VOLKSWAGEN	Beetle/ Bora/ Sharan	1.9TDI
	Fox/ Lupo	1.4TDI
	Golf	1.9/ 2.0TDI
	Polo	1.4/ 1.9TDI

AI020127 45.00€
Ferramenta para tirar injetores

Aplicação: Grupo VAS (motores TDI)

AI020154 293.00€
Instalador vedante da cambota VOLKSWAGEN

Marca	Modelo	Ano
AUDI	A3	2004>
	A4	
SKODA	Octavia2/ Roomster/ Fabia	
VOLKSWAGEN	Golf	2004>
	Transporter T5/ Caddy/ Touran	2004>

AI020184A 14.50€
Chave para injetores BMW e VOLKSWAGEN

 Quadra: 1/2"
 Medida: 14mm
 Comprimento: 119mm

AI050079 12.60€
Chave bujão caixa de velocidades e transmissões 1/2"

 Marcas: AUDI e VOLKSWAGEN
 Chave estriada XZN Tamperproof M16

AI050201 35.50€
Varetas para óleo

Aplicação: Audi/Volkswagen

AL010029 31.50€
Ferramenta de alinhamento dupla árvore cames motores gasolina

Marca	Modelo	Motorização
AUDI	A2	1.4/ 1.6
SEAT	Arosa/ Ibiza/ Cordoba/ Toledo/ Leon/ Inca	1.4/ 1.6
	SKODA	Fabia/ Octavia
VOLKSWAGEN	Lupo/ Polo/ Golf/ Bora/ Beetle/ Caddy	1.4/ 1.6

AL010053A 58.20€
Kit comando do motor

Marca	Modelo	Motorização	Ano
VOLKSWAGEN	Polo	1.2 6V/ 12V	2002>
SEAT	Ibiza	1.2 6V	2002>
SKODA	Fábia	1.2 6V/ 12V	2003>

AL010072 8.30€
Kit comando do motor

Marca	Modelo
AUDI	A4/ S3/ A6/ TT
SEAT	Ibiza/ Cordoba/ Leon/ Toledo/ Alhambra
SKODA	Octavia
VOLKSWAGEN	Golf/ Bora/ Beetle/ Passat



AL010087
198.00€
Kit comando de motor AUDI

Marca	Modelo	Motorização
AUDI	A4	3,2FSI
	A6	2,4
	A6	2,4quattro
	A6	3,2FSI A)
	A8	3,2FSI A

AL010088
79.00€
Kit comando de motor a gasolina

Marca	Modelo	Motorização
AUDI	A3	1.4L/ 1.6 FSI
SKODA	Octavia	
VOLKSWAGEN	Polo/ Golf/ Golf Plus/ Jetta/ Passat/ Touran	

AN010202
28.00€
Chave de impacto especial XZN 3/4" para cubos rodas AUDI/ VOLKSWAGEN

 Medida: M18
 Comprimento: 105mm

AN010202B
12.50€
Chave de impacto XZN 1/2" AUDI/ VOLKSWAGEN

Especialmente concebida para o aperto dos parafusos que fixam o eixo traseiro

 Medida: M18
 Comprimento: 78mm

AI010108
24.00€
Ajustador do rolete tensionador

Marca	Modelo
AUDI	A4/ A6/ Cabrio
SEAT	Ibiza
SKODA	Superb
VOLKSWAGEN	Polo/ EOS/ Passat

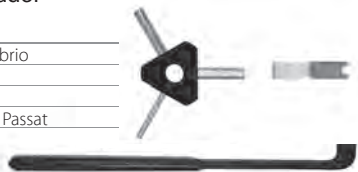
AL010291
119.00€
Kit comando motores VAS

AI010110
220.00€
Jogo sincronismo motor - grupo VAS

Marca	Modelo	Motorização	Ano
AUDI	A3	1.6FSI	2003-2006
	A3/ S3	1.8Turbo	1996-2003
	A4/ A6	1.8Turbo	1994-2006
	Cabriolet		1997-2000
	TT	1.8Turbo	1998-2006
SEAT	Ibiza	1.8Turbo	1999-2002
	Cordoba	1.8Turbo	
	Leon	1.8Turbo	1999-2005
	Toledo	1.8Turbo	1999-2005
SKODA	Octavia	1.8Turbo	1996-2005
	Octavia	1.8Turbo	2000-2005
	20V RS		
VOLKSWAGEN	Golf	1.6FSI	
	Touran	1.6FSI	
	Beetle	1.8Turbo	1999-2006
	Golf/ Bora	1.8Turbo	1997-2005

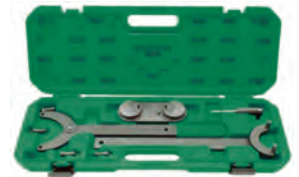
AL010202
6.50€
Pino fixação cambota - grupo VAS

Esta chave é equivalente à ferramenta especial VAG T10340

Marca	Modelo	Motorização
VOLKSWAGEN	Polo/ Golf/ Golf VI Cabrio/ Golf Plus/ Golf Variant/ Touran/ EOS/ Passat/ Jetta/ Scirocco/ Beetle/ Sharan/ Tiguan/ Caddy/ Caddy Maxi/ Fox	1.4/1.6TSI/FSI
AUDI	A3	1.4/1.6TSI/FSI
SEAT	Cordoba/ Ibiza	1.4/1.6TSI/FSI
SKODA	Fabia/ Roomster	1.4/1.6TSI/FSI



Códigos de motor: AWY/ AXU/ AZQ/ BAG/ BBM/ BKG/ BLF/ BLG/ BLN/ BLP/ BMD/ BME/ BMY/ BTS/ BWK/ BZG/ CAVA/ CAVB/ CAVC/ CAVD/ CAXA/ CEVA/ CGPA/ CGPB/ CHFA

AL010203
6.40€
Pino de fixação da cambota - grupo VAS

Esta chave é equivalente à ferramenta especial VAG T40069

Marca	Motorização
AUDI/ SEAT/ SKODA/ VOLKSWAGEN	2.0/ 2.4/ 3.2FSI/ 3.0 V6 TDI/ 4.2 V8 TDI/ 2.8/ 1.4/ 1.6 TSI/FSI

Código de motor: BGP/ BGQ/ CBUA/ CBTA/ BPR/ BPS

AL010225
78.00€
Kit comando motores VOLKSWAGEN

Modelo	Motorização	Ano
Transporter	2.4D T4	1995>2003
Código de motor: AAB/ AJA		
Transporter	2.5TDI	1995>2003
Código de motor: ACV/ AHY/ AJT/ AUF/ AXG/ AXL/ AYC		
Crafter	2.5TDI	2006 >2012
Código de motor: BJJ/ BJK/ BJL/ BJM		



ME010001 428.00€

Jogo de guias para montagem de retentores suspensão

Composição:

Ref.	Compr. (mm)
329-01	449/50
329-02	45
329-03	43
329-04	41
329-05	39
329-06	35/36
329-07	48
329-08	54
329-09	46/47



ME010007 34.00€

Chave de montagem/ desmontagem da forqueta invertida

Marca: Kayaba/ Showa



ME010009 11.00€

Saca pip de válvula de ar



ME010010 19.50€

Jogo de guias para casquilhos suspensão

Composição/ medidas (mm):
12,5; 14; 16 e 18



ME010012 32.00€

Guia para montagem/ desmontagem forqueta invertida



ME020001 39.00€

Removedor do rolamento da coluna da direção

Abertura: 30-68mm



ME020002 61.00€

Ferramenta para instalação rolamento da direção

Diâmetro da haste: 26, 30, 31 e 35mm



ME020003 310.00€

Saca do rolamento da haste da mesa da direção

Medidas (mm): 44, 48 e 51mm



ME020005 90.00€

Guia para instalação do rolamento da direção

Diâmetro da haste: 26, 30, 31 e 35mm



ME020006 250.00€

Dispositivo de instalação das caixas dos rolamentos cônicos na coluna de direção

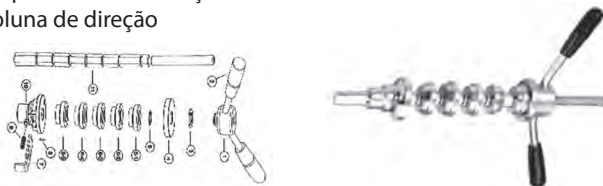

MG010001 35.00€

Saca cubo embraiagem/ polie alternador



MG01000

Chave fêmea da embraiagem

Ref.	Medida (mm)	Pinos	Preço
MG010002	34x59	2	20.00€
MG010003	41x59	2	20.00€
MG010004	39x72	2	23.00€
MG010005	46x72	2	23.00€
MG010006	46	3	23.00€



MG010008 30.00€

Ferramenta para comprimir embraiagem

Para motores 50 a 250cc
com polie de ø125 a 155mm



MG010009 39.00€

Ferramenta para comprimir embraiagem

Para motores 50 a 250cc
com polie de ø125 a 155mm



MG020001

34.00€

Corta corrente

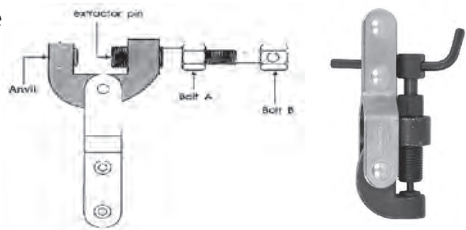

MG020003

75.00€

Corta/ rebitador da corrente



MG020004

12.50€

Alicate para o elo de fecho

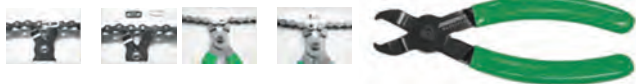

MG020006

15.00€

Ferramenta de fecho da corrente (transmissão ou distribuição)



MG020007

55.00€

Kit limpeza da corrente



MG020008

14.00€

Escova limpa correntes



MI010014

23.00€

Saca válvulas do motor



MI010016

47.00€

Removedor/ instalador do pino do piston

Medidas (mm):

Pistões: 40 a 100
Pinos: 12 a 25



MI010017

24.00€

Instalador dos segmentos do pistão



MI010018

22.60€

Protetor em alumínio para torno

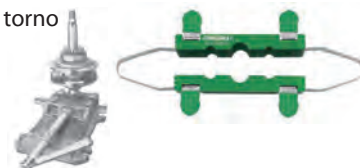

MI010019

193.00€

Ferramenta de auxílio para fecho do motor

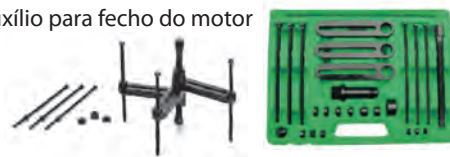

MI010020

27.00€

Ferramenta de bloqueio embraiagem/ volante scooter



MI010021

23.00€

Saca para volante magnético



MI020001

12.30€

Chaves para jets 6 e 8mm



MI020002

19.00€

Jogo de chaves para carburadores FCR



MI020004

25.80€

Medidor do nível da altura da bóia do carburador



MN020004

8.00€

Protetor de jantes



MN020005

5.00€

Descolador de pneus



MT010001

8.90€

Oleador de cabos

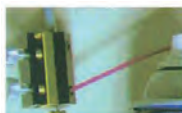

MT010002

46.50€

Ferramenta de furação da fêmea e parafuso de segurança



MT010003

132.00€

Cavalete para roda traseira



MT010004

130.00€

Suporte central universal



MT010005

23.00€

Chave ajustável bloqueio de embraiagem



MT010006

25.50€

Chave ajustável bloqueio de embraiagem



MT010007

38.00€

EZ-ROLL (sistema rotação roda traseira)



MT010008

8.90€

Gancho para molas



CHAPEIRO

AB010001

48.00€

Kit de 10 peças para montagem de vidros



AB010002

86.00€

Kit de remoção para vidros parabrisas



AB010002-A

16.60€

Bobine de arame para remoção de vidros - 15m



AB010017

20.00€

Faca parabrisas



AB0100

Lâmina em aço para faca parabrisas

Ref.	Medida	Preço
AB010018	3/4"	1.90€
AB010019	1"	1.90€
AB010020	1-1/2"	1.95€



AB010026S

36.00€

Removedor de frisos e plásticos



AB010041 40.00€

Jogo de 12 chaves para remoção de painéis



AB010043 57.00€

Espelho auxiliar para reparação de mossas



AB020002 21.00€

Ventosa simples para vidros



AB020003 50.00€

Ventosa dupla para vidros



AB020009 47.00€

Ventosa dupla articulada para vidros

Estrutura em alumínio
Ventosas: ø115mm



AB020010 67.00€

Ventosa tripla para vidros

Estrutura em alumínio
Ventosas: ø123mm
Capacidade: 35 kg/100 kg



AB020015 7.70€

Jogo de ventosas para colocar vidros



Chapeiro

AB020019 40.00€

Jogo de 6 ventosas

Para auxílio durante a colagem de frisos, vidros, etc



AB030001 6.60€

Jogo de 4 espátulas de 25 a 100mm



AB030014 10.60€

Ferramenta para colocação borrachas nos vidros



AB030028 4.50€

Chave para cavilhas e encaixes plásticos



AB030041 5.10€

Chave para cavilhas e encaixes plásticos



AB030043 4.70€

Chave para cavilhas e encaixes plásticos

Encaixe em "V"



AB030046 4.70€

Chave para cavilhas e encaixes plásticos

Encaixe de 8mm



AB030047 3.50€

Chave para cavilhas e encaixes plásticos

Encaixe de 6mm



AB030048 6.60€

Chave para cavilhas e encaixes plásticos



AB030060 47.00€

Jogo de 2 alicates para molas plásticas



AB030068A 30.50€

Alavanca de chapeiro

Medida: 380mm



AB030068C 38.80€

Alavanca de chapeiro

Medida: 900mm



AB030068D 35.00€

Alavanca de chapeiro

Medida: 750mm



AB030068F 24.50€

Alavanca de chapeiro

Medida: 450mm



AB030069A 25.00€

Cunha de chapeiro

Medida: 125mm



AB030069B 34.50€

Cunha de chapeiro

Medida: 137mm



AB030069E 8.60€

Cunha de chapeiro

Medida: 48mm



AB030094J 10.00€

Cunha de chapeiro

Medida: 84,7mm



AB030070B 25.00€

Encontrador de dupla face



AB030070C 21.90€

Encontrador curvo



AB030070D 33.80€

Encontrador tipo vírgula



AB030089 141.00€

Jogo de 7 encontradores para alumínio em polietileno de alta densidade



AB030100 62.00€

Martelo para alumínio com acessórios



AB030071 39.00€

Martelo de cabeça redonda serrilhada



M10110 24.50€

Martelo de cabeça plana redonda e pena pontiaguda



M10210A 20.50€

Martelo de cabeça plana redonda e pena curva



M10210B 20.50€

Martelo de cabeça plana redonda e pena direita



M10410A 26.50€

Martelo de puxar com cabeça redonda plana e quadrada rendilhada picotada



M10410B 26.50€

Martelo de puxar com cabeça redonda plana e quadrada rendilhada normal



AG010023

11.10€

Base para lixa em plástico ABS
Dimensões: 106x212mm



AG010024

32.00€

Armação flexível para lixa de chapeiro
Para limas de 355mm



AG010024

Lima para AG010024



Ref.	Serra	Compr.	Preço
AG010024-1	9	14"/355mm	31.00€
AG010024-2	12	14"/355mm	36.50€

AG010030A

163.00€

Jogo de martelos e encontradores



AG010185

108.00€

Alicate de rebordear

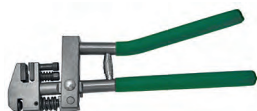

AG010055

25.00€

Desandador de percussão com acessórios



AG010055-B

3.20€

Jogo de 4 bits para AG010055/AG010138

Composição:

Fenda: 8 e 10mm
Philips: PH2 e PH3



AE310003

105.00€

Jogo de tira mossas



Chapeiro

AE330004

76.00€

Pinça de chapeiro uni-direcional
Capacidade: 3t



AE330005

77.00€

Pinça de chapeiro bi-direcional
Capacidade: 2t (transversalmente)
3t (longitudinalmente)



AE330008

61.00€

Pinça de chapeiro bi-direcional
Capacidade: 2t (puxar cruzado)
3t (puxar direito)



AE330009

135.00€

Pinça de chapeiro tipo alicate uni-direcional
Capacidade: 3t



AE330013

133.00€

Pinça de chapeiro bi-direcional
Capacidade: 3t (transversalmente)
5t (longitudinalmente)



AE330015

241.00€

Pinça de chapeiro bi-direcional de 2 pontos
Capacidade: 5t



AE330016

46.50€

Gancho para união de corrente
Capacidade: 6t



AE330030

88.00€

Ponto fixo de puxar
Capacidade: 5t



AE330034

200.00€

Pinça de chapeiro de posição variável até 90°
Capacidade: 5t



Chapeiro

AE330035

95.00€

Pinça de chapeiro
Capacidade: 5t



AG010138

23.20€

Desandador de percussão com 13 bits de 36mm

Phillips: PH1; PH2; PH3 e PH4
Fenda: 5; 6; 8; 10 e 12mm
Hexagonais: 4; 5; 6 e 8mm



AG010138-B

8.10€

Jogo de 13 bits para AG010138/AG010055



AG010140

12.30€

Encontrador múltiplo



AG010141

66.50€

Punho para chapeiro com pontas intermutáveis



AG010142

60.00€

Martelo para chapeiro com pontas intermutáveis



AG010143

67.50€

Punho com punções e escopros intermutáveis



AL010113 33.00€

Chave de 1/2" para rodar cambota

Aplicação: SCANIA

AL010114 46.00€

Chave de 1/2" para alinhar cambota

Aplicação:

Marca Motorização

MERCEDES 6.8/ 10 cilindros

MAN 12 cilindros

AL010116 57.00€

Chave de 11 dentes para alinhar cambota

Medida: Parafuso hexagonal de 24mm

 Aplicação: DAF CF65/ CF75/ CF85/
F65/ F75/ F85/ F95/ XF95

AL010117 31.50€

Chave de 1/2" para alinhar cambota

Aplicação: DAF XF105 euro

AN010187 157.00€

Alicate para cintas de travões

Aplicação: VOLVO

AI010153 19.50€

Chave sensor de posição com 8 faces de 1/2"

Não utilizar com máquinas pneumáticas

Medida: 27mm

Comprimento: 60mm

Aplicação: MERCEDES Actros/ série SK/ MAN/ SCANIA

AI020164 31.50€

Chave para válvula eletromagnética com 8 faces de 3/4"

Medida: 38mm

Comprimento: 100mm

Aplicação: SCANIA

AI040245 26.00€

Chave para rolamentos da cambota de 3/4"

Medida: E28 - Torx

Comprimento: 90mm

Aplicação: SCANIA

AI050135 132.00€

Jogo de chaves de copo para filtros - pesados

Composição:

Chave 6 faces 36mm

Chave 15 faces 74mm

Chave 15 faces 106mm

Chave 15 faces 107mm

Chave 15 faces 108mm

Chave 18 faces 108mm

Chave 18 faces 135mm

Chave de cinta Ø 160mm

Chave 21mm

AI050172 155.00€

Chave de filtros ajustável de 1/2"

Medida: 104-150mm

AN010235 62.00€

Chave de 3/4" para instalação/ remoção de fêmea embraiagem

Diâmetro interno: 64mm

Diâmetro externo: 79mm

Comprimento: 78mm

Espigões: 7mm

Aplicação: SCANIA

AN010237 125.00€

Extrator para articulações tirante de travões

Haldex

AN040062 34.50€

Chave montagem/ desmontagem de injetores

Aplicação: SCANIA/ MERCEDES/ MAN

AN040066 182.00€

Saca rótulas

Medida: 39mm

Aplicação: SCANIA/ MERCEDES/ MAN/ HINO

AN040105 165.00€

Chave para roda traseira com 8 faces de 1"

Medida: 100mm

Aplicação: SCANIA

AN040200 114.00€

Chave cubo para roda dianteira de 1"

Medida: 80mm

Aplicação: SCANIA



AG01016

Chave de rodas dupla



Ref.	Medida (mm)	Dimensão (mm)	Preço
AG010167	24x27	3/4" x 600	44.00€
AG010168	30x32	3/4" x 600	50.00€
AG010169	32x33	3/4" x 600	52.00€

AI050110

Chave de filtros de corrente

Comprimento da corrente: 520mm
Filtros: 60-165mm



57.00€

AB030076

Molas de plástico

Ref.	Quant. Embl.	Preço
AB030076-01	300	19.50€
AB030076-02	300	19.50€
AB030076-03	200	19.50€
AB030076-05	150	17.00€
AB030076-06	150	17.00€
AB030076-07	200	19.40€
AB030076-11	200	19.40€
AB030076-13	200	19.40€
AB030076-14	100	20.80€
AB030076-15	100	21.00€
AB030076-17	100	20.80€
AB030076-18	200	19.50€
AB030076-20	200	20.00€
AB030076-21	100	23.00€
AB030076-24	100	22.00€
AB030076-26	100	24.70€
AB030076-27	100	24.90€
AB030076-28	100	24.90€
AB030076-30	100	21.00€
AB030076-32	100	20.90€
AB030076-34	200	36.00€



AN04005

Chave para remoção da tampa do cubo da roda traseira



Ref.	Medida (mm)	Preço
AN040055	111	152.00€
AN040056	120	156.00€

AB030076-00

89.00€

Jogo de 21 tipos de molas com 20 peças de cada
Caixa plástica



AI020158

106.00€

Jogo de 150 anilhas de cobre para injetores com 15 medidas

Composição:

13,85x7,3x1,4; 14,60x7,5x1,3; 14,60x7,5x3,0; 15x7x2;
15x7,5x1; 15x7,5x1,5; 15x7,5x2; 15x7,5x2,5; 15x7,5x3;
15,5x7,5x2; 16x7,5x1,5; 16x7,5x1,7; 16x7,5x2; 16x7,4x2
e 20x9,4x0,9



AR030022

74.00€

Jogo de 530 terminais auto com 18 tipos





JONNESWAY®

Ferramenta Pneumática



**Ferramenta
pneumática**

**Acessórios
para redes de
ar comprimido**



JAI-1024

190.00€

Máquina compacta de impacto de 1/2"

Caraterísticas:

Rotações em vazio:	10 000rpm
Torque trabalho:	510Nm
Torque máximo:	570Nm
Comprimento:	99mm
Peso:	1 400g
Consumo ar:	127l/min
Pressão de funcionamento:	6,2bar
Ruído:	97dB



JAI-1024-RK

11.00€

Kit de reparação para JAI-1024

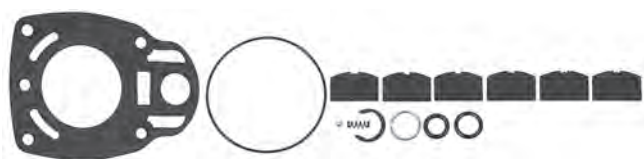

JAI-1124

197.00€

Máquina compacta de impacto de 1/2"

Máquina ultra leve em compósito com mecanismo de 2 percutores e 3 velocidades de aperto e 1 velocidade de desaperto (potência máxima). Cobertura frontal em liga alumínio resistente.

Caraterísticas:

Rotações em vazio:	9 500rpm
Torque trabalho:	560Nm
Torque máximo:	620Nm
Comprimento:	112mm
Peso:	1 150g
Consumo ar:	136l/min
Pressão de funcionamento:	6,2bar
Ruído:	99,9dB



BREAKAWAY

torque 1 100Nm

JAI-1124-RK

13.00€

Kit de reparação para JAI-1124



JAI-1114

203.00€

Máquina de impacto de 1/2"

Máquina em compósito preparada para trabalho intensivo com mecanismo de 2 percutores.

Caraterísticas:

Rotações em vazio:	9 500rpm
Torque trabalho:	880Nm
Torque máximo:	1 356Nm
Comprimento:	190mm
Peso:	2 300g
Consumo ar:	207l/min
Pressão de funcionamento:	6,2bar
Ruído:	99,2dB



JAI-1114K

270.00€

Máquina pneumática de impacto de 1/2" com kit de chaves

Máquina em compósito preparada com mecanismo de 2 percutores.

Caraterísticas:

Rotações em vazio:	9 500rpm
Torque trabalho:	880Nm
Torque máximo:	1 356Nm
Comprimento:	190mm
Peso:	2 300g
Interior mangueira:	10mmø
Consumo ar:	207l/min
Ruído:	99,2dB



Acessórios:

- 10 Chaves impacto de 1/2": 9; 10; 11; 13; 17; 19; 22; 24 e 27mm
- 1 Extensão de 125mm
- 1 Kit de manutenção

JAI-1114-RK

15.50€

Kit de reparação para JAI-1114

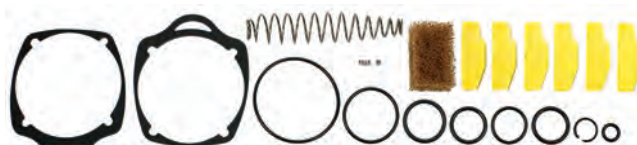

JAI-1524

152.00€

Máquina pneumática de impacto de 1/2"

Máquina em compósito para trabalho intensivo preparada com mecanismo de 2 percutores.

Caraterísticas:

Rotações em vazio:	8 500rpm
Torque trabalho:	840Nm
Torque máximo:	1 080Nm
Comprimento:	190mm
Peso:	2 500g
Interior mangueira:	10mmø
Consumo ar:	125l/min
Ruído:	104,8dB
Posições de aperto:	3
Posições de desaperto:	1



JAI-1524-RK

10.00€

Kit de reparação para JAI-1524



JAI-0954

248.00€

Máquina de impacto de 1/2"

Máquina em compósito preparada com mecanismo de 2 percutores (Twin Hammer).

Caraterísticas:

Rotações em vazio:	8 500rpm
Torque trabalho:	880Nm
Torque máximo:	1 356Nm
Comprimento:	181mm
Peso:	1 900g



JAI-0954-RK

21.00€

Kit de reparação para JAI-0954



JAI-1232K

175.00€

Máquina para remoção de velas de incandescência de 1/4" com kit de chaves

Máquina com comutador de direção incorporado no botão de acionamento, permitindo efetuar a mudança de direção só com uma mão. 4 Posições reguláveis para 20; 30; 40 e 45Nm

Caraterísticas:

Rotações em vazio:	11 000rpm
Torque:	20-45Nm
Comprimento:	180mm
Peso:	800g
Consumo ar:	150l/min
Pressão de funcionamento:	6,2bar
Ruído:	102dB

Acessórios:

Chaves caixa longas: 8; 9; 10; 11 e 12mm
Cardan
Extensão



JAI-1232-RK

13.80€

Kit de reparação para JAI-1232



JAI-1054

237.00€

Máquina de impacto de 1/2"

Máquina para trabalho intensivo com mecanismo de 2 percutores.

Caraterísticas:

Rotações em vazio:	8 000rpm
Torque trabalho:	780Nm
Torque máximo:	920Nm
Comprimento:	186mm
Peso:	2 560g
Interior mangueira:	13mmø
Consumo ar:	119l/min
Ruído:	90dB



JAI-1054-RK

24.50€

Kit de reparação para JAI-1054



JAI-1513

248.00€

Máquina pneumática de impacto angular de 3/8"

Caraterísticas:

Rotações em vazio:	6 500rpm
Torque trabalho:	339Nm
Torque máximo:	380Nm
Comprimento:	248mm
Peso:	1 350g
Interior mangueira:	10mmø
Consumo ar:	119l/min
Ruído:	105dB



JAI-1513-RK

21.00€

Kit de reparação para JAI-1513



JAI-1514

247.00€

Máquina pneumática de impacto angular de 1/2"

Caraterísticas:

Rotações em vazio:	6 500rpm
Torque trabalho:	407Nm
Torque máximo:	460Nm
Comprimento:	248mm
Peso:	1 400g
Interior mangueira:	10mmø
Consumo ar:	119l/min
Ruído:	105dB



JAI-1514-RK

21.50€

Kit de reparação para JAI-1514

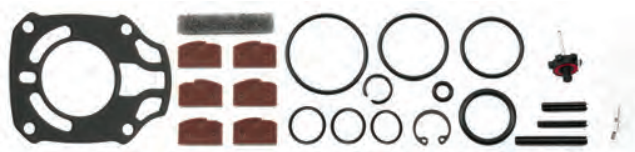

JAI-0926-RK

42.50€

Kit de reparação para JAI-0926



JAI-0936

680.00€

Máquina de impacto de 3/4"

Máquina em compósito preparada para trabalho intensivo com mecanismo de 2 percutores.

Caraterísticas:

Rotações em vazio:	6 500rpm
Torque trabalho:	1 620Nm
Torque máximo:	2 025Nm
Comprimento:	225mm
Peso:	1 940g
Interior mangueira:	13mmø
Consumo ar:	190l/min
Ruído:	90,5dB



JAI-0936-RK

66.00€

Kit de reparação para JAI-0936



JAI-6212K

470.00€

Máquina de impacto de 3/4" com kit de chaves

Máquina com mecanismo pin clutch.

Caraterísticas:

Rotações em vazio:	4 800rpm
Torque máximo:	1 086Nm
Peso:	4 900g
Interior mangueira:	13mmø

Acessórios:



Chaves: 26-38mm
Kit manutenção
Mala



JAI-6212-RK1

21.00€

Kit de reparação para JAI-6212

JAI-6211

420.00€

Máquina de impacto de 3/4" (19mm)

Máquina com mecanismo de 2 percutores.

Caraterísticas:

Rotações em vazio:	6 500rpm
Torque máximo:	1 016Nm
Peso:	4 550g
Interior mangueira:	13mmø



JAI-6211-RK

36.00€

Kit de reparação para JAI-6211



JAI-1206L

900.00€

Máquina de impacto de 3/4"

Máquina para trabalho intensivo com veio longo e mecanismo de 2 percutores.

Caraterísticas:

Rotações em vazio:	5 500rpm
Torque trabalho:	2 100Nm
Torque máximo:	2 300Nm
Comprimento:	465mm
Peso:	6 400g
Interior mangueira:	19mmø
Consumo ar:	212l/min
Ruído:	106dB

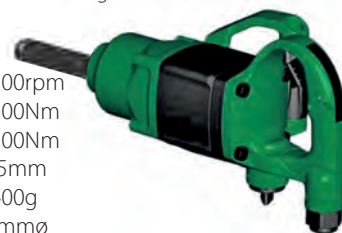

JAI-1206L-RK

61.00€

Kit de reparação para JAI-1206



JAI-0938

760.00€

Máquina de impacto de 1"

Máquina em compósito para trabalho intensivo com mecanismo de 2 percutores.

Caraterísticas:

Rotações em vazio:	6 500rpm
Torque trabalho:	1 740Nm
Torque máximo:	2 150Nm
Comprimento:	230mm
Peso:	4 100g
Consumo ar:	190l/min
Pressão de funcionamento:	6,2bar
Ruído:	190,5dB



JAI-0938-RK

63.00€

Kit de reparação para JAI-0938



JAI-1138

775.00€

Máquina de impacto de 1"

Máquina de veio curto com mecanismo de 2 percutores.

Caraterísticas:

Rotações em vazio:	5 000rpm
Torque trabalho:	2 430Nm
Torque máximo:	2 712Nm
Comprimento:	347mm
Peso:	7 400g
Interior mangueira:	19mmø
Consumo ar:	255l/min
Ruído:	100dB



JAI-1138-RK

95.00€

Kit de reparação para JAI-1138/ JAI-1138L



JAI-1138L

810.00€

Máquina de impacto de 1"

Máquina de veio longo com mecanismo de 2 percutores.

Caraterísticas:

Rotações em vazio:	5 000rpm
Torque trabalho:	2 430Nm
Torque máximo:	2 712Nm
Comprimento:	487mm
Peso:	8 300g
Interior mangueira:	19mmø
Consumo ar:	255l/min
Ruído:	100dB



JAI-1408

1 380.00€

Máquina de impacto pesados de 1"

Máquina de veio curto.

Caraterísticas:

Rotações em vazio:	4 800rpm
Torque trabalho:	3 270Nm
Torque máximo:	3 520Nm
Comprimento:	370mm
Peso:	10 500g
Consumo ar:	450l/min
Pressão de funcionamento:	6,3bar
Ruído:	105,5dB



JAI-1408-RK

82.00€

Kit de reparação para JAI-1408/ JAI-1408L



JAI-1408L

1 420.00€

Máquina de impacto pesados de 1"

Máquina de veio longo.

Caraterísticas:

Rotações em vazio:	4 800rpm
Torque trabalho:	3 270Nm
Torque máximo:	3 520Nm
Comprimento:	570mm
Peso:	11 900g
Consumo ar:	450l/min
Pressão de funcionamento:	6,3bar
Ruído:	105,5dB



JAI-6202-RK

65.00€

Kit de reparação para JAI-6202



JAI-0501-RK

22.00€

Kit de reparação para JAI-0501



JAR-1012

92.00€

Roquete pneumático de 1/4"

Caraterísticas:

- Rotações em vazio: 230rpm
- Torque máximo: 40Nm
- Comprimento: 140mm
- Peso: 469g
- Interior mangueira: 10mmø
- Consumo ar: 338l/min



JAR-1012-RK

34.00€

Kit de reparação para JAR-1012



JAR-1013

91.00€

Roquete pneumático de 3/8"

Caraterísticas:

- Rotações em vazio: 230rpm
- Torque máximo: 40Nm
- Comprimento: 140mm
- Peso: 469g
- Interior mangueira: 10mmø
- Consumo ar: 338l/min



JAR-1013-RK

34.00€

Kit de reparação para JAR-1013



JAR-1094

118.00€

Roquete pneumático de 1/2"

Caraterísticas:

- Rotações em vazio: 170rpm
- Torque máximo: 100Nm
- Comprimento: 275mm
- Peso: 1 400g
- Interior mangueira: 10mmø
- Consumo ar: 113l/min
- Ruído: 87dB



JAR-1094-RK

37.00€

Kit de reparação para JAR-1094



JAR-6309AK

147.00€

Roquete pneumático de 1/2" com kit de chaves

Caraterísticas:

- Rotações em vazio: 170rpm
- Torque máximo: 100Nm
- Comprimento: 275mm
- Peso: 1 400g
- Interior mangueira: 10mmø



Acessórios:

- Chaves: 9; 10; 11; 13; 14; 17 e 19mm
- Extensão: 75mm
- União universal de 1/2"
- Bits e porta bits
- Mala



JAR-6309A-RK

30.00€

Kit de reparação para JAR-6309A



JAR-6310A

105.00€

Roquete pneumático de 3/8"

Caraterísticas:

- Rotações em vazio: 170rpm
- Torque máximo: 100Nm
- Comprimento: 275mm
- Peso: 1 300g
- Interior mangueira: 10mmø



JAR-6310A-RK

29.00€

Kit de reparação para JAR-6310A



JAR-6310AK

145.00€

Roquete pneumático de 3/8" com kit de chaves

Caraterísticas:
 Rotações em vazio: 170rpm
 Torque máximo: 100Nm
 Comprimento: 275mm
 Peso: 1 300g
 Interior mangueira: 10mmø



Acessórios:

Chaves: 9; 10; 11; 13; 14; 17 e 19mm
 Extensão: 75mm
 União universal de 3/8"
 Bits e porta bits
 Mala



JAR-1033

320.00€

Roquete pneumático combinado de 3/4" com kit de chaves

Caraterísticas:
 Rotações em vazio: 180rpm
 Torque máximo: 107Nm
 Comprimento: 9,5mm
 Peso: 1 400g
 Interior mangueira: 10mmø



Acessórios:

Chaves: 8 a 19mm
 Adaptadores



JAR-1033-RK

80.00€

Kit de reparação para JAR-1033A



Ferramenta pneumática

JAD-0212

118.00€

Berbequim pneumático de 1/4"

Máquina em compósito.

Caraterísticas:
 Rotações em vazio: 1 800rpm
 Potência: 2cv
 Comprimento: 199mm
 Peso: 780g
 Interior mangueira: 10mmø
 Consumo ar: 54,4l/min
 Ruído: 97dB



JAD-0212-RK

10.20€

Kit de reparação para JAD-0212

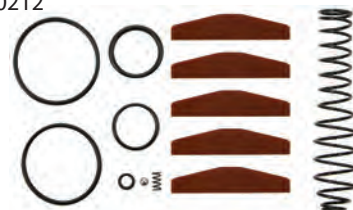

JAD-0413

120.00€

Berbequim reversível pneumático de 3/8"

Caraterísticas:
 Rotações em vazio: 1 800rpm
 Motor: 0,4cv
 Capacidade da bucha: 10mm
 Comprimento: 210mm
 Peso: 950g
 Interior mangueira: 10mmø
 Consumo ar: 99l/min
 Vibração: 3,3m/s²
 Ruído: 80dB



JAD-0413-RK

12.50€

Kit de reparação para JAD-0413



JAD-0534

329.00€

Berbequim pneumático de 1/2"

Caraterísticas:
 Potência: 0,6cv
 Rotações em vazio: 7 000rpm
 Comprimento: 240mm
 Peso: 1 400g
 Consumo de ar: 113 l/m
 Ruído em carga: 97 dB



JAD-1020

109.00€

Berbequim reversível pneumático de 1/2"

Caraterísticas:

- Rotações em vazio: 800rpm
- Capacidade da bucha: 13mm (aperto com chave)
- Comprimento: 220mm
- Peso: 1 300g
- Interior mangueira: 10mmø



JAD-1020-RK

2.50€

Kit de reparação para JAD-1020



JAD-1021

126.00€

Berbequim pneumático angular de 3/8"

Caraterísticas:

- Rotações em vazio: 1 900rpm
- Capacidade da bucha: 10mm (aperto com chave)
- Comprimento/ altura: 190x110mm
- Peso: 960g
- Interior mangueira: 10mmø
- Consumo ar: 280l/min



JAD-1021-RK

13.90€

Kit de reparação para JAD-1021



JAD-1027

140.00€

Berbequim reversível pneumático de 1/2"

Caraterísticas:

- Rotações em vazio: 800rpm
- Capacidade da bucha: 13mm (aperto sem chave)
- Comprimento: 178mm
- Peso: 1 820g
- Interior mangueira: 10mmø



JAD-1027-RK

2.40€

Kit de reparação para JAD-1027



JAD-6252A

73.00€

Berbequim pneumático de 3/8"

Caraterísticas:

- Rotações em vazio: 2 500rpm
- Capacidade da bucha: 9,5mm (aperto com chave)
- Comprimento: 228mm
- Peso: 900g
- Interior mangueira: 10mmø



JAD-6252A-RK

4.00€

Kit de reparação para JAD-6252



JAB-1017

110.00€

Aparafusadora pneumática reversível de 1/4"

Caraterísticas:

- Rotações em vazio: 1 800rpm
- Capacidade da bucha: 1/4"
- Comprimento: 190mm
- Peso: 1 100g
- Interior mangueira: 10mmø



JAB-1017-RK

2.10€

Kit de reparação para JAB-1017



JAB-1018

125.00€

Aparafusadora pneumática reversível de 1/4"

Caraterísticas:

- Rotações em vazio: 800rpm
- Capacidade da bucha: 1/4"
- Comprimento: 226mm
- Peso: 1 300g
- Interior mangueira: 10mmø



JAB-1018-RK

2.10€

Kit de reparação para JAB-1018



JAB-7003A

130.00€

Aparafusadora pneumática reversível de 1/4"

Caraterísticas:

Rotações em vazio: 1 800rpm
 Capacidade da bucha: 1/4"
 Comprimento: 254mm
 Peso: 1 140g
 Interior mangueira: 10mmø



JAB-7003A-RK

4.60€

Kit de reparação para JAB-7003A



JAD-1015K

350.00€

Máquina pneumática de descravar pontos com kit de acessórios

Caraterísticas:

Rotações em vazio: 1 800rpm
 Capacidade de furo: 8mm
 Comprimento: 254mm
 Peso: 2 100g
 Interior mangueira: 10mmø



Acessórios:



Chave hexagonal: 2,5mm
 Brocas
 Lubrificador
 Ligador: 1/4"x1/4"
 Mala

JAD-1015-RK

2.60€

Kit de reparação para JAD-1015K



JAZ-7207

85.00€

Jogo de 5 brocas para máquina descravar

Aplicável aos modelos: JAD-1015/ JAD-6246

Caraterísticas:

Brocas em HSS e cobalto
 Diâmetro: 6,5mmø



JAG-0903-MS

14.50€

Jogo de 10 buris

Aplicável aos modelos:

JAG-0903/ JAG-0906/ JAG-0913/ JAG-0923/ JAG-0925/ JAG-0955



JAG-0906RMK

91.00€

Retificadora pneumática de 1/4" com kit de acessórios

Caraterísticas:

Rotações em vazio: 22 000rpm
 Capacidade da pinça: 6mm
 Potência: 0,4Kw
 Comprimento: 175mm
 Peso: 490g
 Interior mangueira: 10mmø



Acessórios:

Buris: 6mm (1/4")
 Buris: 3mm (1/8")
 Chaves
 Redução: 3mm (1/8")
 Mala



JAG-0906R/RM-RK

8.10€

Kit de reparação para JAG-0906RMK



JAG-0913RMK

111.00€

Retificadora pneumática angular de 1/4" com kit acessórios

Caraterísticas:

Rotações em vazio: 18 000rpm
 Capacidade da pinça: 6mm
 Potência: 0,21Kw
 Comprimento: 155mm
 Peso: 490g
 Interior mangueira: 10mmø



Acessórios:

Buris: 6mm (1/4")
 Buris: 3mm (1/8")
 Chaves
 Redução: 3mm (1/8")
 Mala



JAG-0913RM-RK

5.60€

Kit de reparação para JAG-0913RMK



JAG-0923RM 54.00€

Mini retificadora pneumática de 1/4"

- Caraterísticas:
- Rotações em vazio: 25 000rpm
 - Capacidade da pinça: 6mm
 - Potência: 0,5hp
 - Comprimento: 170mm
 - Peso: 700g
 - Consumo ar: 76l/min
 - Pressão de funcionamento: 6,2bar
 - Ruído: 97dB



JAG-0923RM-RK 6.30€

Kit de reparação para JAG-0923RM



JAG-0925RM 57.00€

Retificadora pneumática de 1/4"

- Caraterísticas:
- Rotações em vazio: 22 000rpm
 - Capacidade da pinça: 6mm
 - Potência: 0,5hp
 - Comprimento: 170mm
 - Peso: 700g
 - Consumo ar: 113l/min
 - Pressão de funcionamento: 6,2bar
 - Ruído: 97dB



JAG-0925RM-RK 19.50€

Kit de reparação para JAG-0925RM



JAG-0955RM 90.00€

Retificadora pneumática de 1/4"

- Caraterísticas:
- Rotações em vazio: 22 000rpm
 - Capacidade da pinça: 6mm
 - Potência: 0,5hp
 - Comprimento: 260mm
 - Peso: 700g
 - Consumo ar: 113l/min
 - Pressão de funcionamento: 6,2bar
 - Ruído: 97dB



JAG-0955RM-RK 7.60€

Kit de reparação para JAG-0955RM



JAG-1087 157.00€

Micro retificadora pneumática

- Caraterísticas:
- Rotações em vazio: 60 000rpm
 - Bucha: 3mm
 - Interior mangueira: 10mmø
 - Peso: 220g
 - Consumo ar: 180l/min
 - Dimensões: 17x120mm



JAG-1087-RK 31.00€

Kit de reparação para JAG-1087



JAG-6638 173.00€

Rebarbadora pneumática angular de 125mm

- Caraterísticas:
- Rotações em vazio: 11 000rpm
 - Dimensão do disco: 125mm
 - Potência: 0,7Kw
 - Comprimento: 230mm
 - Peso: 1 800g
 - Interior mangueira: 10mmø
 - Vibração do punho: 6,45m/s²
 - Ruído: 86dB



JAG-6638-RK 70.00€

Kit de reparação para JAG-6638



JAG-6638-DC 2.00€

Disco de corte

Medida: 125mm

JAG-6638-DR 3.20€

Disco de rebarbar

Medida: 125mm

JAG-6639 320.00€

Rebarbadora pneumática angular de 180mm

- Caraterísticas:
- Rotações em vazio: 7 000rpm
 - Dimensão do disco: 180mm (7")
 - Potência: 1,4Kw
 - Comprimento: 343mm
 - Peso: 3 100g
 - Interior mangueira: 10mmø



JAG-6639-RK

95.00€

Kit de reparação para JAG-6639



JAG-6639-DC

3.10€

Disco de corte

Medida: 180mm

JAG-6639-DR

6.00€

Disco de rebarbar

Medida: 180mm

JAS-6505

170.00€

Lixadora de disco de 180mm

Caraterísticas:

Rotações em vazio: 4 500rpm

Dimensão do disco: 178mm

Rosca do veio: 5,8" (11UNC)

Comprimento: 406mm

Peso: 2 500g

Interior mangueira: 10mmø



JAS-6505-RK

6.30€

Kit de reparação para JAS-6505



JAS-6551

150.00€

Lixadora de disco de 180mm

Caraterísticas:

Rotações em vazio: 2 500rpm

Dimensão do disco: 178mm

Rosca do veio: 5,8" (11UNC)

Comprimento: 406mm

Peso: 2 500g

Interior mangueira: 10mmø



JAS-6551-RK

6.20€

Kit de reparação para JAS-6551



JAS-6552

145.00€

Polidora pneumática de 180mm

Caraterísticas:

Rotações em vazio: 2 500rpm

Dimensão do disco: 178mm

Peso: 2 800g

Interior mangueira: 10mmø

Consumo ar: 260l/min



JAS-6552-RK

18.00€

Kit de reparação para JAS-6552



JAS-0010

255.00€

Lixadora com base triangular em vinil

Caraterísticas:

Rotações em vazio: 9 000rpm

Dimensão da base: 93x132mm

Interior mangueira: 10mmø

Consumo ar: 260l/min



JAS-0010-RK

23.50€

Kit de reparação para JAS-0010



JAS-0010-41

21.00€

Base para lixadora JAS-0010

Dimensão da base: 93x132mm



JAS-0413

130.50€

Lixadora orbital angular

Máquina em compósito

Caraterísticas:

Rotações em vazio: 15 000rpm

Dimensão do disco: 76mm

Órbita: 3mm

Motor: 0,4cv

Comprimento: 125mm

Peso: 720g

Interior mangueira: 10mmø

Consumo ar: 99l/min

Vibração: 6,3m/s²

Ruído: 80dB



JAS-0413-RK

11.00€

Kit de reparação para JAS-0413



JAS-0423K

172.00€

Polidora angular

Máquina em compósito

Caraterísticas:

- Rotações em vazio: 2 100rpm
- Dimensão do disco: 76mm
- Motor: 0,4cv
- Comprimento: 135mm
- Peso: 770g
- Consumo ar: 99l/min
- Pressão de funcionamento: 6,2bar
- Vibração: 2,3m/s²
- Ruído: 78dB



JAS-0423-RK

24.50€

Kit de reparação para JAS-0423



JAS-0423-31

12.00€

Base em velcro para JAS-0423



JAS-1021-6HE(2.5)

222.00€

Lixadora orbital angular com base em vinil aderente com 6"

Máquina em compósito

Caraterísticas:

- Rotações em vazio: 12 000rpm
- Dimensão do disco: 150mm
- Órbita: 2,5mm
- Peso: 960g
- Interior mangueira: 10mmø
- Consumo ar: 170l/min



JAS-1021-6HE-RK

10.50€

Kit de reparação para JAS-1021-6HE



JAS-1206-6HE

350.00€

Lixadora orbital para ligação a central de aspiração com base em vinil aderente com 6"

Máquina em compósito

Caraterísticas:

- Rotações em vazio: 12 000rpm
- Dimensão do disco: 150mm
- Órbita: 5mm
- Interior mangueira: 10mmø



JAS-1206-6HE-RK

47.00€

Kit de reparação para JAS-1206-6HE



JAS-1206-6HP

53.00€

Base com velcro para lixadora JAS-1206/ JAS-1207 com 6"



JAS-1207-6HE

390.00€

Lixadora orbital com auto aspiração com base em vinil aderente com 6"

Máquina em compósito

Caraterísticas:

- Rotações em vazio: 12 000rpm
- Dimensão do disco: 150mm
- Órbita: 5mm
- Interior mangueira: 10mmø

Saco para recolha de pó



JAS-1207-6HE-RK

47.00€

Kit de reparação para JAS-1207-6HE



JAS-1207-6HE-56

29.00€

Saco em tecido para proteção do saco papel de recolha de pó para JAS-1207-6HE.



JAS-1207-6HE-57 3.60€

Saco em papel para recolha de pó para JAS-1207-6HE



JAS-1206-6HP 53.00€

Base com velcro para lixadora JAS-1206/ JAS-1207 com 6"



JAS-1031-6HE 228.00€

Lixadora orbital com base em velcro com 6"

Máquina em compósito

Caraterísticas:

Rotações em vazio: 10 000rpm
 Dimensão do disco: 150mm
 Órbita: 5mm
 Peso: 1 040g
 Interior mangueira: 10mmø



JAS-1031-6HE-RK 51.00€

Kit de reparação para JAS-1031-6HE

JAS-1031-6VE-RK 50.00€

Kit de reparação para JAS-1031-6VE

JAS-1031-6HP 25.00€

Base em velcro para lixadora JAS-1031/ JAS 6535-6HE



JAS-6531 147.00€

Lixadora retangular estreita

Máquina em compósito

Caraterísticas:

Movimentos/ minuto: 2 500
 Dimensão da base: 63,5x407mm
 Comprimento: 406mm
 Peso: 3 100g
 Interior mangueira: 10mmø
 Consumo ar: 226l/min
 Ruído: 93,3dB



JAS-6531-RK 2.80€

Kit de reparação para JAS-6531

JAS-6531-LIXA 53.00€

Rolo de lixa tela flexível

JAS-6535-5HE 205.00€

Lixadora orbital com base em velcro com 5"

Máquina em compósito

Caraterísticas:

Rotações em vazio: 10 000rpm
 Dimensão do disco: 125mm
 Órbita: 5mm
 Peso: 1 040g
 Interior mangueira: 10mmø



JAS-6535-5HE-RK 53.00€

Kit de reparação para JAS-6535-5HE

JAS-6535-5HE-47 21.00€

Base em velcro para JAS-6535-5HE



JAS-6535-5VE-RK 39.00€

Kit de reparação para JAS-6535-5VE

JAS-6535-6HE 205.00€

Lixadora orbital com base em velcro com 6"

Máquina em compósito

Caraterísticas:

Rotações em vazio: 10 000rpm
 Dimensão do disco: 150mm
 Órbita: 5mm
 Peso: 1 040g
 Interior mangueira: 10mmø



JAS-6535-6HE-RK 50.00€

Kit de reparação para JAS-6535-6HE

JAS-1031-6HP 25.00€

Base em velcro para lixadora JAS-1031/ JAS 6535-6HE



JA-6111(1.4)

114.00€

Pistola de pintura tipo gravidade

Caraterísticas:

Entrada ar: 1/4"
 Capacidade copo nylon: 600ml
 Bico standard: 1,4mm



JA-6111

Kit de bico para pistola JA-6111

Ref.	Medida (mm)	Preço
JA-6111-NS13	1.3	45.00€
JA-6111-NS17	1.7	45.00€
JA-6111-NS20	2	45.00€

JA-6111K

250.00€

Jogo de pistola de pintura tipo gravidade e acessórios

Caraterísticas:

Pistola: JA-6111
 Capacidade copo nylon: 250 e 600 ml
 Bicos: 1,7 e 2mm
 Interior mangueira: 10mmø
 Kit de limpeza
 Mala



JA-HVLP-1080GK

300.00€

Jogo de pistola de pintura HVLP e acessórios

Caraterísticas:

Pistola: JA-HVLP-1 080G
 Capacidade copo nylon: 250 e 600ml
 Bicos: 1,4; 1,7 e 2mm
 Interior mangueira: 10mmø
 Kit de limpeza
 Mala



JA-HVLP-1080GD-N1.4

62.00€

Bico de 1.4 para pistola JA-HVLP-1 080GD



JA-HVLP-300C (1.3)

185.00€

Pistola de pintura tipo gravidade

Caraterísticas:

Entrada ar: 1/4"
 Capacidade copo nylon: 600 ml
 Bico standard: 1,3mm
 Pressão ar: 2bar
 Consumo ar: 481l/min
 Peso: 545g
 Interior mangueira: 10mmø



JA-HVLP-3000-NS17

72.00€

Kit bico 1.7 para pistola de pintura

JA-HVLP-3000-NS19

72.00€

Kit bico 1.9 para pistola de pintura

JA-300C-NS13

71.00€

Bico completo 1.3 para pistola de pintura JA-HVLP3000/ JA-HVLP300C

JA-LVLP-0303W

179.00€

Pistola de pintura para tintas à base de água tipo gravidade

Caraterísticas:

Entrada ar: 1/4"
 Capacidade copo nylon: 600ml
 Bico standard: 1,3mm
 Interior mangueira: 10mmø



JA-LVLP-0303W-N

58.00€

Kit bico 1.3 para pistola de pintura

JA-LVLP-0303W-N18

58.00€

Kit bico 1.8 para pistola de pintura

JA-HVLP-6112

175.00€

Pistola de pintura tipo gravidade

Caraterísticas:

Entrada ar: 1/4"
 Capacidade copo nylon: 125ml
 Bico standard: 1mm
 Pressão ar: 3bar
 Consumo ar: 112l/min
 Peso: 240g
 Interior mangueira: 10mmø



ACC-609

23.00€

Regulador de ar 0-10 bar

JA-3806C

11.50€

 Regulador de pressão para pistola de pintura
 Aplicável à pistola JA-HVLP-6112

JA-3808A

11.00€

Separador de óleo/ água para pistolas de pintura

JA-0001RK

6.00€

Kit de reparação para pistola de pintura

AS-0026

15.50€

Kit de limpeza para pistolas de pintura com 12 peças

AS-0013A2

28.50€

 Copo de alumínio para pistola de pintura tipo gravidade
 Capacidade: 600ml

AS-001

Copo para pistola de pintura

Ref.	Capacidade (ml)	Preço
AS-0013	600	15.50€
AS-0015	125	10.00€

Ferramenta pneumática
JA-300C-28

14.60€

Copo para pistola de pintura JA-HVLP-3000

 Capacidade: 600ml
 Tampa não incluída

AS-001

Tampa para copo de pistola de pintura

Ref.	Capacidade (ml)	Preço
AS-0013C	600	4.50€
AS-0015C	250	4.50€

JA-950

79.00€

Pistola de secagem para tintas à base de água

JA-950-04

3.50€

Filtro de rede para pistola JA-950

JA-960

220.00€

 Suporte para 2 pistolas de secagem
 Não inclui as pistolas

JAS-0452

215.00€

 Lixadora de faixa larga
 Máquina em compósito

Características:

Rotações em vazio:	16 000rpm
Dimensão da base:	20x520mm
Comprimento:	430mm
Peso:	1 400g
Interior mangueira:	10mmø
Consumo ar:	113l/min
Vibração:	2,8m/s ²
Ruído:	95dB



JAS-0452-RK 39.50€

Kit de reparação para JAS-0452

JAS-6542 205.00€

Lixadora de faixa larga

Caraterísticas:

Rotações em vazio: 16 000rpm
 Dimensão da base: 20x520mm
 Comprimento: 360mm
 Peso: 1 200g
 Interior mangueira: 10mmø



JAS-6542-RK 28.00€

Kit de reparação para JAS-6542

JAS-6543 125.00€

Lixadora de faixa estreita

Caraterísticas:

Rotações em vazio: 16 000rpm
 Dimensão da base: 10x330mm
 Comprimento: 290mm
 Peso: 800g
 Interior mangueira: 10mmø



JAS-6543-RK 22.50€

Kit de reparação para JAS-6543

JAT-1020K 285.00€

Serra/ lima pneumática de baixa vibração com kit de acessórios
 Mecanismo de baixa vibração

Caraterísticas:

Oscilação por minuto: 16 000bpm
 Curso: 25mm
 Peso: 960g
 Interior mangueira: 10mmø



Acessórios:

Lâminas: T14; T18 e T24
 Limas
 Mala



JAT-1020-RK 62.00€

Kit de reparação para JAT-1020

JAT-12F

Limas para JAT-1020

Ref.	Forma	Preço
JAT-12F1	triangular	6.50€
JAT-12F2	meia cana	7.00€
JAT-12F3	redonda	6.80€
JAT-12F4	chata	6.40€



JAT-20T

Serras para JAT-1020

Ref.	Dentes	Preço
JAT-20T14	14	4.70€
JAT-20T18	18	4.70€
JAT-20T24	24	4.70€



JAT-1041 180.00€

Assentador pneumático de válvulas

Caraterísticas:

Oscilação por minuto: 3 000bpm
 Capacidade máxima: 4,5mmø
 Comprimento: 153,5mm
 Peso: 1 550g
 Interior mangueira: 10mmø
 Consumo ar: 100l/min
 Ventosas: 16; 20; 30 e 35mm



JAT-1041-16S 24.00€

Jogo de 4 ventosas para JAT-1041

Caraterísticas:

Medidas: 16; 20; 30 e 35mm



JAT-1011 160.00€

Serra pneumática de baixa vibração

Caraterísticas:

Oscilação por minuto: 11 000bpm
 Curso: 8mm
 Peso: 450g
 Interior mangueira: 10mmø
 Consumo ar: 90l/min
 Ruído: 86,8dB



JAT-1011-RK 27.50€

Kit de reparação para JAT-1011

JAT-6613 210.00€

Máquina pneumática de decapar

Características:

Diâmetro base: 105mm
 Rotações em vazio: 3.500rpm
 Entrada ar: 1/4"
 Dimensões (comp/alt): 203x106mm
 Peso: 960g
 Consumo ar: 280l/min
 Ruído: 98dB

JAT-6613-P 15.80€

Disco de borracha para JAT-6613

JAT-6613-PA 16.00€

Disco abrasivo de limpeza para JAT-6613

JAT-6613-RK 28.50€

Kit de reparação para JAT-6613

JAT-6676 133.00€

Serra pneumática

Características:

Capacidade de corte: 1,6mm (espessura aço)
 Oscilação por minuto: 10 000bpm
 Curso: 10mm
 Comprimento: 235mm
 Peso: 960g
 Interior mangueira: 10mmø

JAT-6676-RK 7.50€

Kit de reparação para JAT-6676

JAT-10T

Serras para JAT-6676 5 unidades

Ref.	Dentes	Compr. (mm)	Preço
JAT-10T18	18	75	15.50€
JAT-10T32	32	75	15.90€

JAT-6421 50.00€

Máquina de corte pneumática de discos com 3"

Características:

Rotações em vazio: 20 000rpm
 Peso: 1 040g
 Interior mangueira: 10mmø

JAT-6421-RK 2.70€

Kit de reparação para JAT-6421

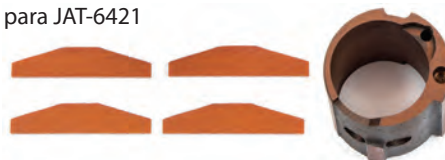
JAT-6421-33 2.10€

Disco de serra para JAT-6421

JAT-6441K 140.00€

Faca pneumática com kit de acessórios

Características:

Oscilação por minuto: 22 000bpm
 Comprimento: 120mm
 Peso: 1 200g
 Interior mangueira: 10mmø



Acessórios:

 Lâminas: 30; 35 e 57mm
 Mala

JAT-6441-RK 2.00€

Kit de reparação para JAT-6441

CF-K

Lâminas para JAT-6441K

Ref.	Compr. (mm)	Preço
CF-K-C	35	10.70€
CF-K-E	57	9.00€
CF-K-F	90	22.70€
CF-K-G	24	13.50€
CF-K-I	36	17.50€
CF-K-J	63	20.00€



JAT-6443K 180.00€

Ferramenta de corte por oscilação

Caraterísticas:

Amplitude de corte: 3mm
 Potência: 0,3cv
 Oscilação por minuto: 20 000bpm
 Comprimento: 180mm
 Peso: 700g
 Consumo de ar: 54l/m
 Ruído em carga: 95dB



Acessórios: 8 acessórios de corte

JAT-6443-RK 14.00€

Kit de reparação para JAT-6443



JAT-6443-K

Acessórios de corte para JAT-6443

Ref.	Tipo lâmina	Compr. (mm)	Preço
CF-K-E	Corte	57	9.00€
JAT-6443-K1	Corte nivelado	10	5.70€
JAT-6443-K2	Corte nivelado	20	6.50€
JAT-6443-K3	Corte nivelado	30	5.70€
JAT-6443-K4	Raspadora	51	5.70€
JAT-6443-K5	Lixadora triangular	80	7.80€
JAT-6443-K6	HSS meia lua	88	23.00€
JAT-6443-K7	Meia lua rebarbar	64	11.50€



JAT-6952 95.50€

Tesoura pneumática direita

Caraterísticas:

Oscilação por minuto: 2 300/ 2 500bpm
 Capacidade de corte: 1,2mm (espessura aço)
 Tamanho do corte: 5,5mm
 Comprimento: 255mm
 Peso: 1 000g
 Interior mangueira: 10mmø



Acessórios:

Lâminas: 30; 35 e 57mm

JAT-6952-RK 2.00€

Kit de reparação para JAT-6952

JAT-6952P 110.00€

Tesoura pneumática

Caraterísticas:

Oscilação por minuto: 2 200bpm
 Capacidade de corte: 1,2mm (espessura aço)
 Tamanho do corte: 5,5mm
 Comprimento: 215mm
 Peso: 1 200g
 Interior mangueira: 10mmø



JAT-6952P-RK 2.00€

Kit de reparação para JAT-6952P

JAT-6952P

Lâminas para JAT-6952/P

Ref.	Lâmina	Preço
JAT-6952P-37	esquerda	11.00€
JAT-6952P-39	central	13.00€
JAT-6952P-40	direita	11.00€

JAT-6943A 118.00€

Alicate pneumático de rebaixos

Caraterísticas:

Capacidade de corte: 1,4mm
 Capacidade de rebaixo: 8mm
 Quinagem: 12mm
 Comprimento: 248mm
 Peso: 1 300g
 Interior mangueira: 10mmø



JAT-6943A-RK 9.30€

Kit de reparação para JAT-6943A

JAT-6412 76.00€

Reboreadora pneumática

Caraterísticas:

Velocidade de corte: 3 200rpm
 Capacidade de corte: 1,4mm (espessura aço)
 Comprimento: 210mm
 Peso: 1 000g
 Interior mangueira: 10mmø



JAT-6412-RK 2.00€

Kit de reparação para JAT-6412

JAH-0288 119.00€

Martelo pneumático de agulhas

Caraterísticas:
 Pancadas por minuto: 5 000
 Número de agulhas: 12
 Comprimento: 290mm
 Peso: 1 200g
 Consumo ar: 90l/min
 Interior mangueira: 10mmø

JAH-0288-15 15.30€

Cinzel para JAH-0288
JAH-0288-16 7.90€

Jogo de agulhas para JAH-0288
JAH-0288-17 5.90€

Alojamento de agulhas para JAH-0288
JAH-0288-RK 25.50€

Kit de reparação para JAH-0288
JAH-308HK 188.00€

Martelo pneumático de baixa vibração

Caraterísticas:
 Encaixe hexagonal
 Curso do pistão: 64mm
 Golpes por minuto: 3 000
 Comprimento: 230mm
 Peso: 2 000g
 Consumo de ar: 170l/m



Acessórios:
 5 acessórios
 Mala

JAH-308HK-RK 7.50€

Kit de reparação para JAH-308H

JAH-6837 162.00€

Martelo burilador direito

Caraterísticas:
 Golpes por minuto: 4 600
 Encaixe: 25,4x43,5
 Comprimento: 380mm
 Peso: 2 100g
 Interior mangueira: 10mmø

JAH-6837-RK 21.00€

Kit de reparação para JAH-6837
Ferramenta pneumática
JAH-6837-5
Cinzel para JAH-6837

Ref.	Tipo	Compr. (mm)	Preço
JAH-6837-50	plano	35-175	18.50€
JAH-6837-50-2	ponteiro		18.80€

JAH-7104H

413.00€

Martelo pneumático de 1"

Caraterísticas:
 Golpes por minuto: 2 820
 Comprimento: 308mm
 Peso: 5 500g
 Consumo ar: 228l/min
 Interior mangueira: 10mmø

JAH-7104H-RK

6.50€

Kit de reparação para JAH-7104H
JAZ-01
Buril hexagonal

Ref.	Tipo	Preço
JAZ-011H	bico	23.00€
JAZ-016H	ponta	23.00€

JAT-6034

113.00€

Rebitadora pneumática

Caraterísticas:
 Capacidade: 2,4 a 4,8mm (aço+aço inox)
 Potência tração: 10 250Nm
 Curso: 16mm
 Comprimento: 308mm
 Peso: 1 500g
 Interior mangueira: 10mmø

JAT-6034-RK

26.00€

Kit de reparação para JAT-6034

JAT-6034
Bicos para rebitadora JAT-6034

Ref.	Diâmetro (mm)	Preço
JAT-6034-1A	4,8	1.25€
JAT-6034-1B	4	1.25€
JAT-6034-1C	3,2	1.25€
JAT-6034-1D	2	1.25€



JAT-6673

340.00€

Rebitadora pneumática

Caraterísticas:
 Capacidade: 2,4 a 6,4mm (aço+aço inox)
 Curso: 18mm
 Peso: 1 750g
 Consumo ar: 2,9l/ciclo
 Interior mangueira: 10mmø



JAT-6673-RK

59.50€

Kit de reparação para JAT-6673

JAT-1035

485.00€

Rebitadora pneumática de fêmeas

Caraterísticas:
 Dimensões: 270x190mm
 Capacidade: M4-M10 (aço)
 Capacidade: M4-M8 (aço inox)
 Curso: 6mm
 Peso: 1 550g
 Consumo ar: 1,5l/ciclo
 Interior mangueira: 10mmø



JAT-1035-RK

7.80€

Kit de reparação para JAT-1035

JAT-460

31.00€

Bomba de massa manual de ponteira rígida

Acionamento por alavanca
 Capacidade: 400cc



JAT-481

46.00€

Bomba de massa manual de ponteira flexível

Acionamento por pistolete
 Capacidade: 400cc



JAT-480-NS

10.40€

Ponteira flexível para JAT-480



JAT-6004K

75.00€

Bomba de massa pneumática de ponteira rígida com acessórios

Acionamento por pneumático
 Capacidade: 400cc

Acessórios:



Ponteira flexível
 Alavanca por acionamento manual

JAT-501

65.00€

Pistola pneumática para mastique

Caraterísticas:
 Entrada: 1/4"
 Capacidade: 310ml
 Pressão: 2,5 a 5,1bar
 Interior mangueira: 10mmø
 Cartucho tipo "Salsichão"



JA-5032

37.00€

Pistola pneumática para mastique

Caraterísticas:
 Pressão: 2 a 4bar
 Comprimento: 330mm
 Peso: 1 225g
 Consumo ar: 170l/min
 Interior mangueira: 10mmø
 Material: metal



JAZ-3811E

67.00€

Balaceiro

Caraterísticas:
 Capacidade de carga: 3 a 5kg
 Comprimento do fio: 1,5mt
 Diâmetro do fio: 3,2mm



JA-3812A

44.00€

Balaceiro

Caraterísticas:
 Capacidade de carga: 0,5 a 1,2kg
 Comprimento do fio: 1,6m
 Diâmetro do fio: 1,8mm
 Peso: 560g



JA-3812D

46.00€

Balaceiro

Caraterísticas:
 Capacidade de carga: 1 a 2kg
 Comprimento do fio: 1,6m
 Diâmetro do fio: 1,8mm
 Peso: 560g



JAT-6904S

19.00€

Pistolete para água com kit de acessórios com 5 bicos

JAT-6905B

18.00€

Pistolete de ar

JAT-6905S

35.00€

Pistolete de ar com conjunto de acessórios

JAT-6905-C

3.40€

 Bico para pistolete de ar
Bico triangular espalmado

JAT-6905-J

12.60€

 Bico para pistolete de ar
Bico com escova em nylon

JAT-6959

6.80€

Pistola para ar de bico longo de 1/4"

 Comprimento: 100mm
Pressão trabalho: 75-120psi
Ruído: 85-90dba
Fêmea: 1/4"

JAT-6959A

8.30€

Pistola para ar de bico longo de 1/4"

 Comprimento: 280mm
Pressão trabalho: 75-120psi
Ruído: 85-90dba
Fêmea: 1/4"

Acessórios para redes de ar comprimido
JAZ-000

Enrolador ar

Ref.	Mangueira ø (mm)	Mangueira compri.(m)	Preço
JAZ-0001B	8x12	15	150.00€
JAZ-0002A	8x12	9	111.00€
JAZ-0002B	9,5x13,3	7,5	104.00€
JAZ-0002C	6,5x10	10	110.00€

JAZ-39520

198.00€

Enrolador móvel para ar de 3/8"

 Comprimento: 20m
Pressão máxima: 15bar
Peso: 7 000g
Interior mangueira: 9,5mmø
Ligação: 3/8"

JA-725

Mini lubrificador óleo para máquinas pneumáticas

Ref.	Medida	Preço
JA-7253	1/4"	7.90€
JA-7254	3/8"	11.50€

JAZ-0042

16.00€

Cardan para máquinas pneumáticas 1/4"

JAZ-0513

Copo plástico para filtros lubrificadores JAZ-0512/ JAZ-0513

Ref.	Especif.	Preço
JAZ-0514-06	purga	2.50€
JAZ-0513-09	copo ar	5.20€
JAZ-0514-13	freio	0.35€
JAZ-0513-50	óleo	5.20€

JAZ-0514

Copo plástico para filtros lubrificadores JAZ-0514/ JAZ-0515

Ref.	Especif.	Preço
JAZ-0514-06	purga	2.50€
JAZ-0514-09	copo ar	9.80€
JAZ-0514-13	freio	0.35€
JAZ-0514-48	copo óleo	7.00€



JAZ-051

Filtro lubrificador com regulador de pressão



Ref.	Entrada	Fluxo (l/min)	Pressão (bar)	Filtro (µm)	Preço
JAZ-0512	1/4"	1 000	0,5-8,5	5	76.50€
JAZ-0513	3/8"	1 350	0,5-8,5	5	83.00€
JAZ-0514	1/2"	3 000	0,5-8,5	5	112.00€
JAZ-0516	3/4"	3 100	0,5-8,5	5	122.00€

Nota: A pressão máxima de alimentação é de 8.5bar

JAZ-6704A

Filtro lubrificador com regulador de pressão



Entrada	Fluxo (l/min)	Pressão (bar)	Filtro (µm)	Preço
1/2"	1 250	1-10	5	110.00€

JAZ-6710A

Filtro de ar 1/2"



43.00€

JAZ-6711A

Regulador de pressão 1/2"



53.50€

JAZ-6712A

Lubrificador de ar 1/2"



44.00€

JAZ-6715A

Filtro de ar com regulador 1/2"



71.00€

JAZ-6704

Copo plástico para filtros lubrificadores JAZ-6704A/ JAZ-6710A

Ref.	Especif.	Preço
JAZ-6704-W	ar	10.40€
JAZ-6704-O	óleo	5.50€

JAZ-7214

Tubo espiral fêmea de 1/4"



Ref.	Medida (mm)	Compr. (m)	Preço
JAZ-7214F	5x8	13	26.00€
JAZ-7214S	6,5x10	13	31.00€
JAZ-7214Z	8x12	15	52.50€

GM-0

Tomada rápida fêmea



Ref.	Medida	Preço
GM-02AF	1/4"	6.50€
GM-03AF	3/8"	6.90€
GM-04AF	1/2"	7.20€

GM-0

Tomada rápida macho



Ref.	Medida	Preço
GM-02AM	1/4"	6.80€
GM-03AM	3/8"	6.50€
GM-04AM	1/2"	7.00€

GM-0

Tomada rápida tubo



Ref.	Medida	Preço
GM-02AH	1/4"	7.00€
GM-03AH	3/8"	7.40€
GM-04AH	1/2"	7.30€
GM-02BH	5/16"	7.50€

GM-0

Ponteira fêmea

Ref.	Medida	Preço
GM-02PF	1/4"	1.30€
GM-03PF	3/8"	2.30€
GM-04PF	1/2"	2.70€



GM-0

Ponteira macho

Ref.	Medida	Preço
GM-02PM	1/4"	1.20€
GM-03PM	3/8"	2.10€
GM-04PM	1/2"	2.50€



Acessórios para redes de ar comprimido

GM-0

Ponteira tubo

Ref.	Medida	Preço
GM-02PH	1/4"	1.40€
GM-03PH	3/8"	1.40€
GM-04PH	1/2"	1.70€
GM-02BPH	5/16"	1.40€



KIT AR

58.00€

Jogo de acessórios de ligação a rede de ar

Composição:

- GM-02AF Tomada rápida fêmea de 1/4"
- GM-02PF Ponteira fêmea de 1/4"
- GM-02PM Ponteira macho de 1/4"
- JAT-6905B Pistolete simples para ar
- JAZ-7214S Tubo espiral 13m





JONNESWAY®

Ferramentas Profissionais





JONNESWAY®

Merchandising



Merchandising

BOUTJW01A-M	12.35€
BOUTJW01A-L	12.35€
BOUTJW01A-XL	12.35€

T-shirt

Com o logotipo da Jonnesway estampado no peito e na manga, nos tamanhos M, L e XL.



BOUTJW02A	8.50€
------------------	-------

Boné

Com o logotipo da Jonnesway bordado.



JW-01B	18.00€
---------------	--------

Boné

Com o logotipo da Jonnesway bordado.



BOUTJW03B	38.50€
------------------	--------

Esferográfica 50 unidades

Com o logotipo da Jonnesway.



BOUTJW04A-M	35.50€
--------------------	--------

BOUTJW04A-L	35.50€
--------------------	--------

BOUTJW04A-XL	35.50€
---------------------	--------

Polar bege

Com o logotipo da Jonnesway bordado no peito, nos tamanhos M, L e XL.



BOUTJW05A	23.00€
------------------	--------

Guarda-chuva 1 unidade

Com o logotipo da Jonnesway estampado.



BOUTJW06B	30.00€
------------------	--------

Lona Jonnesway

Medidas: 1 480x890mm



BOUTJW07A-M	18.50€
--------------------	--------

BOUTJW07A-L	18.50€
--------------------	--------

BOUTJW07A-XL	18.50€
---------------------	--------

Polo

Com o logotipo da Jonnesway bordado no peito, nos tamanhos M, L e XL.



BOUTJW07B-M	25.50€
--------------------	--------

BOUTJW07B-L	25.50€
--------------------	--------

BOUTJW07B-XL	25.50€
---------------------	--------

Polo

Com o logotipo da Jonnesway bordado no peito, nos tamanhos M, L e XL.



BOUTJW08B-50	65.00€
BOUTJW08B-52	65.00€
BOUTJW08B-54	65.00€

Fato-macaco cinza
Com o logotipo da Jonnesway estampado no peito e nas costas.



JW-USB	17.00€
---------------	--------

Dispositivo de armazenamento de dados - pen USB 1 unidade
Capacidade: 16 Gb



BOUTJW13A	7.50€
------------------	-------

Para-sol
Com o logotipo da Jonnesway.



BOUTJW14B	24.50€
------------------	--------

Mochila
Com o logotipo da Jonnesway bordado.
Dimensões: 280x380x120mm



JW-BACKPACK	105.00€
--------------------	---------

Mochila



BOUTJW15B	81.00€
------------------	--------

Esferográfica "touch" 50 unidades
Com o logotipo da Jonnesway.

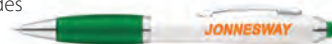

BOUTJW16A	3.40€
------------------	-------

Porta chaves 1 unidade



BOUTJW17A-1	4.30€
--------------------	-------

Autocolante Jonnesway
Medidas: 70x400mm



BOUTJW17A-2	10.80€
--------------------	--------

Autocolante Jonnesway
Medidas: 100x600mm



BOUTJW18A	5.20€
------------------	-------

Esferográfica
Com o logotipo da Jonnesway.



BOUTJW19A 40.00€

Esferográfica "roller ball"
Com o logotipo da Jonnesway.



BOUTJW20A-M 28.00€

BOUTJW20A-L 28.00€

BOUTJW20A-XL 28.00€

Sweat shirt

Com o logotipo da Jonnesway bordado no peito,
nos tamanhos M, L e XL.



BOUTJW21A-M 73.00€

BOUTJW21A-L 73.00€

BOUTJW21A-XL 73.00€

Colete

Com o logotipo da Jonnesway bordado no peito,
nos tamanhos M, L e XL.



BOUTJW22A-M 65.00€

BOUTJW22A-L 65.00€

BOUTJW22A-XL 65.00€

Casaco

Com o logotipo da Jonnesway bordado no peito,
nos tamanhos M, L e XL.



BOUTJW23A-M 51.00€

BOUTJW23A-L 51.00€

BOUTJW23A-XL 51.00€

Calças

Com o logotipo da Jonnesway bordado,
nos tamanhos M, L e XL.



BOUTJW24A 8.00€

Bloco de notas A5

Com o logotipo da Jonnesway.

Medidas: 140x210mm



BOUTJW25B 40.50€

Pasta A4

Com o logotipo da Jonnesway estampado.

Medidas: 245x325x40mm



BOUTJW26A 73.00€

Mala para portátil

Com o logotipo da Jonnesway estampado.

Medidas: 410x300x80mm



BOUTJW27A

27.50€

Rato sem fios
Com o logotipo da Jonnesway.



BOUTJW28A

23.00€

Base carregadora por indução para telemóveis
Dimensões: 69x10mm

Caraterísticas:
Carregador por indução com potência de carga até 10w.
Inclui cabo USB/ micro USB.
Compatível com smartphones com tecnologia de carregamento sem fios.



BOUTJW29A

182.00€

Bandeira barbatana tubarão
Dimensões: 660x2000mm



C-DSP

515.00€

Expositor para ferramenta com painéis perfurados e 30 ganchos

Medidas:
Altura: 2 140mm
Profundidade: 660mm
Largura: 940mm



Merchandising

C-DSP-0WB10

1.30€

Gancho para expositor C-DSP

DS96

120.00€

Expositor vazio para chaves de fenda

Capacidade: 96 chaves
Dimensões: 595x240x210mm



C-DS14

170.00€

Expositor para chaves caixa

Dimensões: 350x420x350mm



JAZ-ST4

42.00€

Base em acrílico para máquinas pneumáticas



FITA JW

4.00€

Fita Jonnesway para embalagem



JW-OPENER

4.50€

Tira cápsulas





JONNESWAY®

Ferramentas Profissionais





JONNESWAY®

Outros Equipamentos

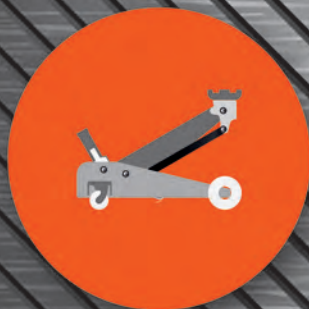

Outros equipamentos

AE020009

405.00€

Bomba hidropneumática

Pressão de serviço: 690bar
 Alimentação: 7-10bar
 Dimensões: 257,50x127x204,50mm
 Peso: 8 000g
 Capacidade: 1 660cc



AE060002

699.00€

Macaco para transmissões

Altura máxima: 750mm
 Altura mínima: 200mm
 Capacidade: 1t
 Dimensões: 865x480mm
 Peso: 60kg



AE060003

1 300.00€

Macaco para transmissões

Altura máxima: 890mm
 Altura mínima: 165mm
 Capacidade: 1,5t
 Dimensões: 1 105x652mm
 Peso: 130kg



AE070002A

540.00€

Macaco de fossa

Altura máxima: 1 835mm
 Altura mínima: 1 035mm
 Capacidade: 600kg

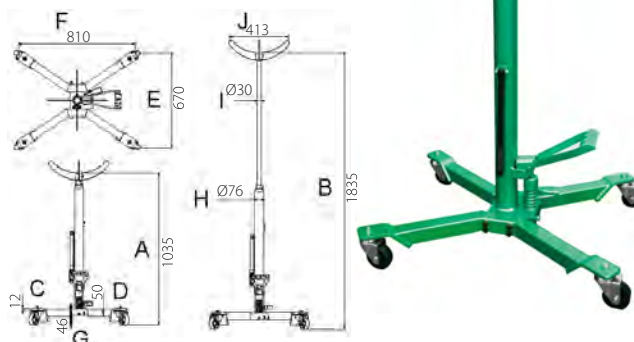

AE080001

690.00€

Macaco de fossa com prato universal

Altura máxima: 1 377mm
 Altura mínima: 880mm
 Capacidade: 500kg
 Prato: 729x597mm

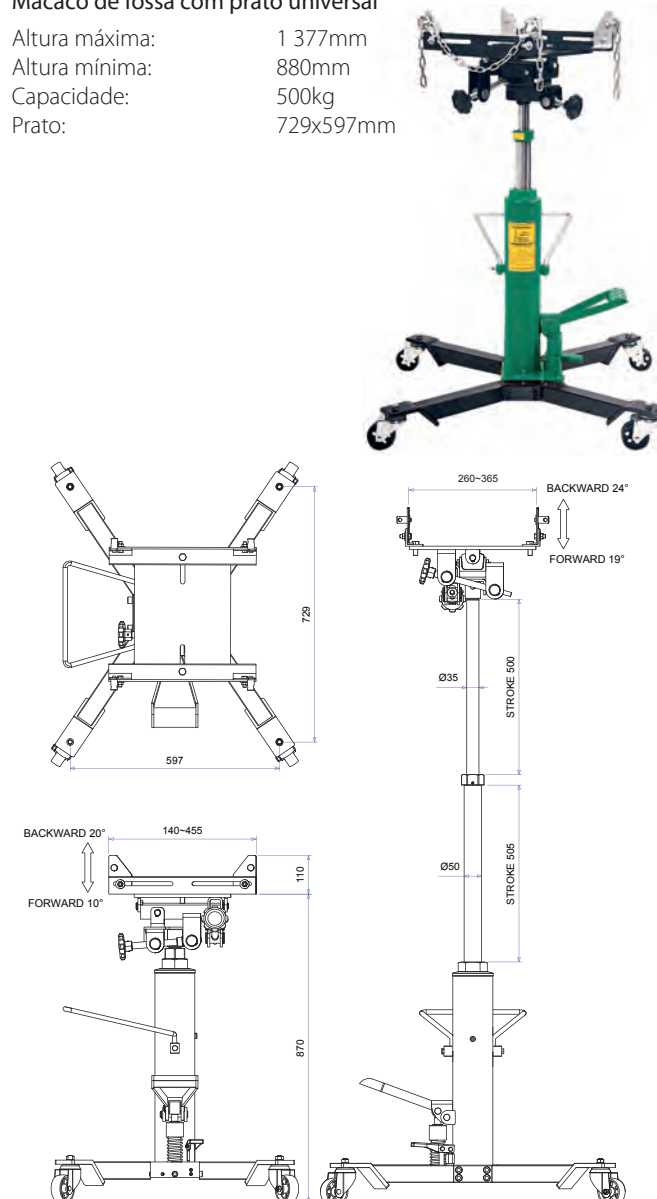

AG010236

65.00€

Suporte para movimentar pneus/ rodas



AG010154

15.00€

Banco plástico de apoio com rodas

Dimensões: 450x335x310mm
Peso: 1 500g



AG010219

119.00€

Banco metálico com rodas

Dimensões: 350x260x240mm
Capacidade: 150kg

Inclui: Gaveta
Suporte lateral para peças
Prateleira de apoio



AG010222

84.00€

Banco metálico com rodas

Dimensões: 330x350x560mm
Capacidade: 130kg

Inclui: Gaveta
Suportes laterais para peças



AE090105A

58.00€

Estrado para mecânico

Dimensões: 1 000x470x130mm
Carga admissível: 120kg



AE110020

999.00€

Macaco hidropneumático

Altura máxima: 377mm
Altura mínima: 205mm
Capacidade: 20t

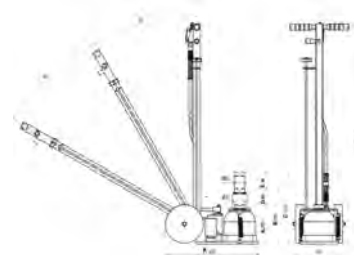

AE130003

960.00€

Grua hidráulica de 2t

Características em mm:
Altura mínima: 60
Elevação máxima: 2 330
Largura da base: 718-936
Comprimento da base: 1 606-2 426
Comprimento máximo braço: 1 960



AE130003-1

103.00€

Travessa

Capacidade: 500kg



AE140013

765.00€

Suporte articulado de motores

Capacidade: 600kg



AE150001

215.00€

Preguiça

Altura: 710-1 065mm
Capacidade: 12t



AE150002

190.00€

Preguiça para pesados

Altura: 456-710mm
Capacidade: 12t



AE170002

150.00€

Travessa para suporte de motores

Ajuste: 530-1 480mm



AE010025A

340.00€

Jogo prensa de chapeiro de 4t

Composição:
Bomba hidráulica manual
Cilindro hidráulico: 4t (369-522mm)
Pinça de alargamento
Adaptadores
Extensões
Mala com rodas



AE010015A

540.00€

Jogo prensa de chapeiro de 10t

Composição:
Bomba hidráulica manual
Cilindro hidráulico: 10t (369-522mm)
Pinça de alargamento
Adaptadores
Extensões
Mala com rodas



AE050003

170.00€

Macaco chapeiro 5t

Capacidade: 5t
Comprimento: 750mm
Curso pistão: 160mm



AE180001

245.00€

Travessa para portas

Comprimento: 74-115mm



AE200003

1 180.00€

Elevador para rodas veículos pesados

Capacidade: 600kg
Elevação: 395 mm



AE300149

157.00€

Aparadeira de óleo

Aparadeira regulável em polietileno de alta densidade com descarga por gravidade.

Capacidade: 50l
 Peso: 12kg
 Dimensões: 550x550x990~1 070 mm



AR020016

91.00€

Multímetro digital e analisador automóvel

Funções: RPM, dwell, volts AC/DC, amps DC, resistências, ciclo de trabalho, temperatura, testes díodos e teste continuidade.



AR020060

225.00€

Pinça amperimétrica

De acordo com a norma IEC 1010 CAT III 1 000V

Multímetro digital com escalas automáticas
 Multifunções para AC/DV amp; AC/DC V e Ohms
 Capacitância, frequência e díodos
 Proteção de sobrecarga
 Memória
 RMS (valor eficaz)
 Pinça amperimétrica: 2 000A - AC/DC
 Gama medição: 2 000 A AC/400A DC



AR020061

169.00€

Multímetro digital

De acordo com a norma IEC 1010 CAT III 1 000V

Mostrador de grande dimensão
 Escalas automáticas AC/DC para voltagem, amperagem, capacitância, frequência e resistência
 Leitura até 10 Amp com proteção e impedância alta para leituras de mV
 Memória
 RMS (valor eficaz)



AR030067

40.00€

Medidor de voltagem multifuncional

Pilhas não incluídas

Leitura de corrente AC/DC: 12-690V
 Mostrador LED/LCD



C-T4A

550.00€

Bancada de trabalho cinzenta com 3 gavetas

Tampo metálico com cobertura em acrílico

Medidas:
 Altura: 800mm
 Profundidade: 700mm
 Largura: 1 525mm



C-T5G-DP

118.00€

Painel traseiro cinzento para bancada

Aplicação:
 Bancada: C-T4A

Medidas:
 Altura: 700mm
 Largura: 1 525mm

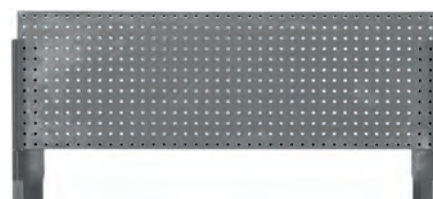

C-DBU1

1.60€

Gancho para painel traseiro de bancada

Aplicação:
 Painel: C-T5G-DP
 Armários: C-SA
 Comprimento: 25,4mm



C-DBU7

1.80€

Gancho para painel perfurado

Aplicação:
 Painel: C-T5G-DP
 Armários: C-SA
 Comprimento: 50,8mm



AB	Pág.						
AB010001	156	AB030076-28	162	AE300202	126	AE330015	159
AB010002	156	AB030076-30	162	AE300204	126	AE330016	159
AB010002-A	156	AB030076-32	162	AE300205	126	AE330030	159
AB010017	156	AB030076-34	162	AE300206	126	AE330034	159
AB010018	156	AB030089	158	AE300207	126	AE330035	160
AB010019	156	AB030094J	158	AE300211	126	AGO	Pág.
AB010020	156	AB030100	158	AE300212	123	AG010002	88
AB010026S	156	AC	Pág.	AE300215	127	AG010002S	88
AB010041	157	ACC-609	177	AE300220	127	AG010002SP	28
AB010043	157	AE0	Pág.	AE300221-02	140	AG010003	88
AB020002	157	AE010015A	193	AE300221-03	140	AG010005	88
AB020003	157	AE010025A	193	AE300221-04	140	AG010006	88
AB020009	157	AE020009	192	AE310002	123	AG010008	89
AB020010	157	AE040020	122	AE310003	159	AG010009	89
AB020015	157	AE050003	193	AE310006	123	AG010011	89
AB020019	157	AE060002	192	AE310008	123	AG010012	89
AB030001	157	AE060003	192	AE310010A	123	AG010023	159
AB030014	157	AE070002A	192	AE310013	123	AG010024	159
AB030028	157	AE080001	192	AE310014	123	AG010024-1	159
AB030041	157	AE090105A	192	AE310016	123	AG010024-2	159
AB030043	157	AE1	Pág.	AE310024	123	AG010026SP	28
AB030046	157	AE110020	192	AE310025	123	AG010030A	159
AB030047	157	AE130003	192	AE310026	123	AG010034	127
AB030048	157	AE130003-1	192	AE310027	123	AG010035	127
AB030056	122	AE140013	192	AE310034	124	AG010036	127
AB030060	158	AE150001	193	AE310035	124	AG010046	127
AB030061	122	AE150002	193	AE310037	124	AG010049	127
AB030068A	158	AE150005	122	AE310038	124	AG010055	159
AB030068C	158	AE170002	193	AE310062	124	AG010055-B	159
AB030068D	158	AE180001	193	AE310063	124	AG010059	127
AB030068F	158	AE2	Pág.	AE310066	124	AG010059-10	127
AB030069A	158	AE200003	193	AE310073	124	AG010059-12	127
AB030069B	158	AE3	Pág.	AE310077	124	AG010059-6	127
AB030069E	158	AE300064	122	AE310087	124	AG010059-8	127
AB030070B	158	AE300064-02	122	AE310099	124	AG010089	127
AB030070C	158	AE300064-03	122	AE310109A	125	AG010099	128
AB030070D	158	AE300064-04	122	AE310110	125	AG010109	128
AB030071	158	AE300064-05	122	AE310112	125	AG010111	127
AB030076-00	162	AE300064-06	122	AE310122	124	AG010118A	128
AB030076-01	162	AE300064-07	122	AE310146B	125	AG010138	160
AB030076-02	162	AE300064-15	122	AE310146D	125	AG010138-B	160
AB030076-03	162	AE300064-16	122	AE310146E	125	AG010140	160
AB030076-05	162	AE300100-040	122	AE310146G	125	AG010141	160
AB030076-06	162	AE300100-042	122	AE310146H	125	AG010142	160
AB030076-07	162	AE300100-060	122	AE310150	124	AG010143	160
AB030076-11	162	AE300103	122	AE310172	125	AG010147	128
AB030076-13	162	AE300149	194	AE310180	125	AG010150SC	28
AB030076-14	162	AE300152	122	AE310183	125	AG010154	192
AB030076-15	162	AE300154B	126	AE320023	125	AG010159	127
AB030076-17	162	AE300168	126	AE320034	125	AG010163A	127
AB030076-18	162	AE300168-1	126	AE320035	125	AG010164	127
AB030076-20	162	AE300173	123	AE320044	125	AG010167	162
AB030076-21	162	AE300176-A	123	AE330004	159	AG010168	162
AB030076-24	162	AE300179-02	140	AE330005	159	AG010169	162
AB030076-26	162	AE300179-03	140	AE330008	159	AG010184B	77
AB030076-27	162	AE300180	140	AE330009	159	AG010184C	77
		AE300201	126	AE330013	159	AG010184D	77

AG010184E	77	AI010139	147	AI030010	135	AI060030	140
AG010184F	77	AI010153	161	AI030011	135	AI060030-A	140
AG010185	159	AI010166	131	AI030020	135	AI060030-B	140
AG010204	149	AI010167	131	AI030025	135	AI060030-C	140
AG010205	144	AI010176	132	AI030027	135	AI060030-D	141
AG010207	114	AI010195	132	AI030045	112	AI060030-E	141
AG010208	128	AI010201	136	AI030067	138	AI060030-F	141
AG010219	192	AI020015	132	AI030075	143	AI060031	141
AG010222	192	AI020019	132	AI040005	135	AI060031-A	141
AG010224	114	AI020020	132	AI040006	136	AI060031-B	141
AG010225	128	AI020021	132	AI040007	135	AI060031-C	141
AG010227	128	AI020024	132	AI040008	135	AI060031-D	141
AG010229	128	AI020025	132	AI040011	136	AI060031-E	141
AG010236	192	AI020027	132	AI040017	136	AI060031-G	141
AG1	Pág.	AI020043	132	AI040018	136	AI060031-H	141
AG10001SP	28	AI020047	132	AI040031	135	AI060031-J	141
AG10001SP-D	129	AI020048A	132	AI040060	136	AI1	Pág.
AG10001SP-G	128	AI020048D	132	AI040245	161	AI10001SP	28
AG10001SP-T	129	AI020048E	132	AI040246	136	AI10002SP	28
AG10001SP-W	129	AI020049	132	AI050001	138	AI10003SP	29
AG10002SC	39	AI020051	132	AI050004	136	ALO	Pág.
AG10002SC-W	129	AI020052	133	AI050004A	137	AL010006	141
AH0	Pág.	AI020054	133	AI050009A	137	AL010011	141
AH020002	129	AI020056A	133	AI050022	138	AL010029	152
AIO	Pág.	AI020066	133	AI050024	138	AL010038	151
AI010006	129	AI020074	126	AI050037	138	AL010041	151
AI010009	129	AI020092	133	AI050040	138	AL010044	148
AI010017	129	AI020101A	133	AI050042	138	AL010053A	152
AI010023	129	AI020101A-A	133	AI050043	138	AL010057	150
AI010029	129	AI020103	133	AI050043S	135	AL010070	148
AI010030	129	AI020107	133	AI050071S	150	AL010071	148
AI010033	139	AI020109	134	AI050071S	148	AL010072	152
AI010037	130	AI020113	150	AI050076	138	AL010073	141
AI010041	130	AI020127	152	AI050077	138	AL010087	153
AI010060	131	AI020131	134	AI050079	152	AL010088	153
AI010060-A	131	AI020142	134	AI050080	138	AL010093	140
AI010060-B	131	AI020154	152	AI050085A	150	AL010099	147
AI010060-C	131	AI020158	162	AI050092	139	AL010113	161
AI010060-D	131	AI020162	134	AI050093	139	AL010114	161
AI010063A	131	AI020163	134	AI050096S	139	AL010116	161
AI010069	152	AI020164	161	AI050102	139	AL010117	161
AI010070	152	AI020178	134	AI050104	139	AL010128	147
AI010086	131	AI020180	134	AI050109	139	AL010175	150
AI010090A	131	AI020184	150	AI050113	139	AL010175	148
AI010092	131	AI020184	134	AI050135	161	AL010190	151
AI010097	149	AI020184A	152	AI050152	139	AL010196	148
AI010104	131	AI020184A	134	AI050152A	139	AL010202	153
AI010107	148	AI020184A	148	AI050172	161	AL010203	153
AI010108	153	AI020184B	150	AI050175	138	AL010205	149
AI010110	153	AI020184B	134	AI050176	139	AL010218	149
AI010114	149	AI020184S	134	AI050191	140	AL010225	153
AI010115	147	AI020185	134	AI050192	140	AL010282	149
AI010116	149	AI020186	150	AI050200	150	AL010291	153
AI010121	147	AI020201	135	AI050201	152	ANO	Pág.
AI010127	131	AI020205	135	AI050202	139	AN010001	141
AI010136	150	AI030002	136	AI060006	140	AN010001C	141
AI010137	131	AI030007	135	AI060020	140	AN010001D	142

AN010001D-2	142	AN020007-1	144	AS-0013A2	177	BOUTJW28A	191
AN010001D-3	142	AN020022	145	AS-0013C	177	BOUTJW29A	191
AN010001D-4	142	AN020022-A	145	AS-0015	177	C-1	Pág.
AN010001D-5	142	AN020022-B	145	AS-0015C	177	C-10DW42	22
AN010001D-6	142	AN020022-C	145	AS-0026	177	C-13DW53	22
AN010001D-7	142	AN020022-D	145	AS-0065	127	C-1DM1	20
AN010001D-A	142	AN040035A	145	AT	Pág.	C-3	Pág.
AN010001D-E	142	AN040043A	145	AT-6034-1A	181	C-3DH2	23
AN010001D-F	142	AN040055	162	AT-6952P-37	180	C-3DH262	23
AN010001D-K	142	AN040056	162	AZ	Pág.	C-3DH5	23
AN010001D-M	142	AN040062	161	AZ-0514-06	183	C-3DW5	20
AN010001D-N	142	AN040066	161	BL	Pág.	C-4	Pág.
AN010009A	138	AN040082	145	BLACK POWER 19	9	C-4DWA1	21
AN010030	138	AN040100	151	BO	Pág.	C-4DWA1G	21
AN010033	142	AN040101	145	BOUTJW01A-L	188	C-5	Pág.
AN010038	142	AN040105	161	BOUTJW01A-M	188	C-5CD	23
AN010045	124	AN040126	150	BOUTJW01A-XL	188	C-6	Pág.
AN010049	142	AN040168	145	BOUTJW02A	188	C-6DA4	23
AN010054A	143	AN040200	161	BOUTJW03B	188	C-6DA494	23
AN010054N	143	AN040286	149	BOUTJW04A-L	188	C-6DWB1	21
AN010063	142	AN040327	143	BOUTJW04A-M	188	C-6DWB5	21
AN010065	142	AN1	Pág.	BOUTJW04A-XL	188	C-7	Pág.
AN010066	143	AN100002SP	29	BOUTJW05A	188	C-7 TOWER	22
AN010068	143	ARO	Pág.	BOUTJW06B	188	C-7DC2B	21
AN010072	143	AR020016	194	BOUTJW07A-L	188	C-7DS1	21
AN010072C	143	AR020018	145	BOUTJW07A-M	188	C-7DW1-TS	24
AN010081A	142	AR020019	145	BOUTJW07A-XL	188	C-7DW9	21
AN010085A	142	AR020053A	145	BOUTJW07B-L	188	C-A	Pág.
AN010091A	143	AR020060	194	BOUTJW07B-M	188	C-A10	25
AN010092	143	AR020061	194	BOUTJW07B-XL	188	C-A11	25
AN010102	142	AR030013	145	BOUTJW08B-50	189	C-A12	25
AN010106A	143	AR030022	162	BOUTJW08B-52	189	C-A13	25
AN010106A-C	143	AR030034	145	BOUTJW08B-54	189	C-A16W	22
AN010112	143	AR030041	146	BOUTJW13A	189	C-A17W	22
AN010131	143	AR030047	146	BOUTJW14B	189	C-A17WG	22
AN010137	144	AR030058	93	BOUTJW15B	189	C-A2501S	25
AN010160	142	AR030062	146	BOUTJW16A	189	C-A27	24
AN010177B	147	AR030067	194	BOUTJW17A-1	189	C-A3	24
AN010186B	144	AR040016	146	BOUTJW17A-2	189	C-A3-B	24
AN010187	161	AR040043	146	BOUTJW18A	189	C-A31	24
AN010188A	144	AR060002A	146	BOUTJW19A	190	C-A3G	24
AN010188B	144	AR060003	146	BOUTJW20A-L	190	C-A456	24
AN010188C	144	AR060008	146	BOUTJW20A-M	190	C-A7	25
AN010202	153	AR060010	146	BOUTJW20A-XL	190	C-A8	25
AN010202B	153	AR060011	146	BOUTJW21A-L	190	C-A9	24
AN010225	144	AR060020	146	BOUTJW21A-M	190	C-APB	25
AN010226	144	AR060021	146	BOUTJW21A-XL	190	C-B	Pág.
AN010235	161	AR060024A	147	BOUTJW22A-L	190	C-B5	25
AN010237	161	AR060032	147	BOUTJW22A-M	190	C-BS Kit1	24
AN010272	144	AR060038	146	BOUTJW22A-XL	190	C-BS Kit2	24
AN010279	144	AR060039A	146	BOUTJW23A-L	190	C-BS Kit3	24
AN010293	142	AR060043	147	BOUTJW23A-M	190	C-D	Pág.
AN010319	144	AR060055	146	BOUTJW23A-XL	190	C-DBU1	194
AN010320	144	AR060056	146	BOUTJW24A	190	C-DBU7	194
AN010321	142	AR060062	143	BOUTJW25B	190	C-DM1	114
AN010322	142	AS	Pág.	BOUTJW26A	190	C-DMH212	75
AN020007	144	AS-0013	177	BOUTJW27A	191	C-DMH314	75

C-DMH414	75	D10	Pág.	D130H120	103	D175T50	104
C-DS14	191	D100MN08M	104	D130H40	103	D175T55	104
C-DSP	191	D100MN10M	104	D130H50	103	D37	Pág.
C-DSP-0WB10	191	D100MN12M	104	D130H60	103	D3750P0	100
C-P	Pág.	D100MN13M	104	D130H70	103	D3750P00	100
C-PC1	24	D100MN14M	104	D130H80	103	D3750P08S	100
C-PC2	24	D10M30M05A	104	D130T20	103	D3750P1	100
C-PC3	24	D10M30M06A	104	D130T25	103	D3750S10	100
C-PC4	24	D10M30M08A	104	D130T30	103	D3750S16	100
C-S	Pág.	D10M30M10A	104	D130T40	103	D3750S20	100
C-S7DW1	19	D10M30M12A	104	D130T45	103	D3750S24	100
C-SA2	18	D10M30M14A	104	D130T50	103	D3750S30	100
C-SA2S	18	D10M75M05A	104	D130T55	103	D3750T08S	100
C-SA3	18	D10M75M06A	104	D15	Pág.	D3750T10	100
C-SA3S	18	D10M75M08A	104	D150F5510A	103	D3750T15	100
C-SA4S	19	D10M75M10A	104	D150F6512A	103	D3750T18S	100
C-SG	20	D10M75M12A	104	D150F8012A	103	D3750T20	100
C-SInox	20	D10M75M14A	104	D150H030A	104	D3750T5	100
C-SM	20	D12	Pág.	D150H040B	104	D3750T6	100
C-SP3401	19	D125F4506A	103	D150H050A	104	D3750T7	100
C-SQ2401	19	D125F6512A	103	D150H060B	104	D3750T8	100
C-SQ3401	19	D125F8016A	103	D150H070B	104	D3750T9	100
C-SQ3402	19	D125H015A	103	D150H080B	104	D376514SC	39
C-SQ3403	19	D125H020A	103	D150MH1AD	104	D70	Pág.
C-SR3401	20	D125H025A	103	D150MH1QD	104	D70105KV	36
C-SU01	20	D125H030A	103	D150P1A	103	D70105SP	29
C-SU02	20	D125H040A	103	D150P2A	103	D70P175	96
C-SW01	20	D125H050A	103	D150P3A	103	D70P2100	96
C-SW02	20	D125H060A	103	D150T20A	104	D70P3125	96
C-T	Pág.	D125H070A	103	D150T25A	104	D70P3150	96
C-T12	23	D125P1F	103	D150T27A	104	D70PP07S	96
C-T3	22	D125P2F	103	D150T30A	104	D70PP10S	96
C-T4A	194	D125P3F	103	D150T40A	104	D70PS119KV	36
C-T5G-DP	194	D125T06B	103	D150Z1A	103	D70S475	96
C-W	Pág.	D125T08B	103	D150Z2A	103	D70S5100	96
C-WHEEL1	25	D125T10A	103	D150Z3A	103	D70S6125	96
C-WHEEL2	25	D125T15A	103	D16	Pág.	D70S6150	96
C-WHEEL5	25	D125T20A	103	D165MN06M	105	D70S8150	96
C-WHEEL6	25	D125T25A	103	D165MN07M	105	D70S8175	96
C-WHEEL8	25	D125T27A	103	D165MN08M	105	D70S9175	96
C-WHEEL9	25	D125T30A	103	D165MN10M	105	D70S9250	96
CF	Pág.	D125T40A	103	D165MN12M	105	D71	Pág.
CF-K-C	179	D125TT08B	104	D165MN13M	105	D71157SV	34
CF-K-E	179	D125TT10B	104	D17	Pág.	D71400T10	98
CF-K-E	180	D125TT15B	104	D175H100	104	D71400T15	98
CF-K-F	179	D125TT20B	104	D175H120	104	D71400T20	98
CF-K-G	179	D125TT25B	104	D175H40	104	D71400T25	98
CF-K-I	179	D125TT27B	104	D175H50	104	D71400T27	98
CF-K-J	179	D125TT30B	104	D175H60	104	D71400T30	98
CH	Pág.	D125TT35B	104	D175H70	104	D715N05	99
CHAPEIRO20- BLACK	14	D125TT40B	104	D175H80	104	D715N07	99
CHAPEIRO20-C	14	D125Z1A	103	D175T20	104	D715N08	99
CHAPEIRO20-V	14	D125Z2A	103	D175T25	104	D715N10	99
CHAPEIROALU-BLACK	15	D125Z3A	103	D175T30	104	D715N12	99
CHAPEIROALU-C	15	D13	Pág.	D175T40	104	D715N13	99
CHAPEIROALU-V	15	D130H100	103	D175T45	104	D71C105S	99

D71C106S	99	D71Z060	98	ELECTR-C	13	H01SA115	105
D71P060	97	D71Z105S	99	ELECTR-V	13	H01SA120	105
D71P1100	97	D71Z107S	100	ELECTR. 1000 BLACK	11	H01SA125	105
D71P1150	97	D71Z138	98	ELECTR. 1000-C	11	H01SA130	105
D71P1300	97	D71Z180	98	ELECTR. 1000-V	11	H01SA140	105
D71P138	97	D71Z2100	98	EV	Pág.	H01SA150	105
D71P180	97	D71Z3150	98	EVA POWER BLACK	7	H01SA160	105
D71P2100	97	D71Z4200	98	EVA POWER-C	7	H01SA180	105
D71P2150	97	D72	Pág.	EVA POWER-V	7	H01SM109S	105
D71P2250	97	D725N06	98	F	Pág.	H02	Pág.
D71P238	97	D725N07	98	FITA JW	191	H02MH217S	105
D71P2400	97	D725N08	98	GM	Pág.	H02SM109S	106
D71P3150	97	D725N08SP	29	GM-02AF	184	H02SM209S	106
D71P3250	97	D725N09	98	GM-02AH	184	H03	Pág.
D71P3400	97	D725N10	98	GM-02AM	184	H03MH118S	106
D71P4200	97	D725N11	98	GM-02BH	184	H03SM109S	106
D71PP08KV	36	D725N12	98	GM-02BPH	185	H03SS109S	106
D71PP08S	99	D725N13	98	GM-02PF	185	H05	Pág.
D71PP08SP	29	D73	Pág.	GM-02PH	185	H05SA109S	106
D71PP16S	99	D737128SV	34	GM-02PM	185	H05SS109S	106
D71S10250	97	D737134SV	34	GM-03AF	184	H06	Pág.
D71S250	97	DBT	Pág.	GM-03AH	184	H06MT109S	106
D71S360	97	DBT31B	101	GM-03AM	184	H06SA109S	106
D71S4100	97	DBT53A	101	GM-03PF	185	H06SA1100	106
D71S4150	97	DR0	Pág.	GM-03PH	185	H06SA115	106
D71S4200	97	DR0107S	101	GM-03PM	185	H06SA120	106
D71S480	97	DR0253S	101	GM-04AF	184	H06SA125	106
D71S5125	97	DR04	101	GM-04AH	184	H06SA130	106
D71S5200	97	DS9	Pág.	GM-04AM	184	H06SA140	106
D71S5300	97	DS96	191	GM-04PF	185	H06SA150	106
D71S538	97	DV1	Pág.	GM-04PH	185	H06SA160	106
D71S575	97	DV13P060	115	GM-04PM	185	H06SA180	106
D71S6100	97	DV13P180	115	H01	Pág.	H06SM209S	106
D71S6150	97	DV13P2100	115	H01B1015	105	H06SM2100	106
D71S638	97	DV13P3150	115	H01B1020	105	H06SM225	106
D71S6400	97	DV13PP07S	115	H01B1025	105	H06SM230	106
D71S8150	97	DV13S275	115	H01B1030	105	H06SM240	106
D71S8200	97	DV13S4100	115	H01B1035	105	H06SM250	106
D71S8300	97	DV13S5125	115	H01B1040	105	H06SM255	106
D71S8500	97	DV13S6150	115	H01B1045	105	H06SM260	106
D71S9175	97	DV13Z060	115	H01B1050	105	H06SM280	106
D71T10	98	DV13Z180	115	H01B1055	105	H06SN170	106
D71T107S	99	DV13Z2100	115	H01B1060	105	H06W106S	107
D71T109S	99	DV13Z3150	115	H01B1070	105	H07	Pág.
D71T15	98	DV14PP-TP	96	H01B1080	105	H07M09S	107
D71T20	98	DV15109S	116	H01B1090	105	H07MT10	107
D71T25	98	DV4	Pág.	H01B1100	105	H07MT15	107
D71T27	98	DV4118SV	115	H01B1120	105	H07MT20	107
D71T30	98	DV41M06S	116	H01B1140	105	H07MT25	107
D71T40	98	DV41M10	115	H01B1160	105	H07MT27	107
D71T45	98	DV41M13	115	H01B1170	105	H07MT30	107
D71T5	98	DV41M5	115	H01B1180	105	H07MT40	107
D71T50	98	DV41M6	115	H01B1190	105	H07MT45	107
D71T6	98	DV41M7	115	H01B1220	105	H07MT50	107
D71T7	98	DV41M8	115	H01MH118S	105	H08	Pág.
D71T8	98	EL	Pág.	H01SA109S	105	H0816S	107
D71T9	98	ELECTR-BLACK	13	H01SA1100	105	H08MTP09S	107

H08S110S	107	H20MT25	108	JA-7253	183	JAG-6639-DC	173
H08ST09085	107	H20MT27	108	JA-7254	183	JAG-6639-DR	173
H08ST10090	107	H20MT30	108	JA-950	177	JAG-6639-RK	173
H08ST15100	107	H20MT40	108	JA-950-04	177	JAH	Pág.
H08ST20115	107	H20MT45	108	JA-960	177	JAH-0288	181
H08ST25130	107	H20MT50	108	JA-C131SV	34	JAH-0288-15	181
H08ST27145	107	H22	Pág.	JA-HVLP-1080GD-N1.4	176	JAH-0288-16	181
H08ST30165	107	H22S109S	109	JA-HVLP-1080GK	176	JAH-0288-17	181
H08ST40185	107	HC	Pág.	JA-HVLP-3000-NS17	176	JAH-0288-RK	181
H08ST45205	107	HC-100/15	137	JA-HVLP-3000-NS19	176	JAH-308HK	181
H08ST50230	107	HC-106/15	137	JA-HVLP-300C (1.3)	176	JAH-308HK-RK	181
H10	Pág.	HC-108/15	137	JA-HVLP-6112	176	JAH-6837	181
H10121SV	34	HC-108/18	137	JA-LVLP-0303W	176	JAH-6837-50	181
H10MB08KV	37	HC-65/14	137	JA-LVLP-0303W-N	176	JAH-6837-50-2	181
H10MB08S	107	HC-65/67	137	JA-LVLP-0303W-N18	176	JAH-6837-RK	181
H10MB08SP	29	HC-65103	137	JAB	Pág.	JAH-7104H	181
H10MB10200	107	HC-66/6	137	JAB-1017	170	JAH-7104H-RK	181
H10MB2100	107	HC-68/14	137	JAB-1017-RK	170	JAI	Pág.
H10MB25100	107	HC-73/14	137	JAB-1018	170	JAI-0501-RK	168
H10MB3100	107	HC-74/15	137	JAB-1018-RK	170	JAI-0926-RK	166
H10MB4100	107	HC-74/76	137	JAB-7003A	171	JAI-0936	166
H10MB5150	107	HC-75/77	137	JAB-7003A-RK	171	JAI-0936-RK	166
H10MB6150	107	HC-76/12	137	JAD	Pág.	JAI-0938	167
H10MB8200	107	HC-76/14	137	JAD-0212	169	JAI-0938-RK	167
H10MT08KV	37	HC-76/30	137	JAD-0212-RK	169	JAI-0954	165
H10MT08SP	29	HC-76/8	137	JAD-0413	169	JAI-0954-RK	165
H10MT09S	107	HC-78/15	137	JAD-0413-RK	169	JAI-1024	164
H10MT10100	108	HC-80/15	137	JAD-0534	169	JAI-1024-RK	164
H10MT15100	108	HC-80/82	137	JAD-1015-RK	171	JAI-1054	165
H10MT20100	108	HC-86/16	137	JAD-1015K	171	JAI-1054-RK	165
H10MT25100	108	HC-86/18	137	JAD-1020	170	JAI-1114	164
H10MT27150	108	HC-9.5mm	137	JAD-1020-RK	170	JAI-1114-RK	164
H10MT30150	108	HC-90/15	137	JAD-1021	170	JAI-1114K	164
H10MT40150	108	HC-92/10	137	JAD-1021-RK	170	JAI-1124	164
H10MT45200	108	HC-93/15	137	JAD-1027	170	JAI-1124-RK	164
H10MT50200	108	HC-93/36	137	JAD-1027-RK	170	JAI-1138	167
H12	Pág.	HC-93/45	137	JAD-6252A	170	JAI-1138-RK	167
H12S09085	108	HC-95/15	137	JAD-6252A-RK	170	JAI-1138L	167
H12S10090	108	HC-96/18	137	JAG	Pág.	JAI-1206L	166
H12S110S	108	HV	Pág.	JAG-0903-MS	171	JAI-1206L-RK	167
H12S15100	108	HV1000V-BLACK	12	JAG-0906R/RM-RK	171	JAI-1232-RK	165
H12S20115	108	HV1000V-C	12	JAG-0906RMK	171	JAI-1232K	165
H12S25130	108	HV1000V-V	12	JAG-0913RM-RK	171	JAI-1408	167
H12S27145	108	JA	Pág.	JAG-0913RMK	171	JAI-1408-RK	167
H12S30165	108	JA-0001RK	177	JAG-0923RM	172	JAI-1408L	167
H12S40185	108	JA-300C-28	177	JAG-0923RM-RK	172	JAI-1513	165
H12S45205	108	JA-300C-NS13	176	JAG-0925RM	172	JAI-1513-RK	165
H12S50230	108	JA-3806C	177	JAG-0925RM-RK	172	JAI-1514	166
H15	Pág.	JA-3808A	177	JAG-0955RM	172	JAI-1514-RK	166
H15M105S	108	JA-3812A	182	JAG-0955RM-RK	172	JAI-1524	164
H20	Pág.	JA-3812D	182	JAG-1087	172	JAI-1524-RK	165
H20MB1037S	109	JA-5032	182	JAG-1087-RK	172	JAI-6202-RK	168
H20MT08SP	29	JA-6111-NS13	176	JAG-6638	172	JAI-6211	166
H20MT09S	109	JA-6111-NS17	176	JAG-6638-DC	172	JAI-6211-RK	166
H20MT10	108	JA-6111-NS20	176	JAG-6638-DR	172	JAI-6212-RK1	166
H20MT15	108	JA-6111(1.4)	176	JAG-6638-RK	172	JAI-6212K	166
H20MT20	108	JA-6111K	176	JAG-6639	172		

JAR	Pág.	JAS-6552-RK	173	JAT-69055	183	M04	Pág.
JAR-1012	168	JAT	Pág.	JAT-6943A	180	M04008	110
JAR-1012-RK	168	JAT-1011	178	JAT-6943A-RK	180	M04012	110
JAR-1013	168	JAT-1011-RK	178	JAT-6952	180	M04016	110
JAR-1013-RK	168	JAT-1020-RK	178	JAT-6952-RK	180	M04024	110
JAR-1033	169	JAT-1020K	178	JAT-6952P	180	M04032	110
JAR-1033-RK	169	JAT-1035	182	JAT-6952P-39	180	M05	Pág.
JAR-1094	168	JAT-1035-RK	182	JAT-6952P-40	180	M05020	110
JAR-1094-RK	168	JAT-1041	178	JAT-6952P-RK	180	M06	Pág.
JAR-6309A-RK	168	JAT-1041-16S	178	JAT-6959	183	M06030	110
JAR-6309AK	168	JAT-10T18	179	JAT-6959A	183	M06040	110
JAR-6310A	168	JAT-10T32	179	JAZ	Pág.	M07	Pág.
JAR-6310A-RK	169	JAT-12F1	178	JAZ-0001B	183	M07016	110
JAR-6310AK	169	JAT-12F2	178	JAZ-0002A	183	M07016-ACE	110
JAS	Pág.	JAT-12F3	178	JAZ-0002B	183	M07016-TPR	110
JAS-0010	173	JAT-12F4	178	JAZ-0002C	183	M09	Pág.
JAS-0010-41	173	JAT-20T14	178	JAZ-0042	183	M09100	110
JAS-0010-RK	173	JAT-20T18	178	JAZ-011H	181	M091000	110
JAS-0413	173	JAT-20T24	178	JAZ-016H	181	M09103KV	37
JAS-0413-RK	173	JAT-460	182	JAZ-0512	184	M09200	110
JAS-0423-31	174	JAT-480-NS	182	JAZ-0513	184	M09300	110
JAS-0423-RK	174	JAT-481	182	JAZ-0513-09	183	M09500	110
JAS-0423K	174	JAT-501	182	JAZ-0513-50	183	M09513SP	30
JAS-0452	177	JAT-6004K	182	JAZ-0514	184	M09800	110
JAS-0452-RK	178	JAT-6034	181	JAZ-0514-06	183	M10	Pág.
JAS-1021-6HE-RK	174	JAT-6034-1B	181	JAZ-0514-09	183	M10110	158
JAS-1021-6HE(2.5)	174	JAT-6034-1C	181	JAZ-0514-13	183	M10210A	158
JAS-1031-6HE	175	JAT-6034-1D	181	JAZ-0514-13	183	M10210B	158
JAS-1031-6HE-RK	175	JAT-6034-RK	181	JAZ-0514-48	183	M10410A	158
JAS-1031-6HP	175	JAT-6412	180	JAZ-0516	184	M10410B	158
JAS-1031-6HP	175	JAT-6412-RK	180	JAZ-3811E	182	M11	Pág.
JAS-1206-6HE	174	JAT-6421	179	JAZ-39520	183	M11035	110
JAS-1206-6HE-RK	174	JAT-6421-33	179	JAZ-6704-O	184	M11045	110
JAS-1206-6HP	174	JAT-6421-RK	179	JAZ-6704-W	184	M11065	110
JAS-1206-6HP	175	JAT-6441-RK	179	JAZ-6704A	184	M29	Pág.
JAS-1207-6HE	174	JAT-6441K	179	JAZ-6704A	184	M2927	110
JAS-1207-6HE-56	174	JAT-6443-K1	180	JAZ-6710A	184	M2927-T1	110
JAS-1207-6HE-57	175	JAT-6443-K2	180	JAZ-6711A	184	M2927-T2	110
JAS-1207-6HE-RK	174	JAT-6443-K3	180	JAZ-6712A	184	M2932	110
JAS-6505	173	JAT-6443-K4	180	JAZ-6715A	184	M2932-T1	110
JAS-6505-RK	173	JAT-6443-K5	180	JAZ-7207	171	M2932-T2	110
JAS-6531	175	JAT-6443-K6	180	JAZ-7214F	184	M2940-T1	110
JAS-6531-LIXA	175	JAT-6443-K7	180	JAZ-7214S	184	M2940-T2	110
JAS-6531-RK	175	JAT-6443-RK	180	JAZ-7214Z	184	M2950-T1	110
JAS-6535-5HE	175	JAT-6443K	180	JAZ-ST4	191	M2950-T2	110
JAS-6535-5HE-47	175	JAT-6613	179	JW	Pág.	M60	Pág.
JAS-6535-5HE-RK	175	JAT-6613-P	179	JW-01B	188	M60103	111
JAS-6535-5VE-RK	175	JAT-6613-PA	179	JW-BACKPACK	189	M60104	111
JAS-6535-6HE	175	JAT-6613-RK	179	JW-OPENER	191	M60105	111
JAS-6535-6HE-RK	175	JAT-6673	182	JW-USB	189	M61	Pág.
JAS-6542	178	JAT-6673-RK	182	K	Pág.	M61110	111
JAS-6542-RK	178	JAT-6676	179	KIT AR	185	M61112	111
JAS-6543	178	JAT-6676-RK	179	M01	Pág.	M61113	111
JAS-6543-RK	178	JAT-6904S	183	M01016	110	M61116	111
JAS-6551	173	JAT-6905-C	183	M01020	110	M61119	111
JAS-6551-RK	173	JAT-6905-J	183	M03	Pág.	M61122	111
JAS-6552	173	JAT-6905B	183	M03025	110	M61125	111

M61H116	112	MF05B	112	MSH3814	75	P-EVA(W26134SV)	42
M61H119	112	MF05C	112	MT0	Pág.	P-EVA(W2623431SV)	42
M61H124	112	MF05D	112	MT010001	156	P-T	Pág.
M62	Pág.	MF05E	112	MT010002	156	P-TR (D70SP06ST)	43
M62102	111	MF05S	112	MT010003	156	P-TR (PC303ST)	43
M62103	111	MFM	Pág.	MT010004	156	P-TR (S04H4120ST)	43
M62104	111	MFM06S	112	MT010005	156	P-TR (S04H4506ST)	43
M62105	111	MG0	Pág.	MT010006	156	P-TR (W26107ST)	43
M62106	111	MG010001	154	MT010007	156	P-TR (W26920ST)	43
M62108	111	MG010002	154	MT010008	156	P-TR(AG010002SP)	43
M62H102	112	MG010003	154	MT0201	113	P-TR(AG010026SP)	43
M62H103	112	MG010004	154	MT0703	113	P-TR(AI10002SP)	43
M62H104	112	MG010005	154	MTC	Pág.	P-TR(D70105SP)	43
M62H106	112	MG010006	154	MTC101SP	30	P-TR(D71PP08SP)	43
M63	Pág.	MG010008	154	MTC1150	113	P-TR(H10MB08SP)	43
M63102	111	MG010009	154	MTC1200	113	P-TR(M09513SP)	43
M63103	111	MG020001	155	MTC1300	113	P-TR(M645114SP)	43
M63104	111	MG020003	155	MTC150	113	P-TR(P018SP)	43
M63105	111	MG020004	155	MTC153	113	P-TR(P04704SP)	43
M63106	111	MG020006	155	MTC156	113	P-TR(P0803SP)	43
M63106S	112	MG020007	155	MTC200	113	P-TR(P0903SP)	43
M63108	111	MG020008	155	MTC306	114	P-TR(P2710SP)	43
M63113KV	37	MHS	Pág.	MTC308	114	P-TR(S03A4122SP)	43
M63H103	112	MHS08KV	37	MTC408	114	P-TR(S04H2125SP)	43
M63H105	112	MHS100AG	113	MTC508	114	P-TR(S04H3157SP)	43
M63H106	112	MHS300	113	MTM	Pág.	P-TR(S04H3536SP)	43
M63H108	112	MI1	Pág.	MTM1025	114	P-TR(S04H4125SP)	43
M63M106S	112	MI010014	155	MTM1050	114	P-TR(S04H4524SP)	43
M64	Pág.	MI010016	155	MTM1075	114	P-TR(S04H4726SP)	43
M64105	111	MI010017	155	MTM1100	114	P-TR(S04H4728SP)	43
M64105S	112	MI010018	155	P-B	Pág.	P-TR(S06H427SP)	43
M645114SP	30	MI010019	155	P-B (31)	43	P-TR(S09H4118SP)	43
M64M105S	112	MI010020	155	P-B (41)	43	P-TR(S29H4140SP)	43
ME0	Pág.	MI010021	155	P-E	Pág.	P-TR(W23108SP)	43
ME010001	154	MI020001	155	P-EVA(D70105KV)	41	P-TR(W25110SP)	43
ME010007	154	MI020002	155	P-EVA(D71PP08KV)	41	P-TR(W26112SP)	43
ME010009	154	MI020004	155	P-EVA(D737128SV)	41	P-TR(W26116SP)	43
ME010010	154	MK2	Pág.	P-EVA(D737134SV)	41	P01	Pág.
ME010012	154	MK2040	113	P-EVA(H10121SV)	41	P0118	90
ME020001	154	MK2040-B	113	P-EVA(H10MB08KV)	41	P011804KV	37
ME020002	154	MK2080	113	P-EVA(H10MT08KV)	41	P018	88
ME020003	154	MKS	Pág.	P-EVA(M09103KV)	41	P018SP	30
ME020005	154	MKS27	113	P-EVA(M63113KV)	41	P018SP1	30
ME020006	154	MKS27-12	113	P-EVA(MHS08KV)	41	P03	Pág.
MEC	Pág.	MKS27-16	113	P-EVA(P32M105KV)	41	P038	88
MEC PESADOS 20A	17	MKS27-16A	113	P-EVA(P82714SV)	41	P04	Pág.
MEC PESADOS 20B	17	MKS27-20	113	P-EVA(P82736SV)	41	P046	88
MEC POWER 19C	9	MKV	Pág.	P-EVA(S03A4122KV)	42	P04704SP	30
MEC POWER 19V	9	MKV7	116	P-EVA(S04A4122KV)	42	P05	Pág.
MEC PROF20-BLACK	10	MKV7-K	116	P-EVA(S04H2132KV)	42	P0516	90
MEC PROF20-C	10	MKV8	116	P-EVA(S04H4144KV)	42	P0518	90
MEC PROF20-V	10	MNO	Pág.	P-EVA(S04H42165SV)	42	P06	Pág.
MEC SOLUTION BLACK	8	MNO20004	155	P-EVA(S04H4295SV)	42	P068	88
MEC SOLUTION-C	8	MNO20005	156	P-EVA(S04H45121SV)	42	P068A	88
MEC SOLUTION-V	8	MSH	Pág.	P-EVA(S29H4141KV)	42	P07	Pág.
MFO	Pág.	MSH1214	75	P-EVA(W23559SV)	42	P079	88
MF05A	112	MSH1414	75	P-EVA(W25110KV)	42		
				P-EVA(W26116KV)	42		

P08	Pág.	P32	Pág.	P7603	92	PV2	Pág.
P0803SP	30	P32M03S	95	P7608	92	PV28110	117
P08104S	91	P32M05C	94	P77	Pág.	PV4	Pág.
P0813SC	39	P32M07A	93	P7719	92	PV4006	117
P0816	90	P32M105KV	37	P78	Pág.	R12	Pág.
P0817	90	P32M10A	93	P7801	95	R1206N	45
P0818	90	P32M10C	94	P7802	95	R1206N-R	47
P09	Pág.	P36	Pág.	P7803	95	R1206R	47
P0903SP	30	P36M01P	93	P7804	95	R12081	45
P0916	90	P36M02P	93	P7805	95	R12081RK	47
P0917	90	P36M06C	95	P78M10C	95	R19	Pág.
P0918	90	P36M09A	93	P80	Pág.	R19H310S	78
P10	Pág.	P36M09C	95	P8006	89	R19H3110	78
P1016	90	P37	Pág.	P81	Pág.	R19H3111	78
P1017	90	P37M11A	94	P8106	89	R19H3112	78
P1019	94	P37M18A	94	P82	Pág.	R19H3113	78
P11	Pág.	P38	Pág.	P82714SV	34	R19H3114	78
P1116	90	P38M09A	94	P82736SV	34	R19H3115	78
P1118	90	P38M11A	94	P86	Pág.	R19H3116	78
P12	Pág.	P40	Pág.	P8606	89	R19H3117	78
P1216	90	P4016	90	P90	Pág.	R19H3118	78
P1218	90	P43	Pág.	P9006	89	R19H3119	78
P14	Pág.	P4318	91	P94	Pág.	R29	Pág.
P1416	90	P4318-RK	92	P9409	94	R2902	46
P15	Pág.	P4330	91	P95	Pág.	R2902RK	47
P1516	90	P4330-RK	92	P9506	88	R2903RK	47
P15808	91	P52	Pág.	P9508C	89	R2904	46
P17	Pág.	P52A10	94	P9508D	89	R2904RK	47
P178	91	P52B10	94	P96	Pág.	R34	Pág.
P18	Pág.	P52C10	94	P9601	113	R3402RK	47
P1810	91	P52D12	94	P99	Pág.	R3403	46
P20	Pág.	P52M10	94	P9902S	89	R3403RK	47
P2010LA	91	P52N10	94	PES	Pág.	R3404RK	47
P2010RA	91	P53	Pág.	PESD05	91	R35	Pág.
P2010SA	91	P53M06	94	PESD10	91	R3502	46
P22	Pág.	P53M11	94	PESD11	91	R3503	46
P2205E	91	P53M18	94	PIN	Pág.	R3504	46
P2208A	91	P54	Pág.	PINTOR20-BLACK	16	R36	Pág.
P2212A	91	P54M08A	94	PINTOR20-C	16	R3602	46
P26	Pág.	P54M10A	94	PINTOR20-V	16	R3602RK	47
P266	88	P60	Pág.	PSV	Pág.	R3603	46
P27	Pág.	P6008	88	PSV110SC	117	R3603RK	47
P2706	88	P61	Pág.	PSV218SP	117	R3604RK	47
P2710	88	P6106	88	PV0	Pág.	R37	Pág.
P2710SP	30	P6108	88	PV0118	116	R3702	46
P2712	88	P6116	90	PV0518	116	R3702B	46
P28	Pág.	P64	Pág.	PV0816	116	R3703	46
P2803SP	31	P6424	92	PV0817	116	R3704	46
P2810	88	P71	Pág.	PV0918	116	R3704B	46
P28110	90	P7101	89	PV1	Pág.	R41	Pág.
P28112	90	P7102	89	PV1016	116	R4103	46
P28112	90	P7103	89	PV1116	116	R4104	46
P28210	91	P7104	89	PV1118	116	R45	Pág.
P28212	91	P7105	89	PV1218	116	R4502	46
P30	Pág.	P76	Pág.	PV1416	116	R4502JRK	47
P30M07C	94	P7601	92	PV1516	116	R4502RK	47
P30M10A	93	P7602	92				

R48	Pág.	S03A	Pág.				
R4802	46	S03A2110	79	S03A6145	81	S03A8E04	83
R4802A	46	S03A2112	79	S03A6146	81	S03A8E07	83
R4802B	46	S03A2114	79	S03A6147	81	S03A8E10	83
R4802RK	47	S03A2UT	79	S03A6148	81	S03AD	Pág.
R4803	46	S03A3UT	79	S03A6149	81	S03AD4110	80
R4804	46	S03A4109	80	S03A6150	81	S03AD4111	80
R4804A	46	S03A4110	80	S03A6151	81	S03AD4111S	79
R4804B	46	S03A4111	80	S03A6152	81	S03AD4112	80
R4804RK	47	S03A4111S	78	S03A6153	81	S03AD4113	80
R4811SC	39	S03A4112	80	S03A6154	81	S03AD4114	80
R51	Pág.	S03A4112	80	S03A6155	81	S03AD4115	80
R5103	47	S03A4113	80	S03A6156	81	S03AD4116	80
R5103RK	47	S03A4114	80	S03A6157	81	S03AD4117	80
R5104	47	S03A4115	80	S03A6158	81	S03AD4118	80
R5104RK	47	S03A4116	80	S03A6159	81	S03AD4119	80
R53	Pág.	S03A4117	80	S03A6160	81	S03AD4120	80
R53A-2A	78	S03A4118	80	S03A6163	81	S03AD4121	80
R53A-3A	78	S03A4119	80	S03A6165	81	S03AD4122	80
R53A-4A	78	S03A4120	80	S03A6167	81	S03AD4123	80
R58	Pág.	S03A4121	80	S03A6170	81	S03AD4124	80
R5802ERK	47	S03A4122	80	S03A6A4	82	S03AD4125	80
R5803RK	47	S03A4122KV	37	S03A6A8	82	S03AD4126	80
R5804ERK	47	S03A4122SP	31	S03A6E04	82	S03AD4127	80
R5804LRK	47	S03A4123	80	S03A6E08	82	S03AD4128	80
R66	Pág.	S03A4124	80	S03A6E10	82	S03AD4130	80
R6602	47	S03A4127	80	S03A6U6	82	S03AD4132	80
R6603	47	S03A4129	80	S03A8109S	83	S03AD4303S	86
R6604	47	S03A4130	80	S03A8124	83	S03AD4307S	86
R68	Pág.	S03A4132	80	S03A8127	83	S03AD4317	86
R6802	47	S03A4211S	79	S03A8129	83	S03AD4319	86
R6802RK	47	S03A4A3	79	S03A8130	83	S03AD4321	86
R6803	47	S03A4A6	79	S03A8132	83	S03AD4414S	79
R6803RK	47	S03A4E4	79	S03A8133	83	S03AD4503S	86
R6804	47	S03A4E5	79	S03A8134	83	S03AD4517	87
R6804RK	47	S03A4E6	79	S03A8135	83	S03AD4519	87
RD0	Pág.	S03A4E8	79	S03A8136	83	S03AD4521	87
RD01	47	S03A4U4	79	S03A8138	83	S03AD6107S	82
RD01032S	101	S03A4UT	79	S03A8140	83	S03AD6120S	82
RD01032S	101	S03A4UT3S	79	S03A8141	83	S03AD6124	82
RD02	47	S03A6108S	81	S03A8144	83	S03AD6126	82
RD05H2	102	S03A6126	81	S03A8146	83	S03AD6127	82
RV0	Pág.	S03A6127	81	S03A8150	83	S03AD6129	82
RV032	119	S03A6129	81	S03A8155	83	S03AD6130	82
RV033	119	S03A6130	81	S03A8160	83	S03AD6132	82
RV034	119	S03A6132	81	S03A8165	83	S03AD6133	82
S01U	Pág.	S03A6133	81	S03A8170	83	S03AD6134	82
S01U4108S	79	S03A6134	81	S03A8173	83	S03AD6135	82
S01U4113	79	S03A6135	81	S03A8175	83	S03AD6136	82
S01U4114	79	S03A6136	81	S03A8176	83	S03AD6138	82
S01U4115	79	S03A6137	81	S03A8178	83	S03AD6140	82
S01U4116	79	S03A6138	81	S03A8180	83	S03AD6141	82
S01U4117	79	S03A6139	81	S03A8185	83	S03AD6142	82
S01U4119	79	S03A6140	81	S03A8189	83	S03AD6144	82
S01U4121	79	S03A6141	81	S03A8190	83	S03AD6146	82
S01U4122	79	S03A6142	81	S03A8192	83	S03AD6150	82
		S03A6143	81	S03A8195	83	S03AD8107S	83
		S03A6144	81	S03A8A6	83	S03AD8117	84

S03AD8124	84	S03V4127	117	S04H4119	64	S04H6327	66
S03AD8126	84	S03V4132	117	S04H4120	64	S04H6329	66
S03AD8127	84	S04H	Pág.	S04H4121	64	S04H6330	66
S03AD8129	84	S04H2104	63	S04H4122	64	S04H6332	66
S03AD8130	84	S04H2104S	63	S04H4123	64	S04H6334	66
S03AD8132	84	S04H2105	63	S04H4124	64	S04H6336	66
S03AD8133	84	S04H2105S	63	S04H4125	64	S04H6338	66
S03AD8134	84	S04H2106	63	S04H4125S	59	S04H6341	66
S03AD8135	84	S04H2107	63	S04H4125SP	31	S04H6346	66
S03AD8136	84	S04H2108	63	S04H4126	64	S04H6350	66
S03AD8138	84	S04H2109	63	S04H4127	64	S04H6355	66
S03AD8140	84	S04H2110	63	S04H4128	64	S04H6356	66
S03AD8141	84	S04H2111	63	S04H4129	64	S04H6360	66
S03AD8142	84	S04H2112	63	S04H4130	64	S04H6365	66
S03AD8146	84	S04H2113	63	S04H4131SP	32	S04H6419	66
S03AD8148	84	S04H2114	63	S04H4132	64	S04H6421	66
S03AD8150	84	S04H2118S	58	S04H4134	64	S04H6422	66
S03AD8155	84	S04H2125SP	31	S04H4136	64	S04H6424	66
S03AD8158	84	S04H2132KV	38	S04H4144KV	38	S04H6426	66
S03AD8160	84	S04H2141S	58	S04H42165SV	35	S04H6427	66
S03AD8165	84	S04H2184SV	35	S04H4295SV	35	S04H6429	66
S03H	Pág.	S04H3106	63	S04H4524S	59	S04H6430	66
S03H2327S	58	S04H3107	63	S04H4524SP	32	S04H6432	66
S03S	Pág.	S04H3108	63	S04H46121SV	35	S04H6433	66
S03S8117	84	S04H3109	63	S04H4726SP	32	S04H6435	66
S03S8119	84	S04H3110	63	S04H4728S	59	S04H6436	66
S03S8121	84	S04H3111	63	S04H4728SP	32	S04H6438	66
S03S	Pág.	S04H3112	63	S04H5129SC	40	S04H6440	66
S03SD8117	84	S04H3113	63	S04H524127S	62	S04H6441	66
S03SD8119	84	S04H3114	63	S04H52460S	61	S04H6443	66
S03SD8121	84	S04H3115	63	S04H52477S	61	S04H6444	66
S03V	Pág.	S04H3116	63	S04H52478S	61	S04H6446	66
S03V2106	117	S04H3117	63	S04H6115S	59	S04H6447	66
S03V2108	117	S04H3118	63	S04H6119	65	S04H6450	66
S03V2110	117	S04H3119	63	S04H6121	65	S04H6456	66
S03V2114	117	S04H3120	63	S04H6122	65	S04H8115S	59
S03V3108	117	S04H3121	63	S04H6124	65	S04H8355	67
S03V3110	117	S04H3122	63	S04H6127	65	S04H8360	67
S03V3112	117	S04H3124	63	S04H6128	65	S04H8365	67
S03V3113	117	S04H3125S	58	S04H6130	65	S04HD	Pág.
S03V3114	117	S04H3141S	58	S04H6132	65	S04HD2105	63
S03V3116SC	117	S04H3157S	58	S04H6134	65	S04HD2106	63
S03V3117	117	S04H3157SP	31	S04H6136	65	S04HD2107	63
S03V3119	117	S04H3194SV	35	S04H6138	65	S04HD2108	63
S03V3122	117	S04H3536S	59	S04H6141	65	S04HD2109	63
S03V3136SV	118	S04H3536SP	31	S04H6146	65	S04HD2110	63
S03V4110	117	S04H4108	64	S04H6150	65	S04HD2111	63
S03V4111	117	S04H4109	64	S04H6152	65	S04HD2112	63
S03V4112	117	S04H4110	64	S04H624101S	62	S04HD2113	63
S03V4113	117	S04H4111	64	S04H6319	66	S04HD3109	64
S03V4114	117	S04H4112	64	S04H6321	66	S04HD3110	64
S03V4117	117	S04H4113	64	S04H6321S	59	S04HD3111	64
S03V4119	117	S04H4114	64	S04H6322	66	S04HD3112	64
S03V4120SC	118	S04H4115	64	S04H6323	66	S04HD3113	64
S03V4122	117	S04H4116	64	S04H6324	66	S04HD3114	64
S03V4124	117	S04H4117	64	S04H6325	66	S04HD3115	64
S03V4124SV	118	S04H4118	64	S04H6326	66	S04HD3116	64

S04HD3117	64	S05HD4118	67	S07H	Pág.	S09H206	71
S04HD3119	64	S05HD4119	67	S07H206	70	S09H207	71
S04HD3120	64	S05HD4120	67	S07H207	70	S09H303	71
S04HD3121	64	S05HD4121	67	S07H208	70	S09H304	71
S04HD3124	64	S05HD4122	67	S07H209	70	S09H305	71
S04HD4109	65	S05HD4123	67	S07H210	70	S09H306	71
S04HD4110	65	S05HD4124	67	S07H2138KV	38	S09H307	71
S04HD4111	65	S05HD4127	67	S07H215	70	S09H308	71
S04HD4112	65	S05HD4130	67	S07H220	70	S09H310	71
S04HD4113	65	S05HD4132	67	S07H225	70	S09H312	71
S04HD4114	65	S05HD4213S	67	S07H227	70	S09H314	71
S04HD4115	65	S06A	Pág.	S07H230	70	S09H404	72
S04HD4116	65	S06A408S	85	S07H240	70	S09H405	72
S04HD4117	65	S06A4T20	85	S07H310	70	S09H406	72
S04HD4118	65	S06A4T27	85	S07H315	70	S09H407	72
S04HD4119	65	S06A4T30	85	S07H320	70	S09H408	72
S04HD411S	65	S06A4T40	85	S07H325	70	S09H410	72
S04HD4120	65	S06A4T45	85	S07H327	70	S09H4109S	60
S04HD4121	65	S06A4T50	85	S07H330	70	S09H4118SP	32
S04HD4122	65	S06A4T55	85	S07H340	70	S09H412	72
S04HD4123	65	S06A4T60	85	S07H345	70	S09H414	72
S04HD4124	65	S06A4T70	85	S07H350	70	S09H416	72
S04HD4125	65	S06A4T80	85	S07H355	70	S09H417	72
S04HD4126	65	S06H	Pág.	S07H360	70	S09H419	72
S04HD4127	65	S06H204	69	S07H4109S	60	S09H4304	72
S04HD4128	65	S06H205	69	S07H420	70	S09H4305	72
S04HD4130	65	S06H206	69	S07H425	70	S09H4306	72
S04HD4132	65	S06H207	69	S07H427	70	S09H4307	72
S05A	Pág.	S06H208	69	S07H430	70	S09H4308	72
S05A408S	85	S06H210	69	S07H4320	71	S09H4309	72
S05A4H10	84	S06H211	69	S07H4325	71	S09H4310	72
S05A4H12	84	S06H306	69	S07H4327	71	S09H4312	72
S05A4H14	84	S06H307	69	S07H4330	71	S09H4314	72
S05A4H17	84	S06H308	69	S07H4340	71	S09H4316	72
S05A4H18	84	S06H310	69	S07H4345	71	S09H4317	72
S05A4H19	84	S06H311	69	S07H4350	71	S09H4319	72
S05A4H4	84	S06H312	69	S07H4352	71	S09V	Pág.
S05A4H5	84	S06H314	69	S07H4355	71	S09V3H4	118
S05A4H6	84	S06H316	69	S07H4360	71	S09V3H5	118
S05A4H7	84	S06H318	69	S07H4370	71	S09V3H6	118
S05A4H8	84	S06H320	69	S07H440	70	S09V3H8	118
S05A6105S	85	S06H325	67	S07H445	70	S09V41H10	118
S05A6H14	85	S06H410	69	S07H450	70	S09V41H4	118
S05A6H17	85	S06H411	69	S07H4530	71	S09V41H5	118
S05A6H19	85	S06H412	69	S07H4540	71	S09V41H6	118
S05A6H22	85	S06H4127S	60	S07H4545	71	S09V41H8	118
S05A6H24	85	S06H414	69	S07H455	70	S10H	Pág.
S05H	Pág.	S06H416	69	S07H460	70	S10H230	72
S05H4113S	67	S06H418	69	S07H470	70	S10H235	72
S05H4213S	67	S06H420	69	S07H4932S	60	S10H240	72
S05HD4110	67	S06H422	69	S08H	Pág.	S10H245	72
S05HD	Pág.	S06H424	69	S08H208S	101	S10H250	72
S05HD4111	67	S06H425S	59	S08H311S	71	S10H255	72
S05HD4112	67	S06H427KV	38	S09H	Pág.	S10H260	72
S05HD4113	67	S06H427SP	32	S09H203	71	S10H270	72
S05HD4113S	67	S06H49S	67	S09H204	71	S10H3100	73
S05HD4117	67			S09H205	71	S10H3120	73

S10H340	73	S18A	Pág.	S25V410	118	S49H4312	74
S10H350	73	S18A4103MS	86	S25V45	118	S49H4314	74
S10H355	73	S18A4115	86	S26H	Pág.	S49H4318	74
S10H360	73	S18A4117	86	S26H2150	77	S50H	Pág.
S10H370	73	S18A4117M	86	S26H2280	77	S50H3106S	74
S10H380	73	S18A4119	86	S27H	Pág.	S50H3206S	74
S10H4100	73	S18A4119M	86	S27H2	77	S54H	Pág.
S10H4110	73	S18A4121	86	S27H3	77	S54H5509S	74
S10H4120	73	S18A4121M	86	S27H4	77	S57H	Pág.
S10H480	73	S18AD	Pág.	S29H	Pág.	S57H108	53
S10H490	73	S18AD4117	86	S29H2133S	102	S57H108S	53
S11H	Pág.	S18AD4119	86	S29H2180S	105	S57H109	53
S11H200	73	S18AD4121	86	S29H4140SP	32	S57H110	53
S11H201	73	S21H	Pág.	S29H4141KV	38	S57H111	53
S11H202	73	S21H41125	76	S29T	Pág.	S57H112	53
S11H203	73	S21H41250	76	S29TP23S	102	S57H113	53
S11H300	73	S21H4150	76	S40H	Pág.	S57H115	53
S11H301	73	S21H4175	76	S40H108	77	S57H116	53
S11H302	73	S22H	Pág.	S40H110	77	S57H117	53
S11H303	73	S22H21130	76	S40H112	77	S57H118	53
S11H304	73	S22H21130RK	76	S40H114	77	S57H119	53
S11H402	73	S22H31200	76	S40T	Pág.	S57H121	53
S11H403	73	S22H41375	76	S40T108	77	S57H122	53
S11H404	73	S22H41375RK	76	S40T109S	77	S57H123	53
S12A	Pág.	S22H41450	76	S40T110	77	S57H124	53
S12A4525S	85	S22H41600	76	S40T112	77	S57H125	53
S14A4108S	102	S22H41600RK	76	S40T113	77	S57H127	53
S14A4117	102	S22H6500	76	S40T114	77	S57H132	53
S14A4118	102	S22H6500RK	76	S40T117	77	S60H	Pág.
S14A4120	102	S23H	Pág.	S40T119	77	S60H4304S	78
S14A4121	102	S23H21115	77	S41H	Pág.	S63H	Pág.
S14A4123	102	S23H31200	77	S41H41	77	S63H3306	74
S14A4124	102	S23H41250	77	S42M	Pág.	S63H3307	74
S14A4126	102	S23H41300	77	S42M403S	78	S63H3308	74
S14A4127	102	S23H6450	77	S42M4125	78	S63H3310	74
S15H	Pág.	S23H6500	77	S42M4250	78	S63H4306	74
S15H240	75	S23H8550	77	S42M475	78	S63H4307	74
S15H356	75	S24H	Pág.	S43V	Pág.	S63H4308	74
S15H472	75	S24H2100	77	S43V38	119	S63H4310	74
S15H6109	75	S24H2150	77	S43V48	119	S63H4312	74
S16H	Pág.	S24H250	77	S44H	Pág.	S63H4313	74
S16H1234	76	S24H3150	77	S44H2206	78	S63H4405	74
S16H1238	76	S24H3200	77	S44H3110A	78	S63H4405	74
S16H1438	76	S24H3250	77	S44H3206	78	S63H4407	74
S16H302	76	S24H375	77	S44H4110	78	S63H4407	74
S16H304	76	S24H4125	77	S46T	Pág.	S63H4408	74
S16H3410	76	S24H4224	77	S46TE80	87	S63H4408	74
S16H3412	76	S24H4250	77	S49H	Pág.	S63H4409	74
S16H3812	76	S24H450	77	S49H4105	74	S63H4409	74
S16H3814	76	S24H475	77	S49H4106	74	S63H4410	74
S16H403	76	S24H6100	77	S49H4108	74	S63H4410	74
S17H	Pág.	S24H6200	77	S49H4110	74	S63H4412	74
S17H3116	76	S24H6400	77	S49H4112	74	S63H4412	74
S17H3121	76	S24H8200	77	S49H4114	74	S63H4413	74
S17H3414	76	S25V	Pág.	S49H4116	74	S63H4413	74
S17H4116	76	S25V310	118	S49H4308	74	S63H4414	74
S17H4121	76	S25V36	118	S49H4310	74	S63H4414	74

S63H4507S	74	S64H4712	75	S68H2108	56	T21340N-R	45
S63H4605	74	S64H4714	75	S68H2109	56	T21341N	44
S63H4606	74	S64H4808	75	S68H2110	56	T21341N-R	45
S63H4607	74	S64H4810	75	S68H2111	56	T21550N	44
S63H4608	74	S64H4812	75	S68H2112	56	T21550N-R	45
S63H4609	74	S64H4814	75	S68H2113	56	T24	Pág.
S63H4610	74	S66H	Pág.	S68H2114	56	T24135	45
S63H4612	74	S66H4108	68	S68H2141S	56	T24135-R	45
S63H4613	74	S66H4110	68	S68H5234111S	57	T24200	45
S63H4614	74	S66H4111	68	T04	Pág.	T24200-R	45
S63H4708	75	S66H4112	68	T04M060-R	45	T25	Pág.
S63H4709	75	S66H4113	68	T04M061-R	45	T25100N	44
S63H4710	75	S66H4114	68	T04M150-R	45	T25100N-R	45
S63H4712	75	S66H4115	68	T04M250-R	45	T25200N	44
S63H4713	75	S66H4116	68	T07	Pág.	T25200N-R	45
S63H4714	75	S66H4117	68	T07030N-R	45	T25340N	44
S63H4808	75	S66H4118	68	T07110N-R	45	T25340N-R	45
S63H4809	75	S66H4119	68	T07700N-R	45	T27	Pág.
S63H4810	75	S66H4120	68	T09	Pág.	T27-D2R	45
S63H4812	75	S66H4121	68	T094602	47	T27-D3R	45
S63H4813	75	S66H4122	68	T094602-RK	47	T27-D4R1	45
S63H4814	75	S66H4124	68	T096801	47	T27-D4R2	45
S64A	Pág.	S66H4125	68	T096801-RK	47	T27-D6R	45
S64A4106S	85	S66H4126	68	T10	Pág.	T27-D8R	45
S64A6116	85	S66H4127	68	T102001S-R	45	T27010N	44
S64A6118	85	S66H4128	68	T10314	44	T27020N	44
S64A6306S	85	S66H4130	68	T10315	44	T27060N	44
S64A6T100	85	S66H4132	68	T10316	44	T271001N	44
S64A6T70	85	S66H4136	68	T10317	44	T27101N	44
S64A6T80	85	S66HD	Pág.	T10318	44	T27200N	44
S64A6T90	85	S66HD4110	68	T10319	44	T27340N	44
S64H	Pág.	S66HD4111	68	T10321	44	T27800N	44
S64H4104	75	S66HD4112	68	T10322	44	T29	Pág.
S64H4105	75	S66HD4113	68	T10H1210S	44	T29002	44
S64H4106	75	S66HD4114	68	T14	Pág.	T29014	44
S64H4107	75	S66HD4115	68	T14200N	45	T29016	44
S64H4109	75	S66HD4116	68	T15	Pág.	T30	Pág.
S64H4112	75	S66HD4117	68	T154100N-R	45	T30200NS	44
S64H4113	75	S66HD4118	68	T154200N-R	45	T31	Pág.
S64H4114	75	S66HD4119	68	T16	Pág.	T31313	44
S64H4126S	61	S66HD4120	68	T16005N-R	45	T31324	44
S64H4204	75	S66HD4121	68	T19	Pág.	T33	Pág.
S64H4205	75	S66HD4122	68	T19135N	45	T33025N	44
S64H4206	75	S66HD4123	68	T19200N	45	T33025N-R	45
S64H4207	75	S66HD4124	68	T19600N	45	T33050N	44
S64H4208	75	S66HD4127	68	T21	Pág.	T33050N-R	45
S64H4209	75	S66HD4130	68	T21025N	44	T33101N	44
S64H4210	75	S66HD4132	68	T21025N-R	45	T33101N-R	45
S64H4212	75	S68H	Pág.	T21050N	44	T33200N-R	45
S64H4214	75	S68H2103	56	T21050N-R	45	T33341N	44
S64H4216	75	S68H2104	56	T211000N	44	T33341N-R	45
S64H4218	75	S68H2104S	56	T211000N-R	45	T35	Pág.
S64H4705	75	S68H2105	56	T21101N	44	T351060	47
S64H4706	75	S68H2105S	56	T21101N-R	45	V10	Pág.
S64H4708	75	S68H2106	56	T21200N	44	V1001	92
S64H4709	75	S68H2106S	56	T21200N-R	45	V1002	92
S64H4710	75	S68H2107	56	T21340N	44	V1002-RK	92

V1003	92	W232427	51	W251618	52	W26125	52
V1003-RK	92	W232528	51	W251719	52	W26126	52
V1005	92	W233032	51	W251819	52	W26126S	52
V11	Pág.	W23559SV	36	W251922	52	W26127	52
V11011SC	40	W23V108	119	W252022	52	W26128	52
V1103	92	W23V110	119	W252123	52	W26129	52
V13	Pág.	W23V111	119	W252224	52	W26130	52
V1310A-11	93	W23V112	119	W252426	52	W26132	52
V1310B-11	93	W23V113	119	W252427	52	W26134	52
V1310E-11	93	W23V114	119	W252528	52	W26134SV	36
V1310F	93	W23V116	119	W252730	52	W26136	52
V1310F-11	93	W23V117	119	W252732	52	W26138	52
V1310G-11	93	W23V118	119	W253032	52	W26141	52
V1310J-11	93	W23V119	119	W253236	52	W26142	52
V1311A	93	W23V121	119	W253641	52	W26144	52
V1311C	93	W23V122	119	W253842	52	W26146	52
V1311E	93	W23V124	119	W254146	52	W26148	52
V1311SP	33	W24	Pág.	W254650	52	W26150	52
V14	Pág.	W240809	51	W25V108	119	W26155	52
V1401	93	W241011	51	W25V109	119	W26160	52
V1403	93	W241012	51	W25V110	119	W26165	52
V15	Pág.	W24106S	51	W25V1125SV	119	W2623431SV	36
V1501	93	W241213	51	W25V113	119	W26315SV	36
V1505	93	W241214	51	W25V114	119	W26411PRS	53
V21	Pág.	W241314	51	W25V117	119	W26414S	53
V2101	92	W241417	51	W25V118	119	W27	Pág.
V2102	92	W241617	51	W25V119	119	W27AK8	55
V2102-RK	92	W241719	51	W25V121	119	W27AL10	55
V24	Pág.	W241819	51	W25V122	119	W27AR10	55
V2401	92	W241922	51	W25V124	119	W27AR8	55
V2401-M10A	93	W242224	51	W26	Pág.	W27AS10	55
V2401-M10B	93	W242427	51	W26106	52	W27AS15	55
V2401-M5A	93	W242528	51	W26107	52	W27AS18	55
V2401-M5B	93	W243032	51	W26108	52	W27AS8	55
V2401-M6A	93	W24A107S	48	W26108KV	39	W27AT02SC	40
V2401-M6B	93	W24A109SP	33	W26109	52	W27AT10	55
V2401-M8A	93	W24N0810	51	W26110	52	W27AT12	55
V2401-M8B	93	W24N1113	51	W26110KV	39	W27AT15	55
W23	Pág.	W24N1214	51	W26111	52	W27AT8	55
W230607	51	W24N1719	51	W26112	52	W28	Pág.
W230809	51	W25	Pág.	W26112S	52	W2808	56
W230810	51	W250607	52	W26112SP	33	W2810	56
W231011	51	W250608	52	W26113	52	W2810RJ-HL	56
W23108S	51	W250809	52	W26114	52	W2812	56
W23108SP	33	W251011	52	W26114S	52	W2812RJ-HL	56
W231113	51	W251012	52	W26115	52	W2814	56
W231213	51	W25106KV	38	W26116	52	W2814RJ-HL	56
W231317	51	W25107KV	38	W26116KV	39	W2818	56
W231415	51	W25108S	52	W26116SP	33	W2818RJ-HL	56
W231617	51	W25110KV	39	W26117	52	W2824	56
W231719	51	W25110SP	33	W26118	52	W2824RJ-HL	56
W231819	51	W25117SC	40	W26119	52	W2836	56
W231922	51	W251213	52	W26120	52	W2836RJ-HL	56
W232022	51	W251214	52	W26121	52	W28HD8	56
W232123	51	W251415	52	W26122	52	W29	Pág.
W232224	51	W251417	52	W26123	52	W290608	53
W232426	51	W251617	52	W26124	52	W290711	53

W291012	53	W61	Pág.	W67124	54	W77A155	54
W291418	53	W611011	50	W67130	54	W77A160	54
W291622	53	W61106S	50	W67132	54	W77A165	54
W292024	53	W611214	50	W67136	54	W77H01	54
W39	Pág.	W611315	50	W67138	54	W77H02	54
W391011	53	W611618	50	W67141	54	W77H03	54
W39108SA	53	W611719	50	W67145	54	W77H04	54
W391213	53	W612224	50	W67146	54	W84	Pág.
W391415	53	W62	Pág.	W67150	54	W84106	57
W391617	53	W6210607	50	W67155	54	W84107	57
W391819	53	W6210809	50	W67160	54	W84108	57
W43	Pág.	W62108S	51	W67165	54	W84108S	57
W43A0607	54	W6211011	50	W67170	54	W84109	57
W43A0809	54	W6211213	50	W68	Pág.	W84110	57
W43A1011	54	W6211415	50	W680809	49	W84111	57
W43A106S	54	W6211617	50	W680810	49	W84112	57
W43A1213	54	W6211819	50	W681011	49	W84113	57
W43A1415	54	W6212022	50	W68106S	49	W84114	57
W43A1617	54	W6212427	50	W681213	49	W84114S	57
W43A1819	54	W6212528	50	W681415	49	W84115	57
W45	Pág.	W6213032	50	W681618	49	W84116	57
W45108	48	W65	Pág.	W681719	49	W84117	57
W45109	48	W65105KV	39	W69	Pág.	W84118	57
W45110	48	W6510810	53	W69116S	53	W84119	57
W45110S	48	W6511012	53	W70	Pág.	W86112S	57
W45111	48	W6511315	53	W70A118S	33	W91	Pág.
W45112	48	W6511417	53	W72	Pág.	W91107S	50
W45112SP	33	W6511922	53	W72117	55	W91110	50
W45113	48	W65A1012	54	W72118	55	W91112	50
W45114	48	W65A105S	54	W72119	55	W91113	50
W45115	48	W65A1214	54	W72121	55	W91114	50
W45116	48	W65A1315	54	W72122	55	W91115	50
W45117	48	W65A1618	54	W72124	55	W91117	50
W45117S	48	W65A1719	54	W72127	55	W91119	50
W45118	48	W65A1922	54	W72130	55	W93	Pág.
W45119	48	W65A2224	54	W72132	55	W93108S	50
W45121	48	W66	Pág.	W72134	55	W93110	50
W45122	48	W66107S	49	W72136	55	W93111	50
W45124	48	W66108	49	W72141	55	W93112	50
W45127	48	W66109	49	W72146	55	W93113	50
W45130	48	W66110	49	W72150	55	W93114	50
W45132	48	W66111	49	W72155	55	W93115	50
W45316S	48	W66112	49	W72170	55	W93117	50
W45316S-AD	48	W66113	49	W73	Pág.	W93119	50
W45316S-AD12	48	W66114	49	W73102S	50	WFS	Pág.
W45316S-AD14	48	W66115	49	W7310813	49	WFS46	54
W45316S-AD34	48	W66116	49	W7311419	49	WV2	Pág.
W45316S-AD38	48	W66116S	49	W77	Pág.	WV27AS10	119
W45316S-ADBH14	48	W66117	49	W77A124	54		
W47	Pág.	W66118	49	W77A127	54		
W47108SP	33	W66119	49	W77A130	54		
W51	Pág.	W66121	49	W77A132	54		
W51110S	49	W66124	49	W77A136	54		
W52	Pág.	W67	Pág.	W77A138	54		
W52105S	49	W67104S	49	W77A141	54		
W60	Pág.	W67119	54	W77A146	54		
W60115SP	33	W67121	54	W77A150	54		

ARTIGO	PÁG.	ARTIGO	PÁG.
Acessórios de ar comprimido	183 a 185	Chave de velas	76, 139
Acessórios para carros ferramenta	24	Chave inglesa	55
Alavancas de chapeiro	158	Chave luneta	50, 51, 54
Alicate anéis de segurança	136	Chave mista	52, 53
Alicate ajustável	88, 89, 91	Chave com roquete	48 a 50
Alicate anti estático	91	Chave para bujão óleo	136, 138, 140
Alicate corta cabos	91, 92	Chave pata de galo	78
Alicate de cravar terminais	93	Chaves alternador	131
Alicate de descarnar	90, 93	Chave cavilhas e encaixes plásticos	157, 158
Alicate de freios	88, 89	Chaves de caixa	63 a 69
Alicate de pressão	93 a 95	Chaves de fenda	96 a 100
Alicate de rebitar	92	Chaves de filtros	136 a 139
Alicate para abraçadeiras	143, 146	Chaves de impacto	78 a 87
Alicates (universal, pontas, corte)	88 a 90	Chaves de velas incandescência	134
Alicates para tubos	136, 141, 143, 146	Chaves dinamométricas	44 e 45
Alicate para tubos escape	143	Chaves em L hexagonais	105 a 109
Alicate para tubos radizador	146	Chaves em L Torx	106 a 109
Alicate tensor abraçadeiras	143	Chaves em T com ponta flexível	77
Alicates travões	142	Chave flexível de punho	77
Apalpa folgas	140	Chaves Phillips	96 a 100
Aparafusadora pneumática	170, 171	Chaves Pozi	98 a 100
Armários oficinais	18 a 20	Chave remoção frisos/ plásticos	156, 157
Aparadeira óleo	122 e 197	Chave remoção vidros/ pábrabras	156
Assentador pneumático de válvulas	178	Chaves retirar fêmeas danificadas	102, 133 e 145
Balanceiros	182	Chave de rodas em cruz	128
Bancada de trabalho	197	Chaves sensor oxigénio	139
Banco de apoio	195	Chaves SuperTech	56, 57
Bandeja magnética	127	Chaves Torx	97, 98
Berbequim pneumático	169, 170	Chaves Torx plus	99
Bits de caixa	69 a 75	Chave para terminais	131
Bits e porta bits	101 a 105	Compasso	114
Bomba de massa	182	Compressor molas	125
Bomba hidropneumática	194	Corta tubos	143, 145
Cabo articulado (rabo de força)	76	Cunhas chapeiro	158
Cabo T corrediço	77	Densímetro	145
Cabos arranque de bateria	23	Desandadores	159, 160
Caixas de ferramenta	23	Despolidor de cilindros	144, 145
Caneta magnética	127	Detetor de fugas cilindros	126
Cardan	75	Encontrador de chapeiro	158, 159
Carros e caixas vazios	20 a 23	Enroladores de ar	183
Carros e composições de ferramenta	7 a 17	Estrado de mecânico	195
Centrador embraiagens	142	Esquadro metálico	113
Chave bocas	52	Extensões	76 a 78
Chave de barra direção	143	Extratores	123 a 125
Chave de bocas perfil fino	53	Extrator de juntas	132
Chave de cachimbo	53	Faca pneumática	179
Chave de injetores	133, 134	Ferramenta ajuste eixo traseiro	143
Chave de pancada (bocas e luneta)	54, 55	Ferramenta isolada 1000Volts	115 a 117
Chave de tubos	56	Ferramenta para correias	139, 140
Chave de tubos combustível	136	Ferramenta para travões	141, 142

ARTIGO	PÁG.	ARTIGO	PÁG.
Ferramenta rodar válvulas	135	Ponteira para válvula pneus	127
Ferramentas chapeiro	156 a 160	Porta bits	104
Ferramentas especiais mecânica	122 a 152	Porta caçonetos	129
Ferramentas especiais motas	154 a 156	Preguiças	122 e 196
Ferramentas especiais pesados	161, 162	Prensas de chapeiro	196
Ferramentas especiais por marca	147 a 152	Punções	111, 112
Ferro de desmonta	144	Punho para chave caixa	77
Filtros de ar	183, 184	Raspadores/ riscadores	135
Fita métrica	113	Rebarbadora pneumática	172
Funil para óleos e refrigerante	140	Rebitadora pneumática	181, 182
Gambiarra sem fios	114	Rectificadora pneumática	171, 172
Grampo segmentos	132	Reduções	76
Grampo válvulas	132	Refratómetro	126
Grua hidráulica	195	Régua metálica	113
Jogo de bits	101, 102	Régua verificação empenos motor	129
Jogo chaves caixa com roquete	58 a 59	Reparador de roscas	140, 141, 143
Kit comando motores	130, 147 a 152	Roquete pneumático	168, 169
Kit remoção de rádios	147	Roquetes	45 a 47
Limas	112	Saca casquilhos	127
Lixadora pneumática	173 a 178	Saca injectores	133
Macaco de chapeiro	196	Sacas	123 a 125
Macaco de fossa/ transmissões	194	Sangrador travões	123, 135
Macaco de rodas/ hidropneumático	195	Seringa	126
Machos e caçonetos	28, 39, 128, 129	Serra	113
Mala de electricista	145	Serra pneumática	178, 179
Mala de ferramenta	61, 62	Suporte de motores	195
Máquina decapar pneumática	179	Suporte movimentação rodas/pneus	195
Máquina descavar pneumática	171	Suporte para chaves caixa	75
Máquina pneumática impacto	164 a 167	Tabuleiros ferramenta (caixa plástico)	28 a 33 e 39 a 40
Martelo pneumático	181	Tabuleiros ferramenta (EVA)	34 a 39
Martelos	110	Tabuleiros vazios	41 a 43
Martelos de chapeiro	158	Tesoura	91
Medidor angular de torque	128	Tesoura pneumática	180
Medidor discos travão	144	Teste atuadores	146
Medidor de passo de rosca	128	Teste compressão/ pressão	132, 133, 146
Medidor de profundidade	144	Teste de vácuo/ pressão	135
Medidor de pressão pneus	127	Teste fluido travões	146
Merchandising	188 a 191	Teste fluxo e retorno injectores	133
Micrómetro	114	Teste pressão radiadores	122
Molas de plástico	162	Teste turbo	134
Multímetros	197	Tira mossas	159
Organizador de peças	131	Tomadas de ar	184, 185
Paquímetro	113	Torno de bancada	25
Pesca magnético	127	Travessa para portas	196
Pinça amperimétrica	197	Travessa para motores	195, 196
Pinças de chapeiro	159, 160	Tubo espiral para ar	184
Pistola de pintura	176, 177	Turquês	91
Pistola vaporizadora (tornado)	126	Ventosas	157
Pistoletes ar/ água	183	Verificador altura calços travão	142
Polidora pneumática	173, 174	X-ato/ navalha	113



Com ferramentas pneumáticas não utilizar chaves de caixa, juntas universais ou outras ferramentas de uso manual.



Não utilizar martelos ou tubos para aumentar o binário em chaves de aperto, chaves dinamométricas e roquetes.



Não utilizar chaves de parafusos como alavanca, punção ou escopro. Existem séries especiais de chaves de parafusos que podem ser marteladas.

Ferramentas Manuais

- Deverá ter bastante cuidado ao utilizar qualquer ferramenta, mantendo-a afastada das crianças.
- Recomenda-se utilizar sempre máscaras, óculos, auriculares e luvas de proteção (se aplicável).
- Deverá desligar sempre a energia elétrica antes de efetuar trabalhos em qualquer tipo de máquina ou equipamento elétrico ou junto de superfícies condutoras, pois poderão ocorrer choques elétricos. Nestes casos, utilizar sempre ferramentas isoladas.
- Deverá escolher o tipo e tamanho correto da ferramenta para o trabalho a realizar. As unidades de medida servem para selecionar a ferramenta com tamanho certo.
- Deverá manter as ferramentas limpas.
- Deverá ler as instruções antes de utilizar as ferramentas.
- Não deverá modificar nenhuma ferramenta.
- Nos carro de ferramentas, nunca deverá abrir mais do que uma gaveta de cada vez (perigo de tombar).
- Nos carro de ferramentas, nunca deverá usar uma gaveta como escada (perigo de tombar).
- Não deverá puxar de costas o carro de ferramentas.

Ferramentas Pneumáticas

As ferramentas pneumáticas Jonnesway permitem que os operadores usufruam de uma utilização segura, um desempenho excelente e reduzidas vibrações. As seguintes instruções de segurança são para as condições normais de utilização. Antes de utilizar as ferramentas pneumáticas, deverá ler com atenção estes avisos para evitar perigos desnecessários.

• Utilizar Proteção Pessoal

Deverá usar sempre proteção (como por exemplo máscaras, óculos, auriculares, luvas, etc.) quando manusear ferramentas pneumáticas de modo a evitar ferimentos.

• Evitar Danos Causados por Vibrações ou Movimentos de Trabalho Repetitivos

A exposição prolongada a vibrações ou a movimentos de trabalho repetitivos poderá ser prejudicial. Se sentir formigueiro, entorpecimento, desconforto ou dor, deverá parar de utilizar a ferramenta de imediato. Os operadores deverão seguir sempre as instruções a seguir indicadas:

- Utilizar as pegadas do equipamento para garantir a sua rigidez e eficiência.
- Manter os pulsos o mais direito possível.
- Evitar movimentos muito repetitivos das mãos e pulsos.
- Manter as mãos e o corpo quentes e secos.
- Evitar a exposição contínua a vibrações por períodos muito prolongados.



• **Evitar os Perigos do Ar Comprimido**

- O ar sob pressão pode causar ferimentos. Por favor, observar as seguintes instruções de segurança para garantir um ambiente de trabalho seguro.
- Não direcionar o tubo do ar para si ou para outros. Deverá afastar o escape do ar de si próprio ou de outros.
- Antes de utilizar a ferramenta pneumática, verificar a existência de tubos e acessórios danificados ou soltos.
- Deverá desligar a ferramenta sempre que estiver a substituir acessórios, definir o aperto, efetuar reparações ou não estiver a ser utilizada.
- Deverá manter sempre a pressão do ar nos valores aconselhados, já que a utilização das ferramentas fora destes valores diminuirá o seu rendimento e a vida útil da ferramenta.
- Não ligar ferramentas pneumáticas a tomadas elétricas.
- Quando utilizar uniões universais de torção, deverão ser sempre instalados pinos/garfos de bloqueio para evitar que os tubos se desliguem acidentalmente.

• **Evitar Perigos Adicionais**

- Escorregadelas, tropeções e quedas são a causa principal de ferimentos e morte em acidentes de trabalho.
- Deverá ter cuidado com o excesso de tubos e cabos existentes na área de passagem ou na superfície de trabalho.
- Os operadores e técnicos de manutenção deverão estar fisicamente aptos para efetuar as suas tarefas e suportar o volume, peso e potência da ferramenta.
- Deverão ser utilizadas proteções nas rebarbadoras para reduzir o risco de cortes e escoriações devido às rebarbas.

Sistema Pneumático de Alimentação

- ① Filtro
- ② Drenagem
- ③ Secador de Ar
- ④ Depósito de Ar
- ⑤ Compressor de Ar
- ⑥ Filtro Regulador - Lubrificador

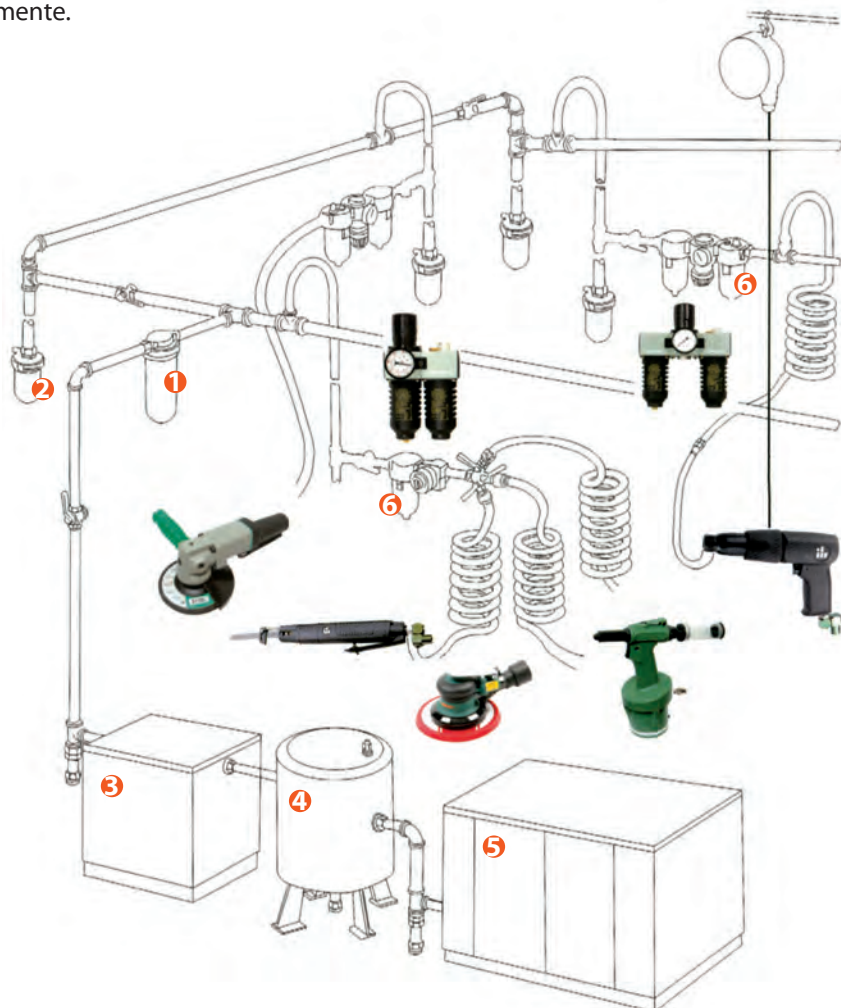

Recomendações de Manutenção

Quando ligar a ferramenta pneumática à rede de ar comprimido, deverá certificar-se que a pressão de alimentação desta deverá ser de 6.2kg/cm² (90PSI), já que se esta for demasiado elevada poderá danificar a ferramenta e se for demasiado baixa influenciará o funcionamento da mesma, reduzindo a sua vida útil.

- É recomendável a instalação dos filtros reguladores-lubrificadores adequados à ferramenta pneumática em uso. A entrada do ar deverá ter óleo lubrificante apropriado, de modo a lubrificar o motor interno da ferramenta. (Colocar um papel branco na saída do ar para verificar se existe uma sujidade gordurosa, que indique a existência de óleo suficiente).
- A entrada de ar não deverá ter água. Se tal ocorrer, recomenda-se a verificação ou instalação de um secador de ar.
- Não deverá desmontar a ferramenta, pois poderá danificá-la e afetar a segurança do utilizador.
- Mesmo que a ferramenta possua danos menores ou não efetue as funções indicadas pelo fabricante, não deverá utilizá-la até que seja inspecionada.
- Para manter o bom desempenho da ferramenta, deverá efetuar verificações regulares (semanalmente) e manutenções preventivas e lubrificações (adicionar massa lubrificante às peças rotativas e óleo lubrificante no motor).
- Sempre que utilizar as ferramentas pneumáticas deverá cumprir com as normas de segurança e instruções de funcionamento (quer aplicáveis à proteção do utilizador, quer à correta utilização da ferramenta).
- É essencial escolher as ferramentas certas e adequadas para o trabalho a realizar, já que se a ferramenta tiver uma potência muito elevada, poderá causar danos na peça em que está a trabalhar e se tiver pouca potência, poderá ficar danificada.

Condições Gerais de Garantia

A ferramenta manual e pneumática Jonnesway é fabricada com os mais elevados padrões de qualidade, mas é, para todos os efeitos, uma ferramenta de desgaste. É pois normal que a ferramenta sofra alteração de algumas características físicas durante o período de utilização, mesmo quando usada em condições normais.

Assim, a garantia da ferramenta fica dependente do conjunto das seguintes condições gerais:

- Para ferramentas manuais é oferecida uma garantia de “vida útil”, garantia esta que cobre defeitos de materiais e fabrico.
Entende-se como “vida útil” o período de tempo de vida expectável para a peça de ferramenta em causa, desde que utilizada sempre nas condições normais de utilização e para as quais foi concebida.
- A gama de ferramentas pneumáticas e ferramentas de medição estão excluídas do ponto anterior. Os produtos foram desenhados e fabricados para uso profissional. O período de garantia é de um ano (12 meses) para uso profissional e de dois anos (24 meses) para uso particular. O período de garantia inicia-se à data da aquisição. Esta data deve ser verificada mediante a fatura de aquisição.
- Qualquer produto que tenha sido utilizado ou mantido de forma incorreta, que tenha sofrido um desgaste devido a uma utilização inadequada ou que tenha sido sujeito a alterações não autorizadas, não está coberto pela garantia.
- A ausência de manutenção preventiva ou a utilização de ar comprimido com pressão e lubrificação desajustadas são motivo para a perda imediata da garantia.



JONNESWAY.



Certificate TW07/03277

The management system of

JONNESWAY ENTERPRISE CO., LTD.

6F 9, No. 51, Sec. 2, Keelung Rd., Taipei City

has been assessed and certified as meeting the requirements of

ISO 9001:2015

For the following activities

Design and trading management of JONNESWAY brand of professional hand tools, pneumatic tools, automobile repair tools, garage equipment and working machines.

This certificate is valid from 14 February 2019 until 14 February 2022 and remains valid subject to satisfactory surveillance audits. Recertification audit due a minimum of 90 days before the expiration date. Issue 5. Certified since 14 February 2007

Authorised by



SGS United Kingdom Ltd
Reference Business Park, Eldonwatts Park, Cheshire, CH83 2JX, UK
t +44 (0)191 280 6936 f +44 (0)191 280 6900 www.sgs.com
HC SGS 9001 2015 0818

Page 1 of 1







This document is issued by the Company subject to the General Conditions of Certification Services, available at www.sgs.com, and constitutes the property of SGS. It is intended for the sole use of the client. Any reproduction, distribution, copying or modification of the content is prohibited. If this document is printed and obtained by the client, it is the client's responsibility to ensure its confidentiality.



JONNESWAY®

Ferramentas Profissionais



CARROS, ARMÁRIOS
E COMPOSIÇÕES



FERRAMENTA MANUAL
PARA USO GERAL



FERRAMENTA ISOLADA 1 000V



FERRAMENTA DEDICADA
AO RAMO AUTOMÓVEL



FERRAMENTA PARA
VEÍCULOS PESADOS



FERRAMENTA ESPECIAL
PARA MOTOS



FERRAMENTA PARA
PINTURA E CHAPARIA



FERRAMENTA PNEUMÁTICA



Importador para Portugal, França, Espanha, Angola e Cabo Verde



Lusilectra
Salvador Caetano

Rua Engº Ferreira Dias, 953/993 • 4100-247 Porto • Portugal
Tel. +351 226 198 750 • Email. lusilectra@lusilectra.pt
www.lusilectra.com • www.jonneswaytools.com

Distribuidor / Revendedor

