

Nine⁹®

Main Catalog IV



MINIMUM CONSUMABLE CUTTING



Nine9 insert only takes <5% carbide raw material compared to a whole solid carbide tool and still can achieve good performance.

- Can be used nearly 20 times
- Reduces the raw material
- Reduces carbon emission

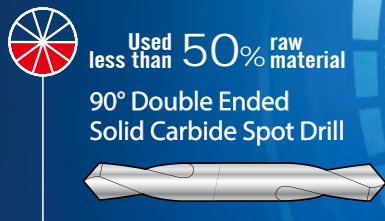

Carbon
Reduction

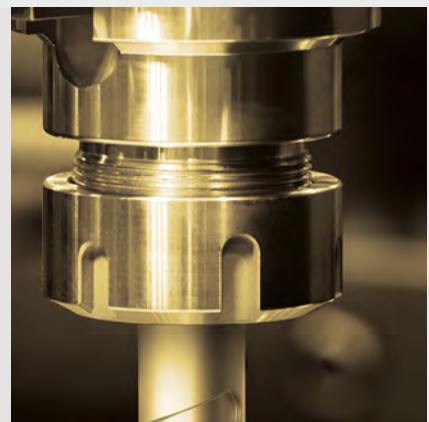

PASSION PERSEVERANCE DETERMINATION



Nine9 company began in 1994 and with the development of special tools, boring heads and accessories.

The Nine9 logo was commissioned in 1999.

It comes from the Chinese characters meaning "long life and durability" – words which aptly describe all Nine9 tools. 99 is the largest 2 digit number, indicating maximum product endurance.

Nine9 tools whilst being "special" in the industry, are standard in our product range.

NC spot drill , super power drill , boring tool , engraving tool , i-Center , NC helix drill , chamfer mill, ACE spot drill and deburring mill.

Those established Nine9 as one of market leader and innovator in the cutting tool field.

INNOVATION PATENTS

We have invested resources in the design & manufacture of indexable cutting tools. Our outstanding R&D team works in close collaboration with our clients to address unique challenges .

PRODUCT MILESTONE

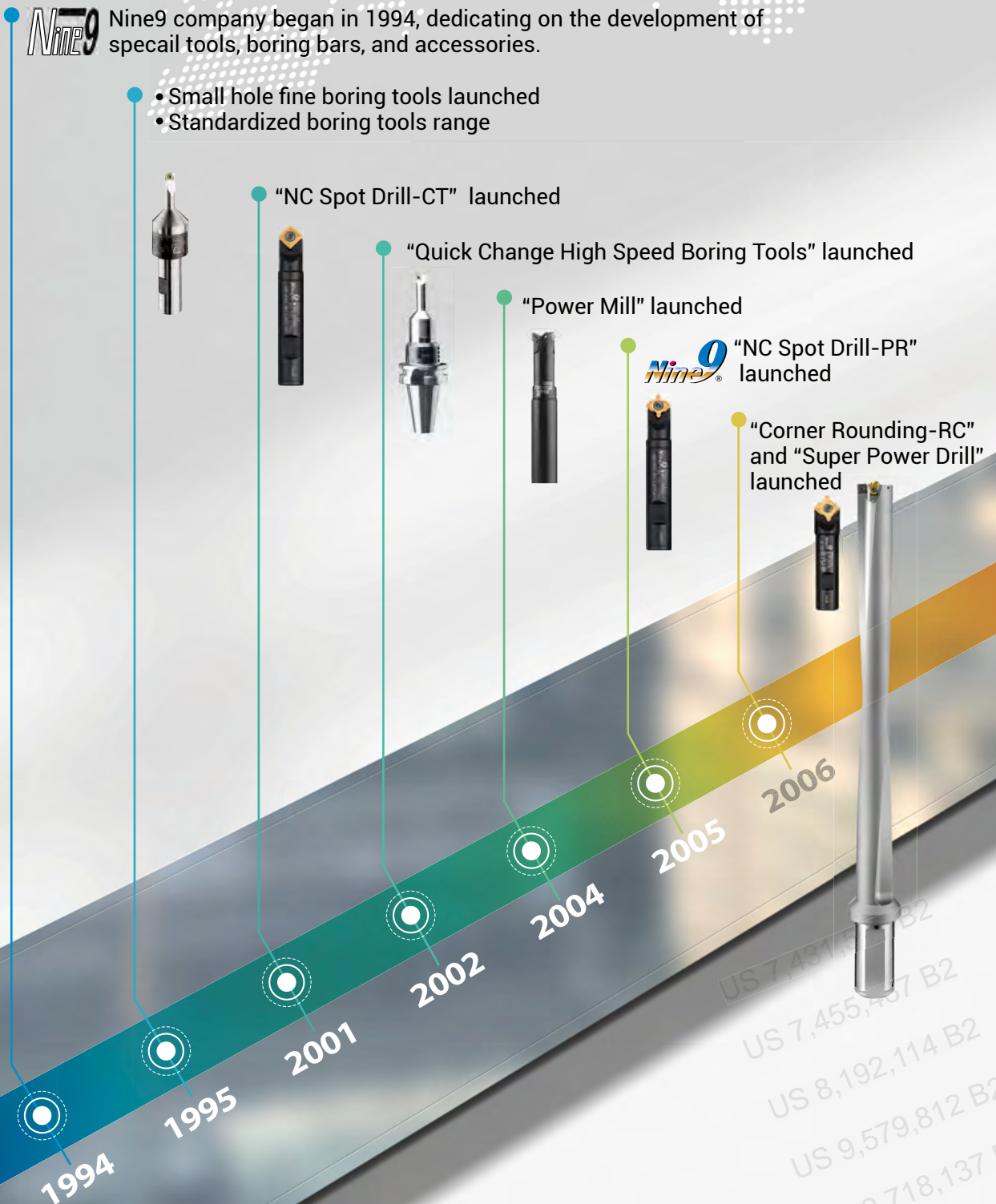

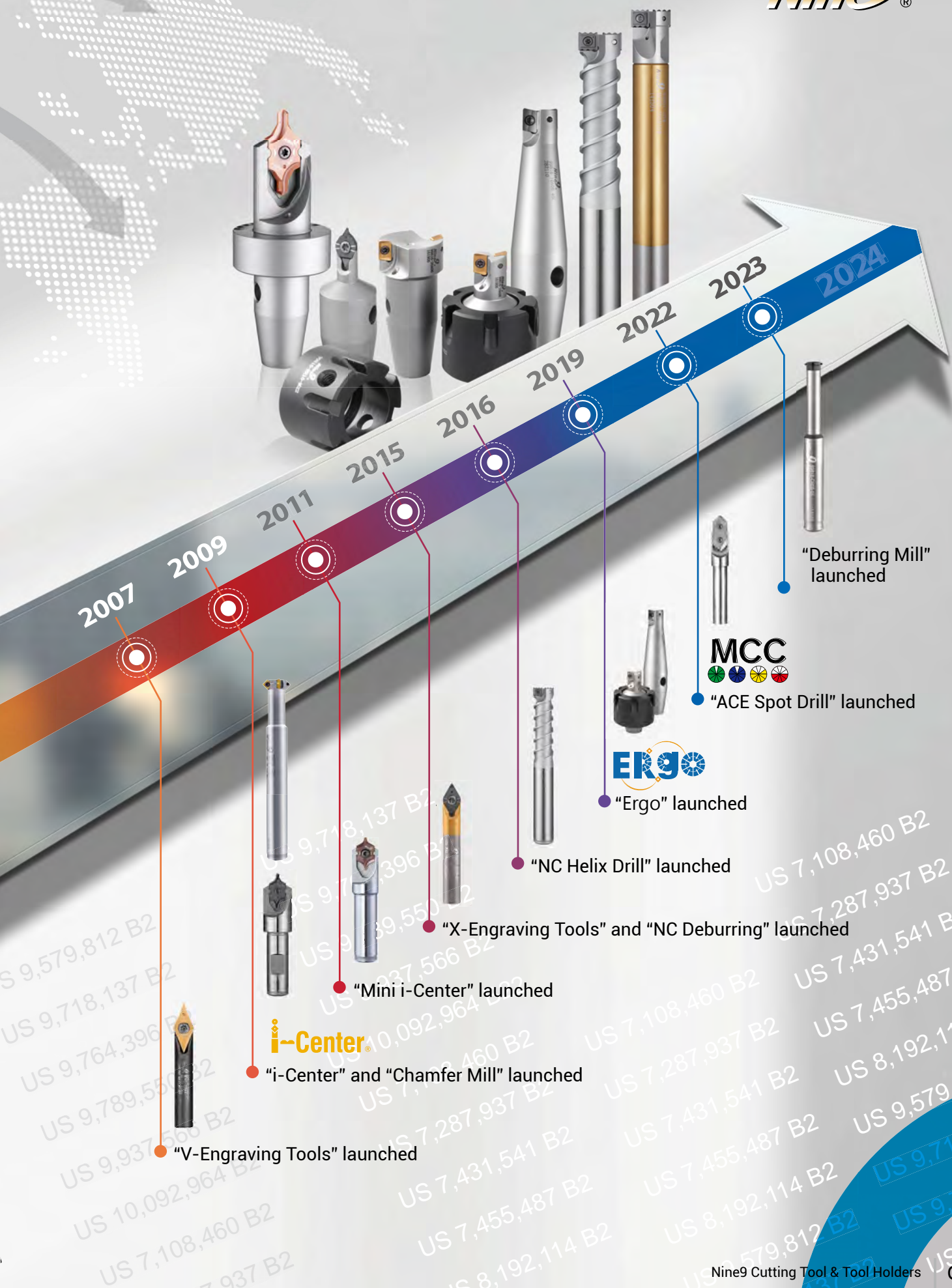

i-Center

ERGO

MCC



ACE Spot Drill | 90° / 120° / 142°



Spotting



Countersink

Accuracy! Coolant! Efficiency!

- High rigidity, high performance cutting, ultra-long tool life.
- 3 angles : 90°/ 120°/ 142°.
- 6 different sizes of insert.
- 2 flutes edged is symmetric, it reduces the lateral force while cutting in Ap.



Micro Spot Drill | 90° / 120° / 142°



Spotting

0.1 and 0.2mm bottom width

- It produces a consistent surface for micro drill successfully to enter the workpiece especially for round, angled or curved surfaces.
- To improve hole location and tool life of a deep hole drill or micro drill.
- High efficiency! Long tool life! Cost saving!



NC Spot Drill | 60° ~ 145°



Spotting



Chamfering



Facing



Engraving



Grooving

One tool will perform multiple applications

- One basic holder supports CT, RC and WSP inserts.
- A wide range of spotting angle including 60°/82°/90°/100°/142°/145°.
- Ideal for CNC lathes, CNC turning centers & machining centers.
- Increase cutting speed with coated carbide inserts. Long tool life.



Corner Rounding | RC0.5 ~ 10.0mm



Various corner radius inserts can fit on same holder

- Inserts are CNC ground for precision radius and location. Long tool life.
- Produces smooth and excellent surface finish on workpiece.
- Combination of corner rounding and 45° chamfering applications on same insert.
- Higher cutting speed and feed rate.





Indexable Center Drill « i-Center »



DIN 332 R



DIN 332 A+B



DIN 332 A



ANSI 60°

Pilot dia.
1~10mm



Long Tool Life! No need tool length resetting

- Excellent repeatability by insert type within 0.02mm in radial direction.
- Shorten set up and center drilling time.
- 0.05mm axial positional accuracy.
- Coolant can be supplied through the center of holder.



Engraving Tool | 30° / 45° / 60° / 90°



Engraving



Spotting

Different Angle! Burr-Free!

- Multi-side grinding, excellent performance.
- Higher cutting speed and DOC.
- No need to reset tool length.
- Widely used for marking on machine components, medical components, gun components, mold and die, automotive parts, gears, bearings, and luxury goods.



NC Deburring | 60° / 90°



60°



90°



Insert has 6 flutes, 6 times higher feed rate

- Ideal for fine hole deburring.
- Smallest chamfer diameter $\varnothing 0.5\text{mm}$.
- Achieve high speed and feed rate on CNC machine.
- Retain exceptional positional accuracy of the deburring depth and diameter.



Deburring Mill | 60° / 90°



Deburring



Back Deburring

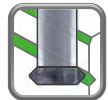

Grooving



Thread Mill

Front and back deburring, 60° also for threading

- Each insert has 6 cutting flutes.
- Provide higher feed rate, optimized performance, and reduce cycle time.
- Minimum deburring bore from $\varnothing 3.9\text{mm}$ to $\varnothing 10\text{mm}$.
- Special insert geometry and clamping system provide high precision and accurate position.





Chamfer Mill | 45°



Chamfering



Face Milling



Back Circular Chamfering



Countersink

Front and back chamfering. Ultra high speed & feed rate

- Smallest chamfer insert in the world.
- Smallest counter sink diameter $\varnothing 7\text{mm}$.
- 4 times faster and up to 10 times higher feed rate than competitors.
- Dual relief angle insert, special edge honning and optimized coated.



Ergo System | ER11 / ER16 / ER20



Integrated ER taper-shank cutter

- Optimize the rigidity.
- Easy and simple assembly.
- Quick change, saving huge machine downtime.
- Excellent repeatability, saving set-up time.
- The ergo system includes milling cutters, spot drills, engraving tools, deburring tools, chamfering tools, center drills and chamfer mill.



NC Helix Drill | $\varnothing 13\text{mm} \sim \varnothing 65\text{mm}$

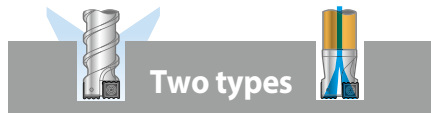

Two types

Ideal for automation production. Excellent swarf removal

- Cuts materials by Helical interpolation.
- Just 6 tools can drill $\varnothing 13 \sim \varnothing 65\text{mm}$ holes.
- Serrated cutting edge minimizes cutting chips.
- Good for drilling on soft and long cutting chip material.
- Circular ramping milling, maximum ramping angle is 20° .



Super Power Drill | 5xD ~ 10xD



Special pocket design for center pilot insert

5~10xD : $\varnothing 19 \sim \varnothing 40\text{mm}$ 12xD is also possible

- The unique design of insert pocket provides the best accuracy and rigidity of center insert.
- The center and peripheral inserts are positioned in order to divide the cutting chips into smaller spiral shape.
- Better surface finish. It can reduce your roughing operation.
- Lateral cutting forces can be absorbed by center insert due to a patented pocket design.





Super Drill | 3xD & 4xD

3xD : Ø10 ~ Ø30mm

4xD : Ø16 ~ Ø30mm

Smallest indexable drill from Ø10mm.

- Same insert for outer and inner insert.
- Better surface finish and better diameter accuracy.
- Possible to drill into angled surfaces without pre-drilling.



Power Mill | start from Ø10mm



Indexable milling cutter Ø10mm. Higher wear resistance!

- Patented Dual Relief Angle Insert.
- Precision ground insert performs efficient repeatability and excellent accuracy.
- Special geometry design helps the strength of cutting edge in shoulder milling operation.
- Two types of shank - Screw fit type and Cylindrical type.



Boring Tool | Ø5mm~Ø50mm



Easy adjustment! No backlash! G6.3 /10,000 r.p.m.

- Eccentric mechanism boring bars. • Adjusting range :±0.1mm
- Ø5mm~Ø50mm boring bars are interchangeable.
- Good for fine boring operation on milling machines, machining centers and special purpose machines.
- Replace solid carbide reamers.



0
1
2
3
4
5
6
7
8
9
10
11
12
13
14
15
16
17
18
19
20
21
22
23
24
25
26

“Awarded **PATENTS**”

No Need To Choose
Nine9 Does It All!



US 7,108,460 B2

US 7,287,937 B2

US 7,431,541 B2

US 7,455,487 B2

US 8,192,114 B2

US 9,579,812 B2

US 9,718,137 B2

US 9,764,396 B2

US 9,789,550 B2

US 9,937,566 B2

US 10,092,964 B2

RESEARCH & INNOVATION

CONTENTS

	Group	Page
1 SERIES	ACE Spot Drill	1-12
2 SERIES	Micro Spot Drill / NC Spot Drill	2-18
	Corner Rounding	2-36
	i-Center <small>i-Center</small>	2-48
3 SERIES	Engraving Tool	3-62
4 SERIES	NC Deburring	4-78
	Deburring Mill	4-80
	Chamfer Mill	4-84
5 SERIES	Ergo ER Taper-Shank Cutter 	5-90
6 SERIES	NC Helix Drill	6-108
7 SERIES	Super Power Drill / Super Drill	7-122
8 SERIES	Power Mill	8-136
9 SERIES	NineBore Boring Tool	9-142



Accuracy

Coolant

Efficiency

ACE Spot Drill >>>

Spotting Concept!

Spotting produces a shallow hole to get better hole position enabling to produce more accurate final product. Ideally, the proper spotting angle should have larger point angle than that of your drill, so the center of a drill shall be the first point to contact workpiece to avoid the drill walked or moved in starting drilling.



► Dual Clamping Screwed Design

- Ensures the vibration free during the cutting



Features >>>

► 3 Angles : 90° / 120° / 142°

90°

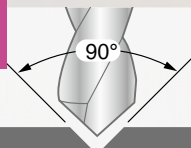

• For 90° point angle drill.

120°

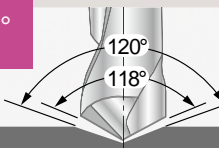

• For spotting before drilling by 118° point angle drill.

142°

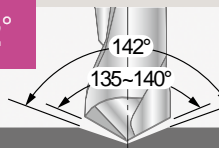

• For spotting before drilling by 135°~140° point angle high performance drill.

► Excellent Repeatability. No Need Tool Length Re-setting By Insert Type.

► High Rigidity, High Performance Cutting, Ultra-long Tool Life.

- Symmetric 2-flute edge design reducing the lateral force, it enhances ACE Spot drill rigidity enabling to run high feed rate.
- Double point angle makes the insert tip stronger to prolong service life, which results in lower production cost.



Applications



Can drill with minimum quantity lubrication (MQL).

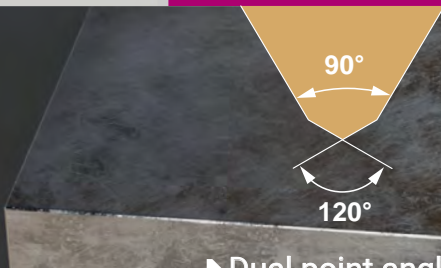

► **Dual point angle**
• The double point angles ensure strength at the centre to prevent fracturing.



Internal Coolant

• Optimized coolant design for better balancing.



2-flutes Edged

• It is symmetric.

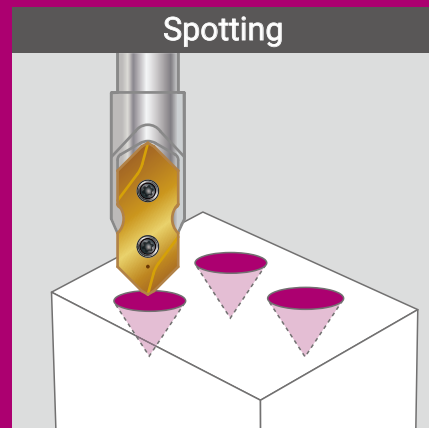

Spotting

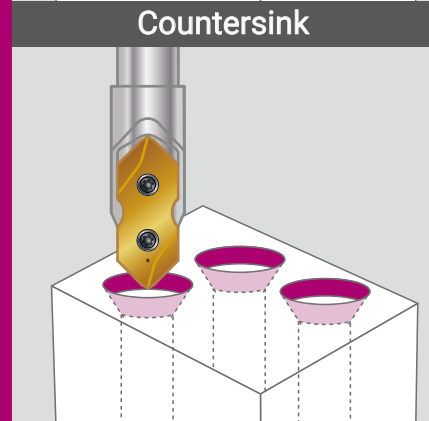

Countersink

“ **Nine9 spotting tool improves hole position, increases drill feed rate, extends tool life, enhances production efficiency, and ensures uniform hole quality.** ”



ACE Spot Drill

ACE Spot Drill spotting and countersink

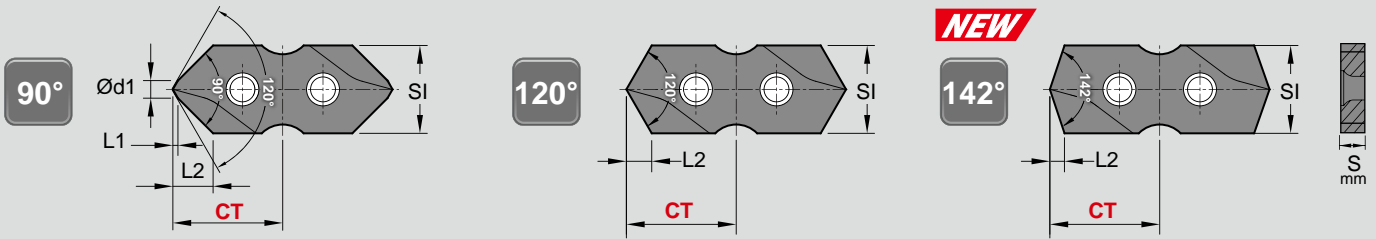

► Inserts >>

- NC2057:**
 - Universal grade for alloy steel and cast iron.
 - Each insert has 2 cutting edges.
- NC5254:**
 - For stainless steel.
 - Each insert has 2 cutting edges.
- XP9000:**
 - High positive geometry and sharp edge produces excellent surface finish.
 - For non-ferrous material such as aluminum, titanium, brass, copper and long cutting chip metal.
 - Each insert has 2 cutting edges.

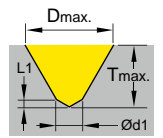

SI	Angle ±0.5	Code	Parts No.	Coating	Grade	Dimensions			Dmax.	Tmax.	S	CT ±0.025
						Ød1	L1	L2				
06	90°	06A031		NC2057	AlTiN+TiSiN	P35	1.2	0.35	2.75	5.5	2.5	7.5
		06A033	S9MT06T1-090	NC5254	Helica							
		06A032		XP9000	Uncoated							
	120°	06A041		NC2057	AlTiN+TiSiN		-	-	1.73	5.5	1.6	1.8
		06A043	S9MT06T1-120	NC5254	Helica							
		06A042		XP9000	Uncoated							
	142°	06A051		NC2057	AlTiN+TiSiN		-	-	1.03	5.5	0.95	7.0
		06A053	S9MT06T1-142	NC5254	Helica							
		06A052		XP9000	Uncoated							
08	90°	06A131		NC2057	AlTiN+TiSiN	P35	1.6	0.46	3.6	7.5	3.4	10
		06A135	S9MT0802-090	NC5254	Helica							
		06A132		XP9000	Uncoated							
	120°	06A141		NC2057	AlTiN+TiSiN		-	-	2.3	7.5	2.2	2.4
		06A143	S9MT0802-120	NC5254	Helica							
		06A142		XP9000	Uncoated							
	142°	06A151		NC2057	AlTiN+TiSiN		-	-	1.38	7.5	1.29	9
		06A153	S9MT0802-142	NC5254	Helica							
		06A152		XP9000	Uncoated							
10	90°	06A231		NC2057	AlTiN+TiSiN	P35	2	0.58	4.6	9.5	4.4	12.50
		06A233	S9MT1003-090	NC5254	Helica							
		06A232		XP9000	Uncoated							
	120°	06A241		NC2057	AlTiN+TiSiN		-	-	2.9	9.5	2.7	3.0
		06A243	S9MT1003-120	NC5254	Helica							
		06A242		XP9000	Uncoated							
	142°	06A251		NC2057	AlTiN+TiSiN		-	-	1.72	9.5	1.64	11.50
		06A253	S9MT1003-142	NC5254	Helica							
		06A252		XP9000	Uncoated							
12	90°	06A331		NC2057	AlTiN+TiSiN	P35	2.4	0.69	5.5	11.5	5.3	15
		06A333	S9MT1203-090	NC5254	Helica							
		06A332		XP9000	Uncoated							
	120°	06A341		NC2057	AlTiN+TiSiN		-	-	3.5	11.5	3.3	3.0
		06A343	S9MT1203-120	NC5254	Helica							
		06A342		XP9000	Uncoated							
	142°	06A351		NC2057	AlTiN+TiSiN		-	-	2.07	11.5	1.98	13.5
		06A353	S9MT1203-142	NC5254	Helica							
		06A352		XP9000	Uncoated							

* 60° spotting inserts are available on request.

The quantity of insert per box.:

SI 06	SI 08	SI 10	SI 12	SI 16	SI 20
5 pcs	5 pcs	5 pcs	5 pcs	2 pcs	1 pcs

ACE Spot Drill spotting and countersink

► Inserts >>

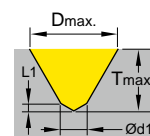

SI	Angle ±0.5	Code	Parts No.	Coating	Grade	Dimensions			Dmax.	Tmax.	S	CT ±0.025
						Ød1	L1	L2				
16	90°	06A431		NC2057	AITiN+TiSiN	3.2	0.92	7.3	15.5	7.0	3.18	20
		06A433	S9MT1603-090	NC5254	Helica							
		06A432		XP9000	Uncoated							
	120°	06A441		NC2057	AITiN+TiSiN	-	-	4.6	15.5	4.4		
		06A443	S9MT1603-120	NC5254	Helica							
		06A442		XP9000	Uncoated							
142°	06A451		NC2057	AITiN+TiSiN	-	-	2.76	15.5	2.67			
	06A453	S9MT1603-142	NC5254	Helica								
	06A452		XP9000	Uncoated								
20	90°	06A531		NC2057	AITiN+TiSiN	4.0	1.16	9.2	19.5	8.9	4.76	25
		06A533	S9MT2004-090	NC5254	Helica							
		06A532		XP9000	Uncoated							
	120°	06A541		NC2057	AITiN+TiSiN	-	-	5.8	19.5	5.6		
		06A543	S9MT2004-120	NC5254	Helica							
		06A542		XP9000	Uncoated							
	142°	06A551		NC2057	AITiN+TiSiN	-	-	3.44	19.5	3.36		
		06A553	S9MT2004-142	NC5254	Helica							
		06A552		XP9000	Uncoated							

* 60° spotting inserts are available on request.

The quantity of insert per box.:

SI 06	SI 08	SI 10	SI 12	SI 16	SI 20
5 pcs	5 pcs	5 pcs	5 pcs	2 pcs	1 pcs

► Cylindrical Shank >>

- Made of hardened high alloy steel, 53 HRC.
- Internal coolant.

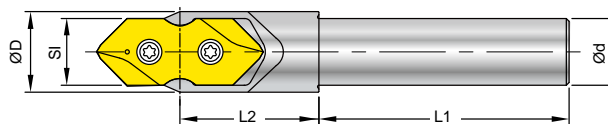
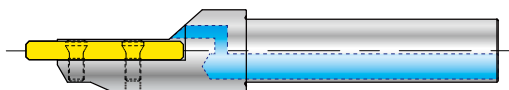

SI	Code	Parts No.	Ød	L1	L2	ØD	Screw	Key
06	6A0001	00-99688-SI06-06	6	27	14	8	*NS-18037 / 0.6Nm	NK-T6
08	6A0101	00-99688-SI08-08	8	36	19	10.5	*NS-20045 / 0.6Nm	NK-T6
10	6A0201	00-99688-SI10-10	10	40	22.5	13	*NS-25060 / 0.9Nm	NK-T7
12	6A0301	00-99688-SI12-12	12	45	25	15.5	NS-30072 / 2.0Nm	NK-T9
16	6A0401	00-99688-SI16-16	16	48	32	21	NS-35080 / 2.5Nm	NK-T15
20	6A0501	00-99688-SI20-20	20	50	35	26	NS-50125 / 5.5Nm	NK-T20

*Torque screwdriver is recommended.

► Screw Fit Cutter >> **NEW**

- Made of hardened high alloy steel, 53 HRC.
- Internal coolant.

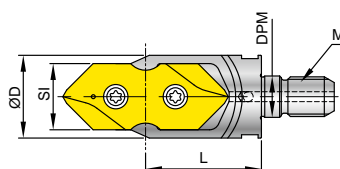

SI	Code	Parts No.	ØD	L	M	DPM	Screw	Key
06	6A2001	00-99688-SI06-M04	8	14.5	M4xP0.7	4.5	*NS-18037 / 0.6Nm	NK-T6
08	6A2101	00-99688-SI08-M05	10	19	M5xP0.8	5.5	*NS-20045 / 0.6Nm	NK-T6
10	6A2201	00-99688-SI10-M06	12	22	M6xP1.0	6.5	*NS-25060 / 0.9Nm	NK-T7
12	6A2301	00-99688-SI12-M08	16	25	M8xP1.25	8.5	NS-30072 / 2.0Nm	NK-T9
16	6A2401	00-99688-SI16-M10	20	31	M10xP1.5	10.5	NS-35080 / 2.5Nm	NK-T15
20	6A2501	00-99688-SI20-M12	25	35	M12xP1.75	12.5	NS-50125 / 5.5Nm	NK-T20

• Refer to Page 9-156 for extension bars.

*Torque screwdriver is recommended.



Technical Guide

► From spot diameter "d" to get spotting depth "t".

90°

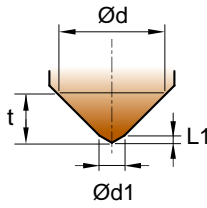

$$t = (\text{Ø}d - \text{Ø}d1) \times 0.5 + L1$$

120°

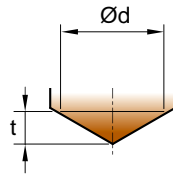

$$t = 0.289 \times \text{Ø}d$$

142°

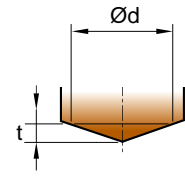

$$t = 0.172 \times \text{Ø}d$$

1

ACE Spot Drill

► STEP files



or Search on internet.



Metric	
$S = \frac{Vc \times 1000}{\pi \times d}$	d = diameter -mm S = Spindle Speed -r.p.m. Vc = Cutting Speed -m/min.
$F = S \times f$	f = mm/rev. F = mm/min.

Inch	
$S = \frac{(3.82 \times \text{SFM})}{d}$	d = diameter-inch S = Spindle Speed-r.p.m. SFM = Surface Speed-ft./min.
$\text{SFM} = Vc \times 3.28$	f = IPR = inch/rev. F = inch/min.
$F = \text{r.p.m.} \times \text{IPR}$	

Cutting Data

S106- S9MT06T1

Workpiece Material	Vc (m/min)	f (mm/rev.)			Grade of insert
		90°	120°	142°	
P Carbon steel C<0.3% Carbon steel C>0.3% Low alloy steel C<0.3% High alloy steel C>0.3%	120 ~ 250				NC2057
	100 ~ 220	0.02 ~ 0.08	0.02 ~ 0.10	0.02 ~ 0.10	
	100 ~ 200	0.02 ~ 0.07	0.02 ~ 0.08	0.02 ~ 0.08	
	80 ~ 180	0.02 ~ 0.06	0.02 ~ 0.07	0.02 ~ 0.07	
M Stainless Steel	30 ~ 80	0.01 ~ 0.03	0.01 ~ 0.03	0.01 ~ 0.03	NC5254
K Casting Iron	80 ~ 180	0.02 ~ 0.08	0.02 ~ 0.10	0.02 ~ 0.10	NC2057
N Al, and non-ferrous metal	150 ~ 300	0.03 ~ 0.10	0.03 ~ 0.12	0.03 ~ 0.12	XP9000

S108- S9MT0802

Workpiece Material	Vc (m/min)	f (mm/rev.)			Grade of insert
		90°	120°	142°	
P Carbon steel C<0.3% Carbon steel C>0.3% Low alloy steel C<0.3% High alloy steel C>0.3%	120 ~ 250				NC2057
	100 ~ 220	0.03 ~ 0.10	0.03 ~ 0.12	0.03 ~ 0.12	
	100 ~ 200	0.03 ~ 0.08	0.03 ~ 0.10	0.03 ~ 0.10	
	80 ~ 180	0.03 ~ 0.07	0.03 ~ 0.08	0.03 ~ 0.08	
M Stainless Steel	30 ~ 80	0.01 ~ 0.04	0.01 ~ 0.04	0.01 ~ 0.04	NC5254
K Casting Iron	80 ~ 180	0.03 ~ 0.10	0.03 ~ 0.12	0.03 ~ 0.12	NC2057
N Al, and non-ferrous metal	150 ~ 300	0.03 ~ 0.12	0.03 ~ 0.15	0.03 ~ 0.15	XP9000

Cutting Data

SI10 - S9MT1003

Workpiece Material	Vc (m/min)	f (mm/rev.)			Grade of insert
		90°	120°	142°	
P Carbon steel C<0.3% Carbon steel C>0.3% Low alloy steel C<0.3% High alloy steel C>0.3%	120 ~ 250	0.04 ~ 0.15	0.05 ~ 0.20	0.05 ~ 0.20	NC2057
	100 ~ 220				
	100 ~ 200				
	80 ~ 180				
M Stainless Steel	30 ~ 80	0.01 ~ 0.04	0.01 ~ 0.04	0.01 ~ 0.04	NC5254
K Casting Iron	80 ~ 180	0.03 ~ 0.12	0.05 ~ 0.15	0.05 ~ 0.15	NC2057
N Al, and non-ferrous metal	150 ~ 300	0.04 ~ 0.20	0.05 ~ 0.25	0.05 ~ 0.25	XP9000

SI12 - S9MT1203

Workpiece Material	Vc (m/min)	f (mm/rev.)			Grade of insert
		90°	120°	142°	
P Carbon steel C<0.3% Carbon steel C>0.3% Low alloy steel C<0.3% High alloy steel C>0.3%	120 ~ 250	0.05 ~ 0.20	0.06 ~ 0.25	0.06 ~ 0.25	NC2057
	100 ~ 220				
	100 ~ 200				
	80 ~ 180				
M Stainless Steel	30 ~ 80	0.01 ~ 0.04	0.01 ~ 0.04	0.01 ~ 0.04	NC5254
K Casting Iron	80 ~ 180	0.04 ~ 0.15	0.05 ~ 0.20	0.05 ~ 0.20	NC2057
N Al, and non-ferrous metal	150 ~ 300	0.05 ~ 0.22	0.06 ~ 0.25	0.06 ~ 0.25	XP9000

SI16 - S9MT1603

Workpiece Material	Vc (m/min)	f (mm/rev.)			Grade of insert
		90°	120°	142°	
P Carbon steel C<0.3% Carbon steel C>0.3% Low alloy steel C<0.3% High alloy steel C>0.3%	120 ~ 250	0.05 ~ 0.20	0.06 ~ 0.25	0.06 ~ 0.25	NC2057
	100 ~ 220				
	100 ~ 200				
	80 ~ 180				
M Stainless Steel	30 ~ 80	0.01 ~ 0.04	0.01 ~ 0.04	0.01 ~ 0.04	NC5254
K Casting Iron	80 ~ 180	0.04 ~ 0.15	0.05 ~ 0.20	0.05 ~ 0.20	NC2057
N Al, and non-ferrous metal	150 ~ 300	0.05 ~ 0.25	0.06 ~ 0.25	0.06 ~ 0.25	XP9000

SI20 - S9MT2004

Workpiece Material	Vc (m/min)	f (mm/rev.)			Grade of insert
		90°	120°	142°	
P Carbon steel C<0.3% Carbon steel C>0.3% Low alloy steel C<0.3% High alloy steel C>0.3%	120 ~ 250	0.05 ~ 0.25	0.06 ~ 0.30	0.06 ~ 0.30	NC2057
	100 ~ 220				
	100 ~ 200				
	80 ~ 180				
M Stainless Steel	30 ~ 80	0.01 ~ 0.04	0.01 ~ 0.04	0.01 ~ 0.04	NC5254
K Casting Iron	80 ~ 180	0.04 ~ 0.20	0.05 ~ 0.25	0.05 ~ 0.25	NC2057
N Al, and non-ferrous metal	150 ~ 300	0.05 ~ 0.30	0.06 ~ 0.30	0.06 ~ 0.30	XP9000

1

ACE Spot Drill



Micro Spot Drill >>>

90° / 120° / 142°

0.1 & 0.2mm

It produces a consistent surface for micro drill successfully to enter the workpiece.



► One Holder Supports The Entire X060 Series Insert.

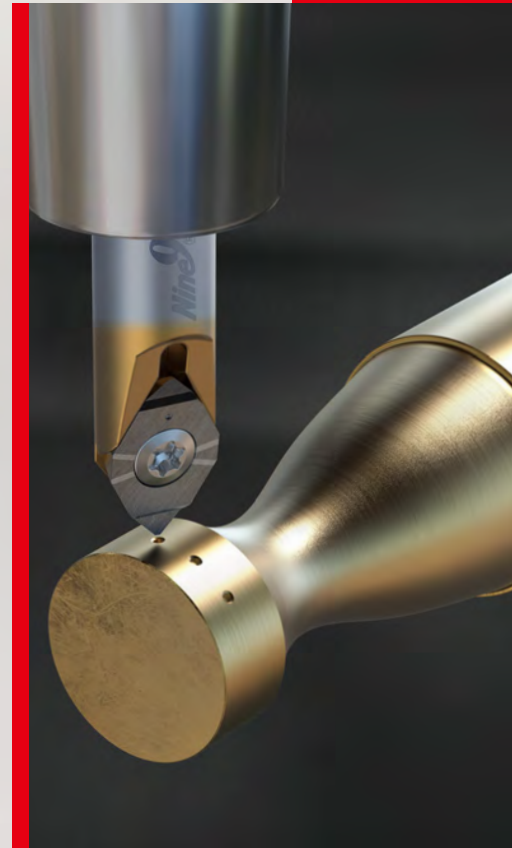

Features >

► Each Insert Has 2 Cutting Edges.

- Micro spot drill geometries are designed to optimize rigidity and accuracy with a point angle to guide micro drill towards the hole's center line.
- Carbide insert can stand very long tool life.
- It produces a consistent surface for micro drill to enter the workpiece especially for round, angled or curved surfaces.

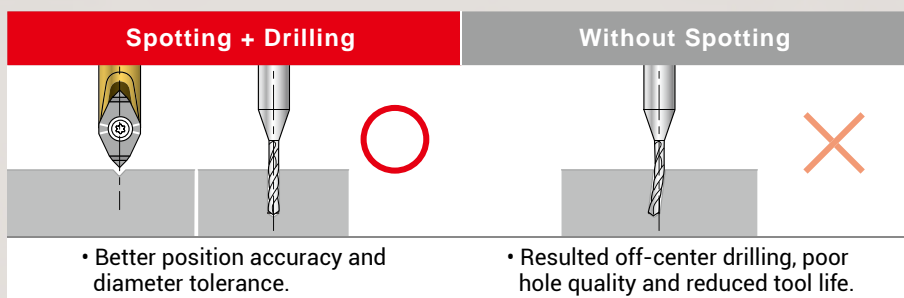

0.1 and 0.2mm Micro Spot Drill 90°, 120° & 142°

90°
120°
142°

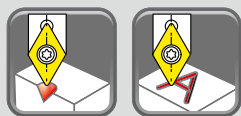

► Inserts >>

- NC2032:** • For all kinds of steel from < 40 HRC, carbon steel, alloy steel, and cast iron.
- NC2035:** • ALDURA coating, reduces heat and tool wear.
• For steel with heat treatment up to 56 HRC.
- XP9001:** • For non-ferrous metal, aluminum, brass, copper, plastic, acrylic.

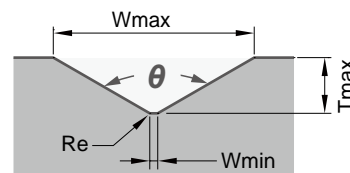

Angle	Code	Parts No.	Coating	Grade	S	Dimensions			Wmin.	Wmax.	Tmax.
						L	Re	Re			
90°	01X0082	X060A90W010R	NC2032	TiAlN	6	2.05	0.02	0.1	1.1	0.5	
	01X0221		NC2035	ALDURA							
	01X0220		XP9001	Uncoated							
90°	01X0207	*X060A90W020R	NC2032	TiAlN	6	2.05	0.04	0.2	2.2	1.0	
	01X0208		NC2035	ALDURA							
	01X0209		XP9001	Uncoated							
120°	01X0222	X060A120W010R	NC2032	TiAlN	6	2.05	0.02	0.1	2.53	0.7	
142°	01X0223	X060A142W010R	NC2032	TiAlN	6	2.05	0.02	0.1	2.42	0.4	

* X060A90W020R is also good for engraving.

► Holder >>

- One holder supports the entire X060 series of carbide inserts.

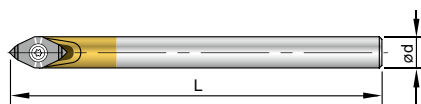

Code	Parts No.	Shank	Ød	L	Screw	Key
69X001	00-99619-X060-06	Steel	6	40	*NS-22044 0.9Nm	NK-T7
69X002	00-99619-X060-06L	Carbide	6	60		
69X003	00-99619-X060-06LS	Steel	6	100		
69X004	00-99619-X060-06XL	Carbide	6	100		
69X005	00-99619-X060-08	Steel	8	60		

*Torque screwdriver is recommended.

► Cutting Data >>

Workpiece Material	S (r.p.m)	f (mm/rev.)			Grade of Insert
		X060A90W010R	X060A90W020R	X060A120W010R X060A142W010R	
P Carbon steel C<0.3%	8000 ~ 40000	0.002 ~ 0.012	0.002 ~ 0.015	0.001 ~ 0.015	NC2032
P Carbon steel C>0.3%		0.002 ~ 0.010	0.002 ~ 0.012	0.001 ~ 0.012	NC2032
P Alloy steel		0.002 ~ 0.010	0.002 ~ 0.010	0.001 ~ 0.010	NC2032, NC2035
M Stainless steel		0.002 ~ 0.008	0.002 ~ 0.010	0.001 ~ 0.010	NC2032
K Casting iron		0.002 ~ 0.010	0.002 ~ 0.010	0.001 ~ 0.010	NC2032
N Non-ferrous metal (Al, Cu)		0.002 ~ 0.015	0.002 ~ 0.020	-	XP9001
H Hardened steel up to 56 HRC		0.002 ~ 0.006	0.002 ~ 0.006	-	NC2035

2

Micro Spot Drill



NC Spot Drill >>>

No Need To Choose, Nine9 Does It All!

NC Spot Drill with indexable carbide insert.
High efficiency! Long tool life! Cost saving!



- ▶ Various Inserts Can Fit On The Same Tool Holder.
- ▶ One Tool For Various Applications.



Features >>>

- ▶ Spotting Produces Better Hole Position And Geometrically Uniform Holes.
- ▶ Available Shank Diameter- $\varnothing 5, \varnothing 6, \varnothing 8, \varnothing 10, \varnothing 12, \varnothing 16, \varnothing 20, \varnothing 25\text{mm}, \varnothing 3/8", \varnothing 1/2", \varnothing 5/8", \varnothing 1/4", \varnothing 3/4", \varnothing 1", \text{M5, M6 And M8}$.
- ▶ $60^\circ / 82^\circ / 90^\circ / 100^\circ / 142^\circ / 145^\circ$ Angle For Different Applications.
 - Suitable for spotting, chamfering, facing, grooving and engraving.
 - Each insert has 2 or 4 cutting edges.
 - Increase cutting speed with coated carbide inserts.



Applications

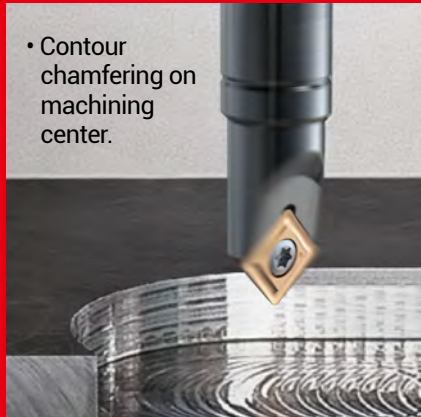

• Contour chamfering on machining center.



▼ CNC Lathes

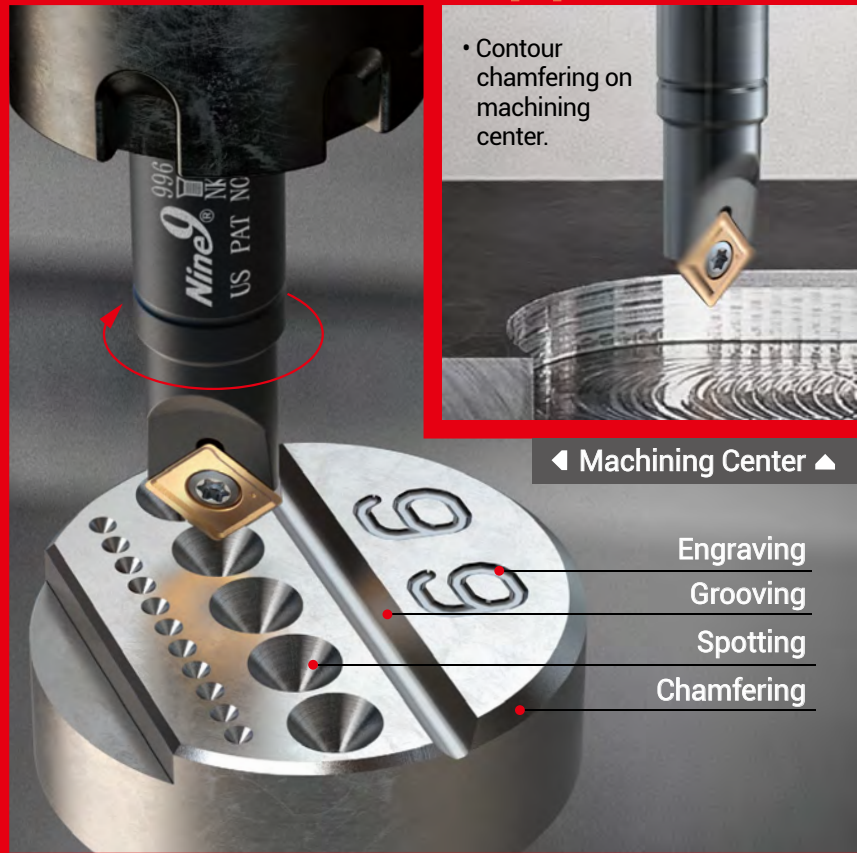

◀ Machining Center ▶

- Engraving
- Grooving
- Spotting
- Chamfering

“ One tool will perform multiple applications. Suitable for spotting, chamfering, facing, grooving and engraving. ”

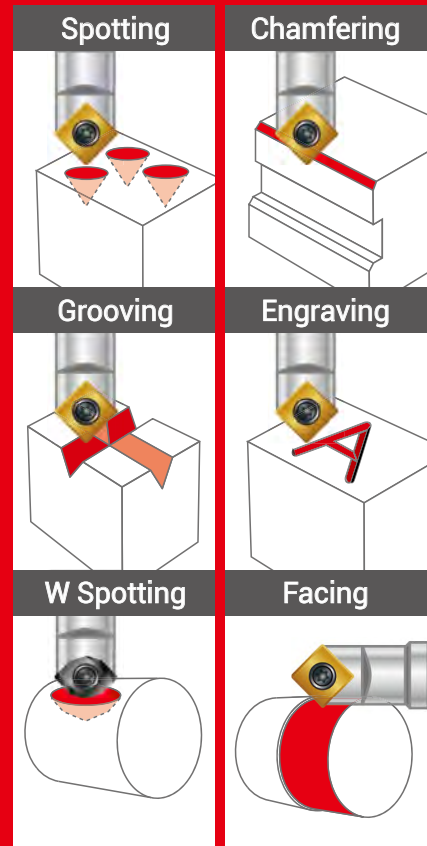

60° N9MT11T3P60



► Inserts >>

- Fully ground spotting insert, for 60 degree spotting and engraving.

- NC40:**
- Universal grade for all unhardened steel and cast iron.
 - Each insert has 2 cutting edges.

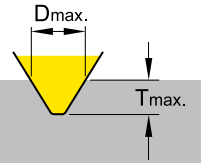

Code	Parts No.	Coating	Grade	Dimensions	Dmax.	Tmax.
014204	N9MT11T3P60-NC40	TiN	P35		6.2	4

► Holder >>

- A single cutting edge design creates higher precision and position when spotting.
- Applications: For spotting, engraving, small grooving on milling machines, machining centers.

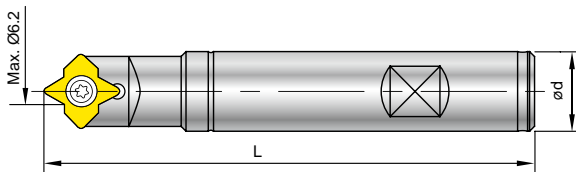

Code	Parts No.	Ød	L	Screw	Key
604002	00-99616-14-12	12	100	NS-35080 2.5 Nm	NK-T15
604004	00-99616-14	16	100		

2

NC Spot Drill

V9MT0802 / V9MT12T3

60°

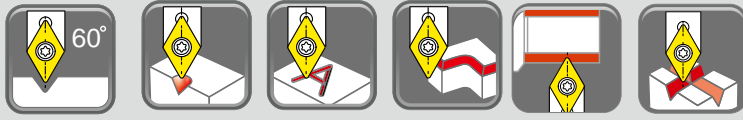

► Inserts >>

- 60 degree indexable spotting insert, Dmax 13mm.
- Special geometry with supporting edges for using in high speed machining.
- Excellent tool for grooving. Saving machining time!

NC5071:

- For high alloy steel and cast iron.
- Each insert has 2 cutting edges.

NC2071:

- For carbon steel, low alloy steel, stainless steel, non-ferrous and titanium.
- Each insert has 2 cutting edges.

NC9076:

- For non-ferrous material such as aluminum, al-alloy, titanium, brass, copper and long cutting chip metal.
- Produces excellent surface finish on non-ferrous metal.
- Each insert has 2 cutting edges.

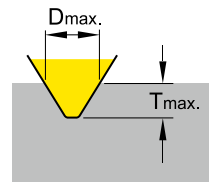

Code	Parts No.	Coating	Grade	Diagram	Dimensions			Dmax.	Tmax.	
					L	S	Re			
019202	V9MT0802CT	NC5071	TiAlN & TiN		8	2.38	0.4	9	7.3	
019201		NC2071	TiN							K20F
019203		NC9076	DLC							
015204	V9MT12T3CT	NC5071	TiAlN & TiN		12.7	3.97	0.8	13	10.3	
015201		NC2071	TiN							K20F
015202		NC9076	DLC							

► Holder >>

- A single cutting edge creates higher precision and position when spotting.
- Applications:
 - Spotting, engraving, grooving and chamfering on milling machines, machining centers.
 - Spotting, facing on CNC Lathes.

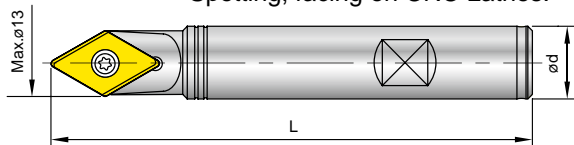

Code	Parts No.	Ød	L	Insert Type	Screw	Key
609001	00-99616-09V (Cylindrical shank)	8	60	V9MT08	*NS-25045 0.9 Nm	NK-T7
605001	00-99616-13V	16	100	V9MT12	NS-35080 2.5 Nm	NK-T15
615001	00-99616-13V-5/8	5/8"	100			

*Torque screwdriver is recommended.

2

NC Spot Drill

82° V0820802 / V08212T3

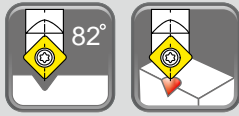

► Inserts >>

- 82 degree indexable spotting insert, Dmax. 14mm (0.551").
- Match the geometry of American standard flat head screw hole.
- Special geometry with supporting edges for high speed machining.

NC5071: • For high alloy steel and cast iron.
• Each insert has 2 cutting edges.

NC2071: • For carbon steel, low alloy steel, stainless steel, non-ferrous and titanium.
• Each insert has 2 cutting edges.

NC9076: • For non-ferrous material such as aluminum, al-alloy, titanium, brass, copper and long cutting chip metal.
• Produces excellent surface finish on non-ferrous metal.
• Each insert has 2 cutting edges.

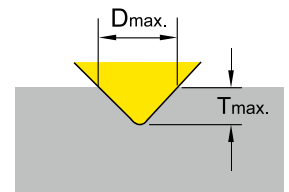

Code	Parts No.	Coating	Grade	Image	Dimensions			Dmax.	Tmax.
					L	S	Re		
0108203	NC5071	TiAlN & TiN	K20F		8	2.38	0.4	9 (0.354")	4.8 (0.189")
0108201	V0820802	TiN							
0108202	NC9076	DLC							
0108213	NC5071	TiAlN & TiN	K20F		12.7	3.97	0.8	14 (0.551")	7.5 (0.295")
0108211	V08212T3	TiN							
0108212	NC9076	DLC							

► Holder >>

- Special cutting edge design gives higher precision and position when spotting.
- Applications : • Spotting, engraving, grooving and chamfering on milling machines, machining centers.
• Spotting, facing on CNC Lathes.

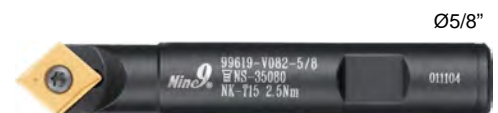
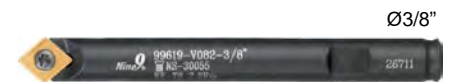
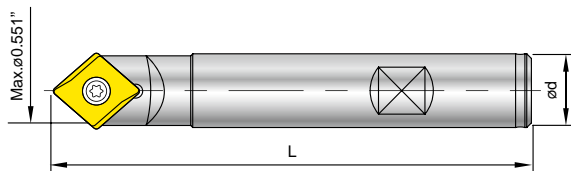

Code	Parts No.	Ød	L	Insert Type	Screw	Key
693001	00-99619-V082-3/8	3/8"	90	V0820802	NS-30055 2.0 Nm	NK-T8
693002	00-99619-V082-5/8	5/8"	100	V08212T3	NS-35080 2.5 Nm	NK-T15

2

NC Spot Drill

N9MT05T1 / N9MT0602

90°

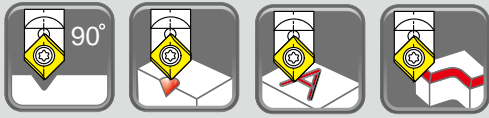

► Inserts >>

- Mini spotting drill with indexable insert, low cutting power required.
- Especially good for Swiss type automatic lathes and CNC lathes.

NC5071: • For high alloy steel and cast iron.

- Each insert has 2 cutting edges.

NC2071: • For carbon steel, low alloy steel, stainless steel, non-ferrous and titanium.

- Geometry with supporting edges to stabilize the cutting condition on low power machine.
- Each insert has 2 cutting edges.

NC9076: • For non-ferrous material such as aluminum, titanium, brass, copper and stainless steel.

- Produces excellent surface finish on non-ferrous metal.
- Each insert has 2 cutting edges.

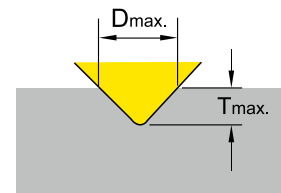

Code	Parts No.	Coating	Grade	Re	Dimensions			Dmax.	Tmax.	
					L	S	Re			
011209	NC5071	TiAlN & TiN	K20F		5	1.8	0.4	6	2.8	
011201	N9MT05T1CT	NC2071			TiN	6.35	2.38	0.4	8	3.8
011202	NC9076	DLC								
012204	NC5071	TiAlN & TiN	K20F		6.35	2.38	0.4	8	3.8	
012201	N9MT0602CT	NC2071			TiN	6.35	2.38	0.4	8	3.8
012202	NC9076	DLC								

► Holder >>

- Smallest indexable spotting drill holder.
- Single cutting edge design gives higher precision when spotting.
- Applications : • Spotting, engraving, and chamfering on milling machines, machining centers.
- Spotting, facing on CNC Lathes.

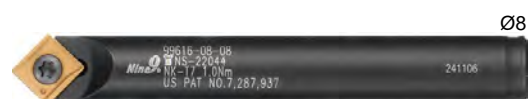
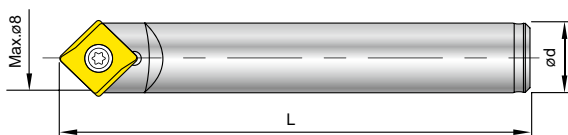

Code	Parts No.	Ød	L	Insert Type	Screw	Key
601001	00-99616-06-6	6	35	N9MT05	*NS-20036 0.6 Nm	NK-T6
601002	00-99616-06-5	5	35			
601003	00-99616-06-6L	6	60			
602001	00-99616-08-8	8	60	N9MT06	*NS-22044 0.9 Nm	NK-T7

Note:601003 is carbide shank holder.

*Torque screwdriver is recommended.

2

NC Spot Drill

90° N9MT0802



► Inserts >>

- NC40:**
 - General purpose, universal grade for all unhardened steel.
 - Each insert has 4 cutting edges.
- NC10:**
 - High positive angle and fully ground cutting edge and relief angle.
 - Universal grade for non-ferrous metal, cast iron and stainless steel.
 - Each insert has 4 cutting edges.
- H-NC5071:**
 - For carbon steel C>0.3%, high alloy steel C>0.3% and cast iron.
 - Each insert has 2 cutting edges.
- H-NC40:**
 - For carbon steel C<0.3%, low alloy steel C<0.3%, stainless steel, non-ferrous and titanium.
 - Each insert has 2 cutting edges.
- H-NC9076:**
 - High positive geometry and sharp edge.
 - For non-ferrous material such as aluminum, titanium, brass, copper and long cutting chip metal.
 - Produces excellent surface finish on non-ferrous metal.
 - Each insert has 2 cutting edges.

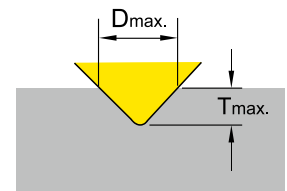

Code	Parts No.	Coating	Grade	Re	Dimensions			Dmax.	Tmax.
					L	S	Re		
013401	N9MT080208CT	NC40	TiN		8.31	2.38	10	4.5	0.8
013402	N9MT080204CT	NC40	TiN						0.4
013403		NC10	TiAlN						0.4
013206		H-NC5071	TiAlN & TiN						0.8
013201	N9MT0802CT2T	H-NC40	TiN						0.8
013202		H-NC9076	DLC						

* H type is with supporting edge.

► Holder >>

- Single cutting edge design gives higher precision when spotting.
- Applications :
 - Spotting, engraving, grooving and chamfering on milling machines, machining centers.
 - Spotting, facing, turning on CNC Lathes.

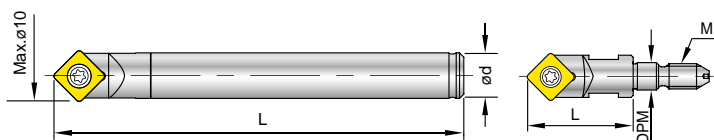

Code	Parts No.	Ød	L	M	DPM	Screw	Key
603001	00-99616-10	10	90	-	-		
603003	00-99616-10-SL10 (Weldon shank)	10	90	-	-		
613001	00-99616-3/8	3/8"	90	-	-	NS-30055 2.0 Nm	NK-T8
623001	00-99616-10-M5	-	25	M5xP0.8	5.5		
623002	00-99616-10-M6	-	25	M6xP1.0	6.5		

• Refer to Page 9-156 for extension bars.

N9MT0802

90°



► Single Set >>

Code	Parts No.	Ød	Total Length	Insert fitted	Dmax.	Tmax.
603101-3401	00-99616-10-02S	10	90	N9MT080208CT-NC40	10	4.5
603101-3403	00-99616-10-02SAL	10	90	N9MT080204CT-NC10	10	4.5

► Starter Package >>

- Selected package for starter who wants to try NC Spot Drill.
- Included one insert on tool holder and five inserts in the pocket.
- Total 6 inserts are equal to 24 spot drills.

Code	Parts No.	Ød	Insert included	Content
603201-3401	00-99616-10-ME6	10	N9MT080208CT-NC40	1 tool holder + 6 inserts + 1 key 
603201-3403	00-99616-10-ME6AL	10	N9MT080204CT-NC10	
613201-3401	00-99616-10-IN6	3/8"	N9MT080208CT-NC40	
613201-3403	00-99616-10-IN6AL	3/8"	N9MT080204CT-NC10	

► Comparison >>

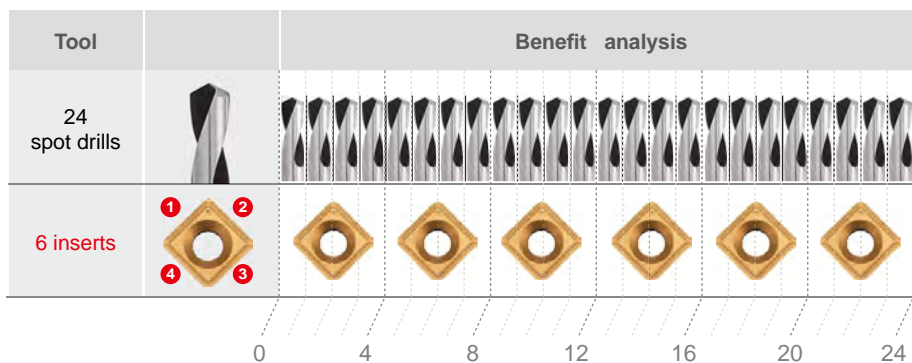

Note: N9MT080201W Engraving , see page 3-72.



90° N9MT11T3



► Inserts >>

- NC40:**
 - Wiper design, universal grade for all unhardened steel.
 - Each insert has 4 cutting edges.
- NC10:**
 - High positive angle and fully ground cutting edge and relief angle.
 - Universal grade for non-ferrous metal, cast iron and stainless steel.
 - Each insert has 4 cutting edges.
- NC60:**
 - Wiper design cermet insert, for hardened steel up to 56 HRC.
 - Each insert has 4 cutting edges.
- H-NC5071:**
 - For carbon steel C>0.3%, high alloy steel C>0.3% and cast iron.
 - Each insert has 2 cutting edges.
- H-NC40:**
 - For carbon steel C<0.3%, low alloy steel C<0.3%, stainless steel, non-ferrous and titanium.
 - Each insert has 2 cutting edges.
- H-NC9076:**
 - High positive geometry and sharp edge.
 - For non-ferrous material such as aluminum, titanium, brass, copper and long cutting chip metal.
 - Produces excellent surface finish on non-ferrous metal.
 - Each insert has 2 cutting edges.

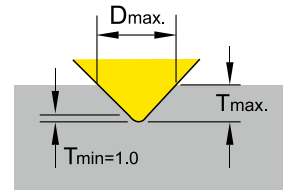

NC40 / Wiper design / NC60

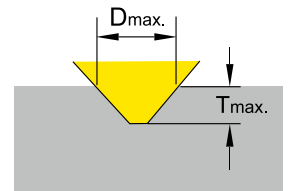

Other grade

Code	Parts No.	Coating	Grade	Re	Dimensions			Dmax.	Tmax.
					L	S	Re		
014401	NC40	TiN	P35		11.11	3.97	14	7	0.8
014402	NC10	TiAlN	K10F						(0.3)
014403	NC60	CERMET							0.8
014234	H-NC5071	TiAlN & TiN	K20F						0.8
014202	H-NC40	TiN	K20F						0.8
014203	H-NC9076	DLC	K20F						0.8

* H type is with supporting edge.

► Holder >>

- Single cutting edge design gives higher precision when spotting.
- Applications :
 - Spotting, engraving, grooving and chamfering on milling machines, machining centers.
 - Spotting, facing on CNC Lathes.

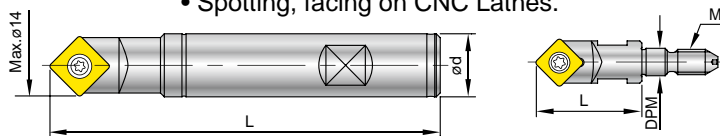

Code	Parts No.	Ød	L	M	DPM	Screw	Key
604002	00-99616-14-12	12	100	-	-	NS-35080 2.5 Nm	NK-T15
604004	00-99616-14	16	100	-	-		
604007	00-99616-14-150L	16	150	-	-		
604009	00-99616-14-220L	20	220	-	-		
614001	00-99616-14-1/2	1/2"	100	-	-		
614002	00-99616-14-5/8	5/8"	100	-	-		
624001	00-99616-14-M8	-	30	M8xP1.25	8.5		

• Refer to Page 9-156 for extension bars.

2

NC Spot Drill

N9MT11T3

90°



► Single Set >>

Code	Parts No.	Ød	Total Length	Insert fitted	Dmax.	Tmax.
604104-4401	00-99616-14-02S	16	100	N9MT11T3CT-NC40	14	7
604104-4402	00-99616-14-02SAL			N9MT11T3CT-NC10	14	7
614102-4401	00-99616-14-5/8-02S	5/8"	100	N9MT11T3CT-NC40	0.551"	0.276"
614102-4402	00-99616-14-5/8-02SAL			N9MT11T3CT-NC10	0.551"	0.276"

2

NC Spot Drill

► Starter Package >>

- Selected package for starter who wants to try NC Spot Drill.
- Included one insert on tool holder and five inserts in the pocket.
- Total 6 inserts are equal to 24 spot drills.

Code	Parts No.	Ød	Insert included	Content
604204-4401	00-99616-14-ME6	16	N9MT11T3CT-NC40	1 tool holder + 6 inserts + 1 key
604204-4402	00-99616-14-ME6AL		N9MT11T3CT-NC10	
614202-4401	00-99616-14-IN6	5/8"	N9MT11T3CT-NC40	
614202-4402	00-99616-14-IN6AL		N9MT11T3CT-NC10	



► Comparison >>

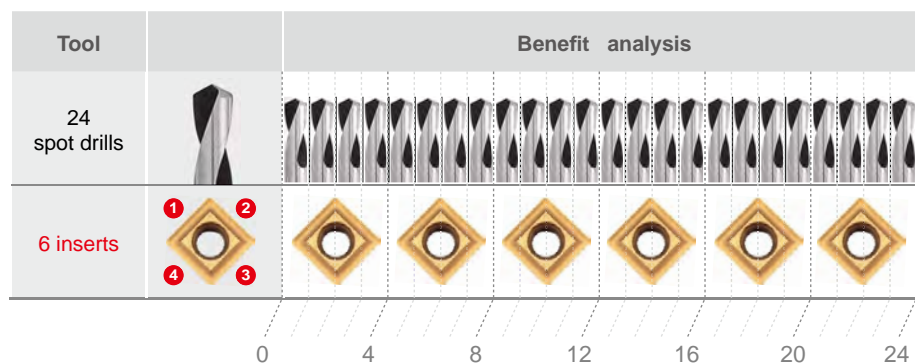

Low Cost! Economy!

1 2
4 3

6 inserts
12 inserts
24 inserts

24 spot drills
48 spot drills
96 spot drills

90° N9MT1704

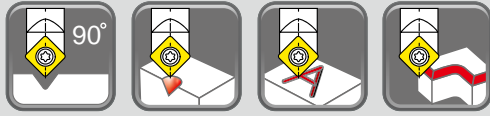

► Inserts >>

- 90 degree indexable spot drill insert, Dmax. 22mm.

- NC5071:**
- High positive geometry, fully ground cutting edge and relief angle.
 - For high alloy steel and cast iron.
 - Each insert has 2 cutting edges.

- NC9036:**
- For non-ferrous material such as aluminum, acrylic, brass, copper, titanium and long cutting chip materials.
 - High positive geometry and sharp edge produces excellent surface finish.
 - Each insert has 2 cutting edges.

- NC2071:**
- For carbon steel, low alloy steel, stainless steel, non-ferrous and titanium.
 - Each insert has 2 cutting edges.

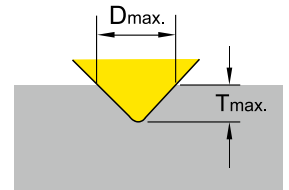

Code	Parts No.	Coating	Grade	Diagram	Dimensions			Dmax.	Tmax.
					L	S	Re		
016216	NC5071	TiAlN & TiN	K20F		17	4.76	1.2	22	10.4
016211	N9MT1704CT NC9036	DLC	K20F						
016201	NC2071	TiN	K20F						

► Holder >>

- Single cutting edge design gives high precision when spotting.
- Applications : • Spotting, engraving, grooving and chamfering on milling machines, machining centers.
- Spotting, facing on CNC Lathes.

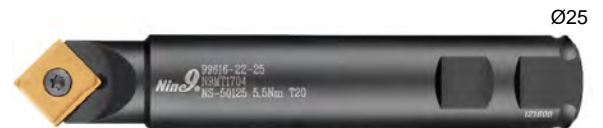
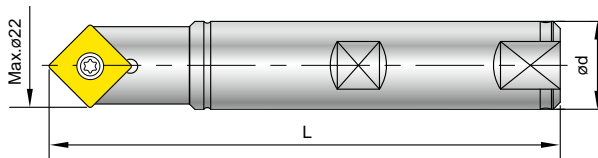

Code	Parts No.	Ød	L	Screw	Key
606001	00-99616-22	20	100	NS-50125 5.5 Nm	NK-T20
606002	00-99616-22-25	25	150		

2

NC Spot Drill

N9MT220408 / N9MT2506

90°

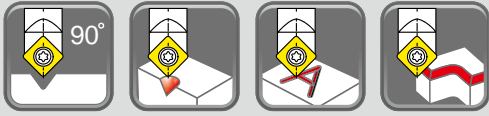

► N9MT220408

- NC40:**
- Universal grade for carbon steel, alloy steel and cast iron.
 - Each insert has 3 cutting edges.

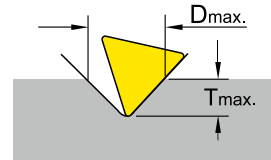

Code	Parts No.	Coating	Grade		Dimensions			Dmax.	Tmax.
					L	S	Re		
017301	N9MT220408CT-NC40	TiN	P35		20.83	4.76	---	25	12.2

* 5 pcs per box.

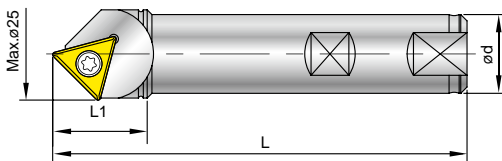

Code	Parts No.	Ød	L	L1	Screw	Key
607001	00-99616-25-CT28	25	120	30	NS-40100 3.5 Nm	NK-T15
617001	00-99616-1-CT28	1"				

► N9MT2506 >>

- NC2033:**
- For carbon steel, alloy steel, high alloy steel, cast iron and hardened steel < 50 HRC.
 - Each insert has 2 cutting edges.
- XP9000:**
- High positive geometry and sharp edge produces excellent surface finish.
 - For non-ferrous material such as aluminum, titanium, brass, copper and long cutting chip metal.
 - Each insert has 2 cutting edges.

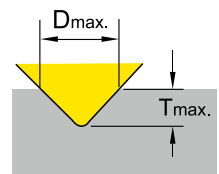

Code	Parts No.	Coating	Grade		Dimensions			Dmax.	Tmax.
					L	S	Re		
018201	N9MT2506CT	NC2033	TiAlN		25	6.35	1.2	32	15.4
018202		XP9000	Uncoated						

* 2 pcs per box.

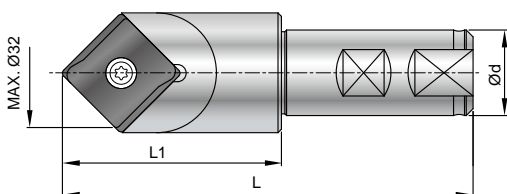

Code	Parts No.	Ød	L	L1	Screw	Key
608001	00-99616-32-25	25	120	64	NS-60180 5.5 Nm	NK-UT25
618001	00-99616-32-1	1"				

2
NC Spot Drill

100° N9MT11T3CT2T-H



► Inserts >>

• For aircraft 100° normal rivet hole and screw hole.

H-NC5071: • For carbon steel C>0.3%, high alloy steel C>0.3% and cast iron.
• Each insert has 2 cutting edges.

H-NC40: • For carbon steel C<0.3%, low alloy steel C<0.3%, stainless steel, non-ferrous and titanium.
• Each insert has 2 cutting edges.

H-NC9076: • High positive geometry and sharp edge.
• For non-ferrous material such as aluminum, titanium, brass, copper and long cutting chip metal.
• Produces excellent surface finish when chamfering non-ferrous metal.
• Each insert has 2 cutting edges.

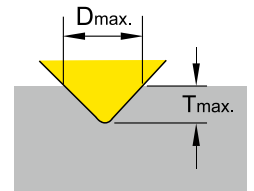
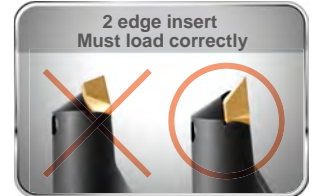

Code	Parts No.	Coating	Grade	Diagram	Dimensions			Dmax.	Tmax.
					L	S	Re		
014234	H-NC5071	TiAlN & TiN	K20F		11	3.97	0.8	16	6.3
014202	H-NC40	TiN							
014203	H-NC9076	DLC							

* H type is with supporting edge.

► Holder >>

• Spotting produces better hole position and geometrically uniform holes.
• Increase tool life of the next drilling operation.

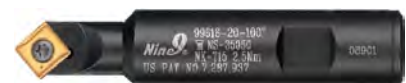
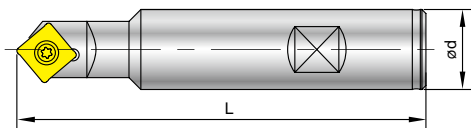

Code	Parts No.	Ød	L	Screw	Key
604011	00-99616-20-100	20	100	NS-35080 2.5 Nm	NK-T15

2

NC Spot Drill

V14208 / V14216

142°

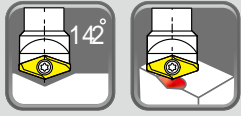

► Inserts >>

- For spotting before drilling by 135° - 140° point angle high performance drill.
- 142 degree indexable spotting drills. Dmax. 32mm.

- NC2071:**
- High positive geometry, fully ground cutting edge and relief angle.
 - Universal grade for all unhardened steel and cast iron.
 - Each insert has 2 cutting edges.

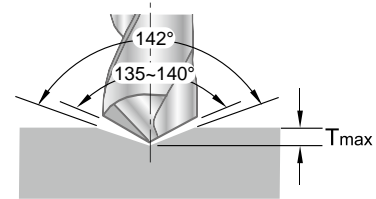

Code	Parts No.	Coating	Grade	Diagram	Dimensions			Dmax.	Tmax.
					L	S	Re		
0114201	V1420803-NC2071	TiN	K20F		8	2.38	0.8	16	2.8
0114211	V1421604-NC2071				14	4.76	1.2	32	5.5

The quantity of insert per box.:	V1420803	V1421604
	10	5

► Holder >>

- Spotting produces better hole position and geometrically uniform holes.
- Extend your drill life with 142° spotting. Reduce your drilling cost.
- Higher accuracy of positioning and diameter tolerance !

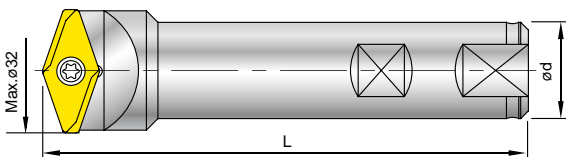

Code	Parts No.	Ød	L	Insert Type	Screw	Key
696001	00-99619-V142-16	16	100	V1420803	NS-30072 2.0 Nm	NK-T9
696002	00-99619-V142-32	25	120	V1421604	NS-50125 5.5 Nm	NK-T20

2

NC Spot Drill

145°
+
90°

WSP Spotting New Geometry of Spotting Tool



▶ Inserts >>

- NC2033:**
- Fully ground cutting edge and relief angle.
 - Universal grade for steel, cast iron and hardened steel < 50 HRC.
 - Each insert has 2 cutting edges.

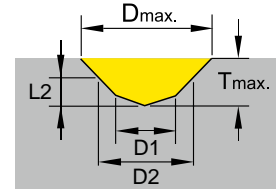

Code	Parts No.	Coating	Grade	Thread Size	Dimensions			Dmax.	Tmax.
					*D1±0.05	D2	L2		
013203	N9MT0802M04C-NC2033	TiAlN	K20F	M4x0.7	3.30	4.20	0.93	8	2.83
013204	N9MT0802M05C-NC2033			M5x0.8	4.20	5.25	1.14		2.52
013205	N9MT0802M06C-NC2033			M6x1.0	5.00	6.30	1.39		2.24
014219	N9MT11T3M08C-NC2033	TiAlN	K20F	M8x1.25	6.80	8.40	1.81	13	4.11
014220	N9MT11T3M10C-NC2033			M10x1.5	8.50	10.50	2.28		3.53
014221	N9MT11T3UNC25-NC2033	TiAlN	K20F	1/4-20 UNC	5.08	6.70	1.55	13	4.70
014222	N9MT11T3UNC31-NC2033			5/16-18 UNC	6.53	8.40	1.90		4.20
014223	N9MT11T3UNC38-NC2033			3/8-16 UNC	7.94	10.00	2.22		3.72
016205	N9MT1704M12C-NC2033	TiAlN	K20F	M12x1.75	10.25	12.60	2.91	20	6.61
016206	N9MT1704M14C-NC2033			M14x2.0	12.00	14.70	3.22		5.87
016207	N9MT1704M16C-NC2033			M16x2.0	14.00	16.80	3.51		5.11

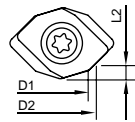

Note: *D1 refer to the Tap Pre-drilling sizes. D2 : Thread size x 5%. L2 : Depth of D2., see page 2-35 for example.

▶ Holder >>

- Utilizes standard **NC Spot Drill** basic holder.
- Holders and inserts are interchangeable.

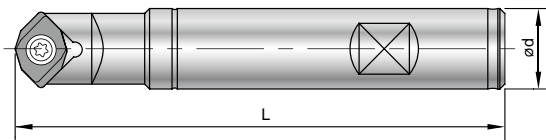

Code	Parts No.	Ød	L	Insert Type	Screw	Key
603001	00-99616-10	10	89.08±0.29	N9MT0802	NS-30055 2.0Nm	NK-T8
613001	00-99616-3/8	3/8"				
604004	00-99616-14	16	97.55±0.55	N9MT11T3	NS-35080 2.5Nm	NK-T15
614002	00-99616-14-5/8	5/8"				
606001	00-99616-22	20	96.24±0.64	N9MT1704	NS-50125 5.5Nm	NK-T20
616001	00-99616-22-3/4	3/4"				

2

NC Spot Drill - WSP

Performance

► Combined spotting and chamfering 145° + 90° >>

- Reduces process to one operation. Shorten cycle time.
- Use to spot prior to drilling with high performance drills for higher accuracy of hole position.
- Good support spotting process for round parts.

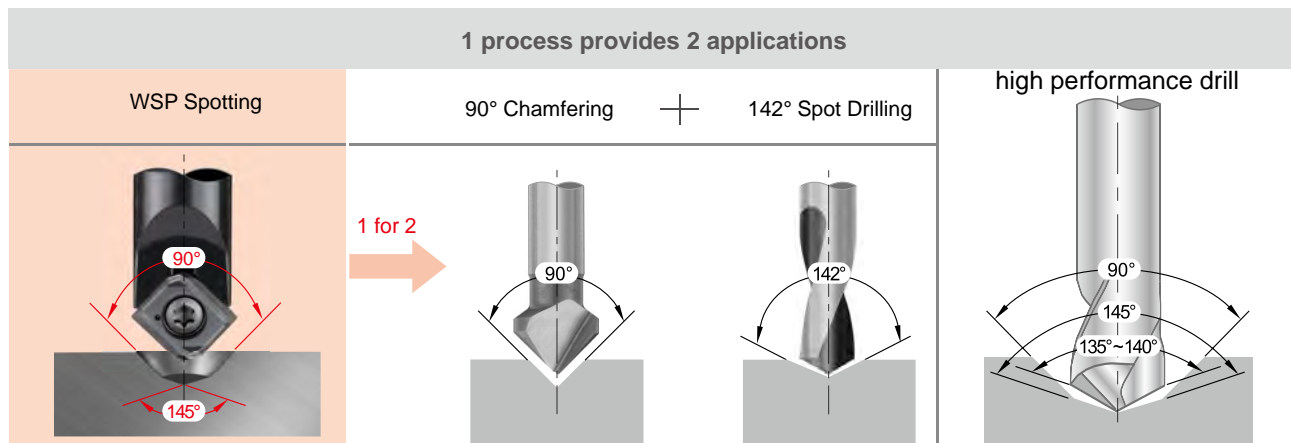

► Comparison >>

WSP Spotting + Drill	Drill + Spotting	Step Drill
<ul style="list-style-type: none"> • Shorter drilling time • Guided at the strongest corner of drill • Longer tool life • Good position accuracy 	<ul style="list-style-type: none"> • Longer drilling time • Guided at the weakest corner of drill • Shorter tool life 	<ul style="list-style-type: none"> • Tool cost is high • Shorter tool life • Can't drill directly from solid on round parts. • Bad position accuracy.

► Example >>

- The recommended chamfering is 5% of the nominal diameter of the thread, for example 6.3 mm for M6 thread.
- If you need larger chamfer, it can be calculated the required depth of spotting.

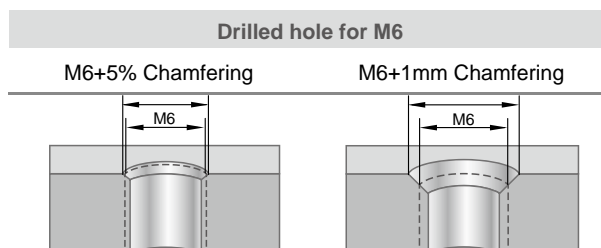



Corner Rounding >>>

Type of RC / Radius 0.5 ~10mm

Produces smooth and excellent surface finish on workpiece.

P M K N S

► Various Corner Radius Inserts
Can Fit On Same Holder.

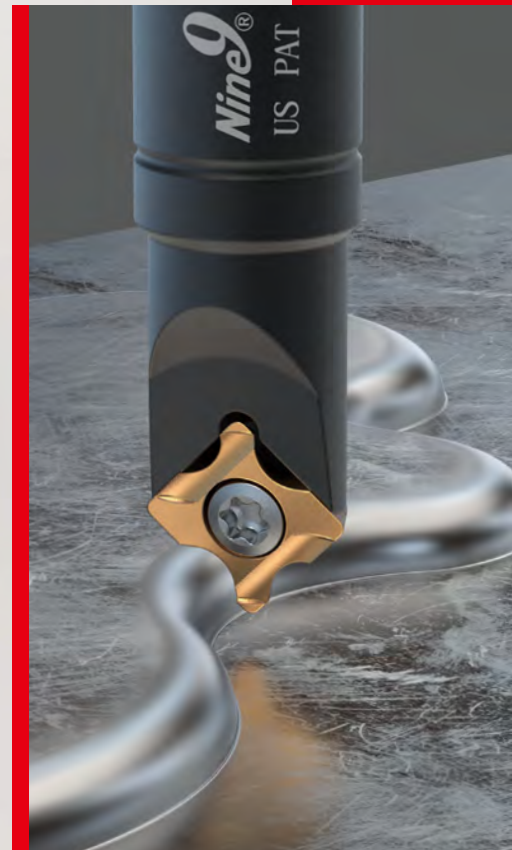

Features >

► Each Insert Has 2 Or 4 Cutting Edges

- Carbide insert can stand very long tool life.
- Each insert has 2 cutting edges.
- Combination corner rounding and 45° chamfering application on same insert.
- Higher cutting speed and feed rate.
- Very small X offset, good for contour chamfering.
- Utilizes standard NC Spot Drill holders 99616-06, 99616-14, 99616-22 & 99616-32.

► Example

- a** Radius 0.5
- b** Radius 1.0
- c** Radius 2.0

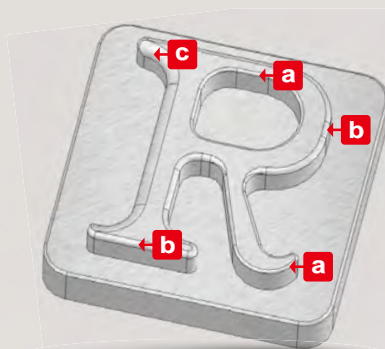

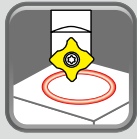

RC0.5 ~ RC1.0

▶ Inserts >>

- Various corner radius inserts can fit on same holder.
- Very small X offset 1.25mm for radius 0.5, the small x offset allows for profiling in small corners.

NC2071:

- Universal grade for all unhardened steel and cast iron.
- Inserts are CNC ground for precision radius location.
- Each insert has 2 cutting edges.

NC9036:

- For non-ferrous material such as aluminum, acrylic, titanium, brass, copper and stainless steel.
- High positive geometry and sharp edge produces excellent surface finish.
- Each insert has 2 cutting edges.

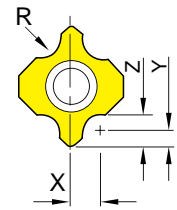

Corner Radius	Code	Parts No.		Coating	Grade	offset			Dimensions	
						X	Y	Z	L	S
0.5	011203	N9MT05T1RC05	NC2071	TiN	K20F	1.25	0.75	1.25	5	1.8
	011206		NC9036	DLC						
0.75	011204	N9MT05T1RC075	NC2071	TiN	K20F	1.50	0.75	1.50		
	011207		NC9036	DLC						
1.0	011205	N9MT05T1RC10	NC2071	TiN	K20F	1.75	0.75	1.75		
	011208		NC9036	DLC						

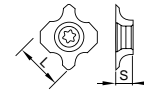

▶ Holder >>

- For corner rounding using **NC Spot Drill** basic holder.

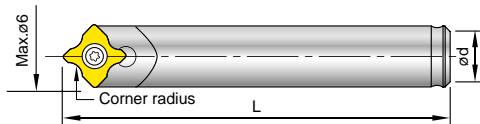

Code	Parts No.	Ød	L	Screw	Key
601001	00-99616-06-6	6	35	*NS-20036 0.6 Nm	NK-T6
601002	00-99616-06-5	5	35		
601003	00-99616-06-6L	6	60		

Note: 601003 is carbide shank holder.

*Torque screwdriver is recommended.

RC N9MT11T3RC



RC1.0 ~ RC3.0

► Inserts >>

- Combination corner rounding and 45° chamfering application on same insert.
- Each insert has 2 cutting edges.

NC40: • Universal grade for all unhardened steel and cast iron.

- Inserts are CNC ground for precision radius location.

NC9036: • For non-ferrous material such as aluminum, acrylic, titanium, brass, copper and stainless steel.

- High positive geometry and sharp edge produces excellent surface finish.

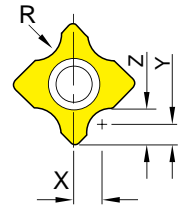

Corner Radius	Code	Parts No.		Coating	Grade	offset			Dimensions	
						X	Y	Z	L	S
1.0	014209	N9MT11T3RC10	NC40	TiN	K20F	2.75	1.5	2.5	11.11	3.97
	014224		NC9036	DLC						
1.5	014210	N9MT11T3RC15	NC40	TiN	K20F	3.25	1.5	3		
	014225		NC9036	DLC						
2.0	014211	N9MT11T3RC20	NC40	TiN	K20F	3.75	1.5	3.5		
	014226		NC9036	DLC						
2.5	014212	N9MT11T3RC25	NC40	TiN	K20F	4.25	1.5	4		
	014227		NC9036	DLC						
3.0	014213	N9MT11T3RC30	NC40	TiN	K20F	4.75	1.4	4.4		
	014228		NC9036	DLC						
1/64	014214	N9MT11T3RC1/64	NC40	TiN	K20F	0.086"	0.059"	0.0747"	0.437"	0.156"
	014229		NC9036	DLC						
1/32	014215	N9MT11T3RC1/32	NC40	TiN	K20F	0.101"	0.059"	0.090"		
	014230		NC9036	DLC						
1/16	014216	N9MT11T3RC1/16	NC40	TiN	K20F	0.133"	0.059"	0.122"		
	014231		NC9036	DLC						
3/32	014217	N9MT11T3RC3/32	NC40	TiN	K20F	0.164"	0.059"	0.153"		
	014232		NC9036	DLC						
1/8	014218	N9MT11T3RC 1/8	NC40	TiN	K20F	0.199"	0.055"	0.180"		
	014233		NC9036	DLC						

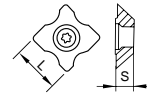

► Holder >>

- For corner rounding using **NC Spot Drill** basic holder.

Code	Parts No.	Ød	L	Screw/ Key
604002	00-99616-14-12	12	100	NS-35080 2.5 Nm /
604004	00-99616-14	16		
614001	00-99616-14-1/2	1/2"	100	NK-T15
614002	00-99616-14-5/8	5/8"		

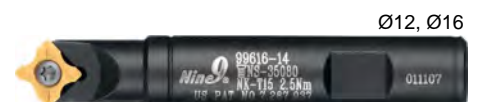
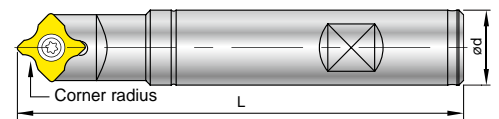

► Starter Package >>

Code	Parts No.	Ød	Insert included	Content
604204-4200	00-99616-14-ME5RC	16	N9MT11T3RC10-NC40 N9MT11T3RC15-NC40 N9MT11T3RC20-NC40 N9MT11T3RC25-NC40 N9MT11T3RC30-NC40	1 tool holder + 5 inserts + 1 key



2

Corner Rounding

N9MT1704RC / N9MT2506RC

RC



RC4.0 ~ RC6.0 /
RC7.0 ~ RC10.0

► N9MT1704RC >>

- NC2071:** • Universal grade for all unhardened steel and cast iron.
- NC9036:** • High positive geometry and sharp edge produces excellent surface finish.
• For non-ferrous material such as aluminum, acrylic, titanium, brass, copper and stainless steel.

Corner Radius(R)	Code	Parts No.		Coating	Grade	offset				Dimensions	
						X	Y	Z		L	S
4.0	016202	N9MT1704RC40	NC2071	TiN	K20F	6.15	2	6		17	4.76
	016208		NC9036	DLC							
5.0	016203	N9MT1704RC50	NC2071	TiN	K20F	7.1	2	7			
	016209		NC9036	DLC							
6.0	016204	N9MT1704RC60	NC2071	TiN	K20F	8.1	2	8			
	016210		NC9036	DLC							

► N9MT2506RC >>

- NC2033:** • For carbon steel, alloy steel, high alloy steel, cast iron and hardened steel < 50 HRC.
- XP9000:** • High positive geometry and sharp edge produces excellent surface finish.
• For non-ferrous material such as aluminum, titanium, brass, copper and long cutting chip metal.

Corner Radius(R)	Code	Parts No.		Coating	Grade	offset				Dimensions	
						X	Y	Z		L	S
7.0	018203	N9MT2506RC70	NC2033	TiAlN	K20F	9.5	3	10		25	6.35
	018204		XP9000	Uncoated							
8.0	018205	N9MT2506RC80	NC2033	TiAlN	K20F	10.5	3	11			
	018206		XP9000	Uncoated							
9.0	018207	N9MT2506RC90	NC2033	TiAlN	K20F	11.5	3	12			
	018208		XP9000	Uncoated							
10.0	018209	N9MT2506RC100	NC2033	TiAlN	K20F	12.5	3	13			
	018210		XP9000	Uncoated							
5/16	018213	N9MT2506RC5/16	NC2033	TiAlN	K20F	0.411"	0.118"	0.430"			
	018214		XP9000	Uncoated							
3/8	018211	N9MT2506RC3/8	NC2033	TiAlN	K20F	0.474"	0.118"	0.493"			
	018212		XP9000	Uncoated							

* 2 pcs per box.

► Holder >>

- For corner rounding using **NC Spot Drill** basic holder.

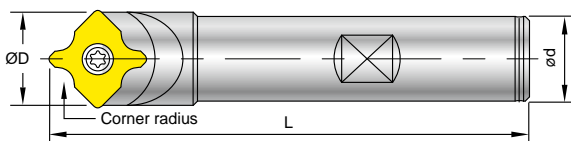

Code	Parts No.	Ød	L	ØD	Insert Type	Screw	Key
606001	00-99616-22	20	100	23.25	N9MT1704	NS-50125 5.5 Nm	NK-T20
606002	00-99616-22-25	25	150				
608001	00-99616-32-25	25	120	32.56	N9MT2506	NS-60180 5.5 Nm	NK-UT25
618001	00-99616-32-1	1"	120				



Corner Rounding >>>

Type of R / Radius 1.0~3.0mm

Produces smooth and excellent surface finish on workpiece.



- ▶ For Front And Back Chamfering (By LA Insert),
And Corner Rounding (By R Insert)



Features >

▶ Each Insert Has 4 Cutting Edges

- Carbide insert can stand very long tool life.
- R1.0 ~ R3.0 inserts are interchangeable on same holder.
- For front and back chamfering.
- Tool offset can be set after measuring tool length by tool presetter or Z-Zero Setter.
- Inserts are CNC ground for precision radius and location.
- Optimizes the tool performance and reduces the cutting time.





R1.0~R3.0

► Inserts >>

- For front and back corner rounding.
- Various corner radius inserts can fit on same holder.
- Coated carbide inserts for excellent tool life.
- Each insert has 4 cutting edges.

NC2071: • Universal grade for all unhardened steel and cast iron.
• Inserts are CNC ground for precision radius location.

Corner Radius(R)	Code	Parts No.	Coating	Grade		Dimensions	
						L	S
1.0	014404	N9MT11T3R10-NC2071	TiN	P35		11.11	3.97
1.5	014405	N9MT11T3R15-NC2071	TiN	P35			
2.0	014406	N9MT11T3R20-NC2071	TiN	P35			
2.5	014407	N9MT11T3R25-NC2071	TiN	P35			
3.0	014408	N9MT11T3R30-NC2071	TiN	P35			

► Holder >>

- Center of radius of each tool is dedicated.
- Tool offset can be set after measuring tool length by tool presetter or Z-Zero Setter.

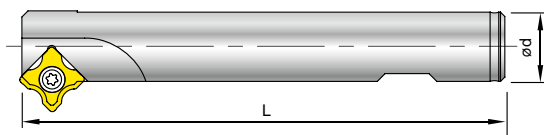

Code	Parts No.	Ød	L	Z	Screw	Key
604015	00-99616-16-25R	16	100	1	NS-35080 2.5 Nm	NK-T15
604019	00-99616-16-30R	16	120	1		
604020	00-99616-25-40R	25	150	4		

► More >>

- Also can fit with N9MT11T308LA inserts for front and back chamfering. (Please see page 2-43)

R N9MT11T3R

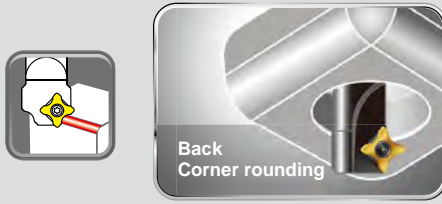

► Cutting Position >>

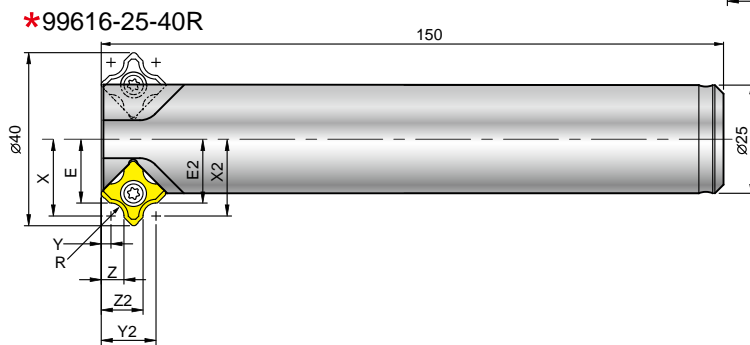
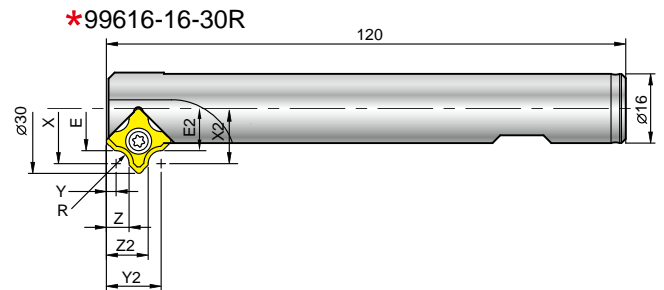
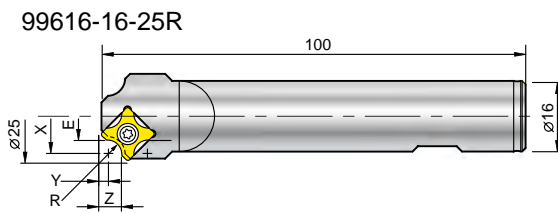

* 99616-16-30R & 99616-25-40R
For front and back corner rounding.
Eliminates 2nd operation or deburring time.

Corner Radius	Holder	Front Chamfering				Back Chamfering				⊕ Z
		E	X	Y	Z	E2	X2	Y2	Z2	
R1.0	00-99616-16-25R	8.25	9.25	3.25	4.25	---	---	---	---	1
	00-99616-16-30R	10.75	11.75	3.25	4.25	10.75	11.75	11.65	10.65	1
	00-99616-25-40R	15.75	16.75	3.25	4.25	15.75	16.75	11.65	10.65	4
R1.5	00-99616-16-25R	8	9.5	3	4.5	---	---	---	---	1
	00-99616-16-30R	10.5	12	3	4.5	10.5	12	11.9	10.4	1
	00-99616-25-40R	15.5	17	3	4.5	15.5	17	11.9	10.4	4
R2.0	00-99616-16-25R	7.75	9.75	2.75	4.75	---	---	---	---	1
	00-99616-16-30R	10.25	12.25	2.75	4.75	10.25	12.25	12.15	10.15	1
	00-99616-25-40R	15.25	17.25	2.75	4.75	15.25	17.25	12.15	10.15	4
R2.5	00-99616-16-25R	7.5	10	2.5	5	---	---	---	---	1
	00-99616-16-30R	10	12.5	2.5	5	10	12.5	12.4	9.9	1
	00-99616-25-40R	15	17.5	2.5	5	15	17.5	12.4	9.9	4
R3.0	00-99616-16-25R	7.25	10.25	2.25	5.25	---	---	---	---	1
	00-99616-16-30R	9.75	12.75	2.25	5.25	9.75	12.75	12.65	9.65	1
	00-99616-25-40R	14.75	17.75	2.25	5.25	14.75	17.75	12.65	9.65	4

2

Corner Rounding

N9MT11T308LA 45° Chamfering Tool



► Inserts >>

- NC40:**
 - General purpose, universal grade for all unhardened steel.
 - Each insert has 4 cutting edges.
- NC10:**
 - High positive angle and fully ground cutting edge and relief angle.
 - Universal grade for Al, Al-alloy, non-ferrous metal, cast iron and stainless steel.
 - Each insert has 4 cutting edges.
- NC60:**
 - Cermet insert, for hardened steel up to 56 HRC .
 - Each insert has 4 cutting edges.

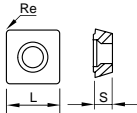
Code	Parts No.	Coating	Grade		Dimensions		
					L	S	Re
014409	N9MT11T308LA	NC40	TiN	P35	11.11	3.97	0.8
014410		NC10	TiAN	K10F			
014411		NC60	Cermet				

► Holder >>

- 00-99616-28 can be applied for machining back chamfering and side grooving.

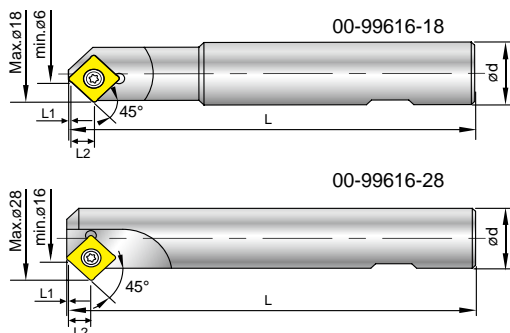

Code	Parts No.	Chamfering	Ød	L	L1	L2	Z	Insert type	Screw / Key
604017	00-99616-18	Ø6-Ø18	20	120	1.15	7.55	1	N9MT11T308LA	NS-35080 2.5 Nm
604018	00-99616-28	Ø16-Ø28	20	120	1.15	7.55	1		NK-T15

► Example >>

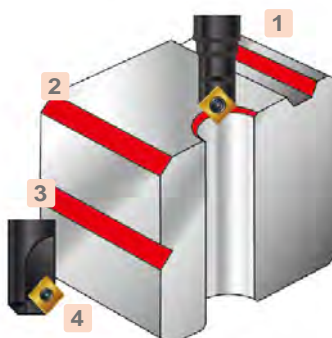
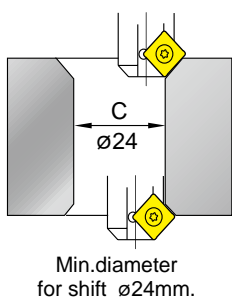
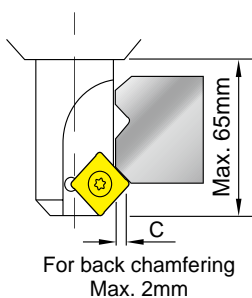

Action	
1	External and internal chamfering
2	Side chamfering
3	Side grooving
4	Back chamfering

► More >>

- Also can fit with 99616-XX-25R/30R/40R holders. (Please see page 2-42)

Cutting Data

► Diameter / Depth Chart and Speed / Feed Rate Calculation of NC Spot Drill

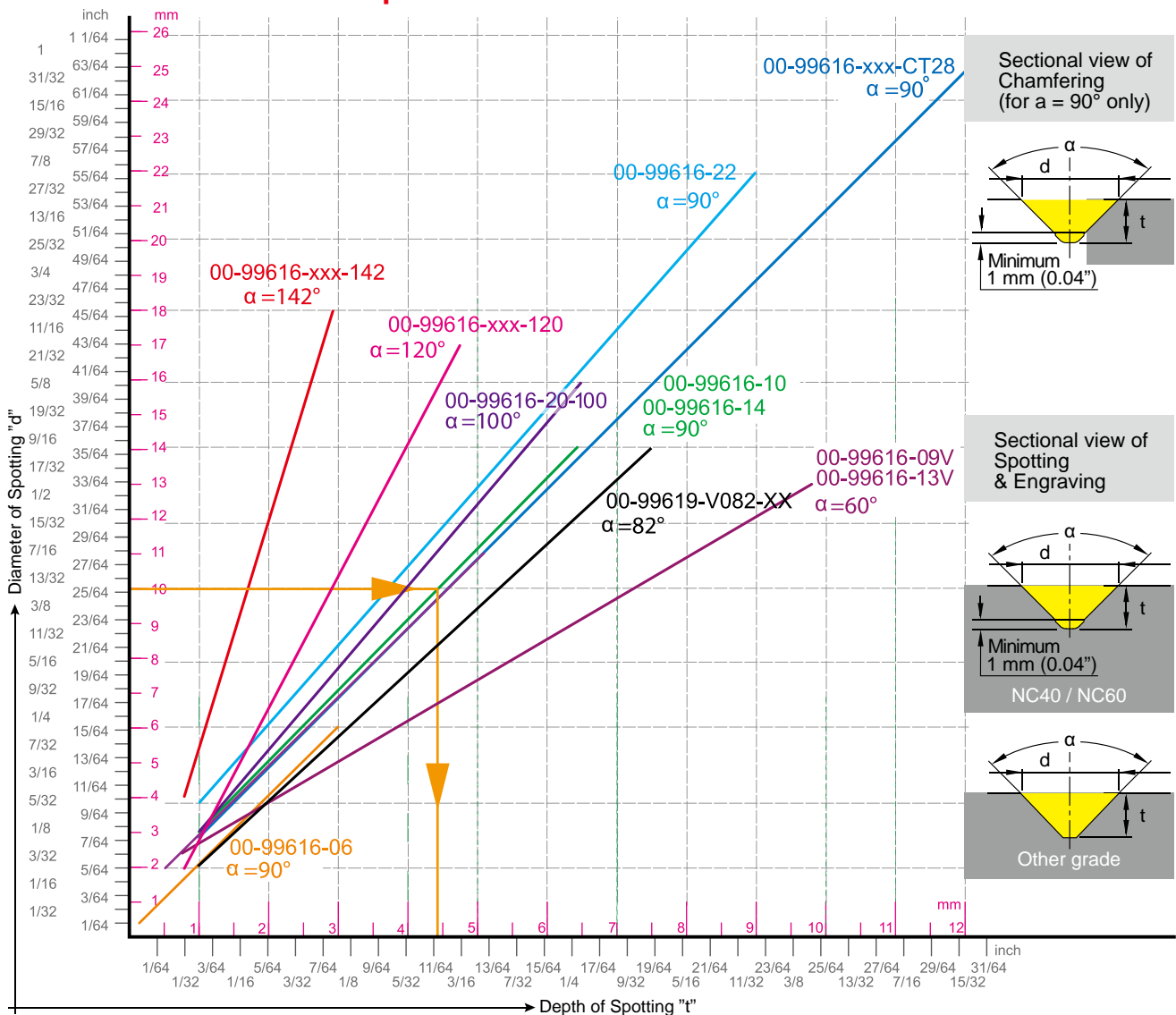

► Instruction >>

1. From Spot diameter "d" to get drill depth " t " .
2. Point angle "α" is determined by which tool holder you use.
3. From "d" draw a horizontal line to get intersection of the line by point angle "α".
4. From the intersection draw a vertical line to the bottom to have depth of spotting " t " . " t " is the drill depth of the NC program.
5. The sectional view of spotting will depend on the shape of insert, NC40 and other grades of inserts have different sectional view.
6. For chamfering, do not use tip of insert, 1mm(0.04'') minimum clearance is required for a smooth surface finish.

Metric	
$S = \frac{Vc \times 1000}{\pi \times d}$	d = diameter -mm S = Spindle Speed -r.p.m. Vc = Cutting Speed -m/min.
$F = S \times f$	f = mm/rev. F = mm/min.



Inch	
$S = \frac{(3.82 \times SFM)}{d}$	d = diameter-inch S = Spindle Speed-r.p.m. SFM = Surface Speed-ft./min.
$F = r.p.m. \times IPR$	f = IPR = inch/rev. F = inch/min.

Cutting Data

Determine spindle speed and feed rate:

- Choose spotting depth to decide spotting diameter according to the Diameter/Depth chart on page 2-44.
- The spindle speed should be calculated by the maximum diameter of spotting, chamfering and grooving.



► For Insert V9MT0802CT / N9MT05T1CT / N9MT0602CT

	Workpiece material	Vc (m/min)	f (mm/rev.)		NC2071	NC5071	NC9076
			 Spotting / Grooving	 Chamfering			
P	Carbon Steel C<0.3%	150 ~ 320	0.03 ~ 0.07	0.05 ~ 0.15	●		
	Carbon Steel C>0.3%	100 ~ 250	0.02 ~ 0.06	0.03 ~ 0.12		●	
	Low Alloy Steel C<0.3%	100 ~ 250	0.02 ~ 0.06	0.04 ~ 0.12	●		
	High Alloy Steel C>0.3%	60 ~ 180	0.02 ~ 0.05	0.03 ~ 0.10		●	
M	Stainless Steel	65 ~ 125	0.02 ~ 0.04	0.03 ~ 0.08	●	○	◎
K	Cast iron	150 ~ 250	0.03 ~ 0.07	0.05 ~ 0.15	◎	●	
N	Non-Ferrous Metal (Al, Cu)	150 ~ 320	0.03 ~ 0.07	0.05 ~ 0.15	◎		●
S	Ti, Ti-alloy	40 ~ 80	0.02 ~ 0.06	0.02 ~ 0.06	●		◎
	Ni-alloy	30 ~ 60	-	0.03 ~ 0.07	○	◎	
H	Hardened steel HRC 40°~56°	30 ~ 60	0.02 ~ 0.06	0.02 ~ 0.06		○	

* For technical construction reasons, the insert is not located on the center of the holder.

● Best ◎ Suit ○ Possible

► For Insert N9MT0802 / N9MT11T3CT

	Workpiece material	Vc (m/min)	f (mm/rev.)		NC40	NC10	NC60	H-NC5071	H-NC40	H-NC9076
			 Spotting / Grooving	 Chamfering						
P	Carbon Steel C<0.3%	150 ~ 320	0.05 ~ 0.10	0.10 ~ 0.24	●				●	
	Carbon Steel C>0.3%	100 ~ 250	0.04 ~ 0.08	0.08 ~ 0.20				●		
	Low Alloy Steel C<0.3%	100 ~ 250	0.04 ~ 0.08	0.08 ~ 0.20	●		◎		●	
	High Alloy Steel C>0.3%	60 ~ 180	0.03 ~ 0.07	0.05 ~ 0.15			◎	●		
M	Stainless Steel	65 ~ 125	0.03 ~ 0.06	0.08 ~ 0.20	○	●		○	●	◎
K	Cast iron	150 ~ 250	0.05 ~ 0.10	0.10 ~ 0.25	●	●		●	◎	
N	Non-Ferrous Metal (Al, Cu)	150 ~ 320	0.05 ~ 0.10	0.10 ~ 0.25		◎			◎	●
S	Ti, Ti-alloy	40 ~ 80	0.03 ~ 0.08	0.03 ~ 0.08					●	◎
	Ni-alloy	30 ~ 60	-	0.05 ~ 0.10				◎	○	
H	Hardened steel HRC 40°~56°	30 ~ 60	0.03 ~ 0.08	0.03 ~ 0.08			●	○		

* For technical construction reasons, the insert is not located on the center of the holder.

● Best ◎ Suit ○ Possible

* H-NC5071, H-NC40 and H-NC9076 inserts with supporting edges can increase feed rate 50%.

2

NC Spot Drill

Cutting Data

► For Insert V9MT12T3CT / V082... / N9MT1704CT / N9MT2204CT / N9MT2506CT / V142...

Workpiece material	Vc (m/min)	f (mm/rev.)		NC2071	NC5071	NC9076 (NC9036)	NC40	NC2033	XP9000
		Spotting / Grooving	Chamfering						
P Carbon Steel C<0.3%	150 ~ 320	0.05 ~ 0.10	0.10 ~ 0.24	●			●		
Carbon Steel C>0.3%	100 ~ 250	0.04 ~ 0.08	0.08 ~ 0.20		●			●	
Low Alloy Steel C<0.3%	100 ~ 250	0.04 ~ 0.08	0.08 ~ 0.20	●			●		
High Alloy Steel C>0.3%	60 ~ 180	0.03 ~ 0.07	0.05 ~ 0.15		●			●	
M Stainless Steel	65 ~ 125	0.03 ~ 0.06	0.08 ~ 0.20	●	○	⊙	○	○	
K Cast iron	150 ~ 250	0.05 ~ 0.10	0.10 ~ 0.25	⊙	●		⊙	●	
N Non-Ferrous Metal (Al, Cu)	150 ~ 320	0.05 ~ 0.10	0.10 ~ 0.25	⊙		●			●
S Ti, Ti-alloy	40 ~ 80	0.03 ~ 0.08	0.03 ~ 0.08	●		⊙			
Ni-alloy	30 ~ 60	-	0.05 ~ 0.10	○	⊙				
H Hardened steel HRC 40°~56°	30 ~ 60	0.03 ~ 0.08	0.03 ~ 0.08		○			⊙	

* For technical construction reasons, the insert is not located on the center of the holder.

● Best ⊙ Suit ○ Possible

► For Insert N9MT0802M.. / N9MT11T3M.. / N9MT11T3UNC.. N9MT1704M..

WSP spotting	Formula																						
	$P =$ distance of theoretical intersection point to tip of insert.																						
	$0.5 =$ fixed factor for calculation																						
	$L_{req.} =$ required drilling depth																						
	$D_{req.} =$ required diameter																						
	<table border="1"> <thead> <tr> <th>M4</th> <th>M5</th> <th>M6</th> <th>M8</th> <th>M10</th> <th>M12</th> <th>M14</th> <th>M16</th> <th>1/4-20 UNC</th> <th>5/16-18 UNC</th> <th>3/8-16 UNC</th> </tr> </thead> <tbody> <tr> <td>$P = 1.17$</td> <td>1.48</td> <td>1.76</td> <td>2.39</td> <td>2.97</td> <td>3.59</td> <td>4.19</td> <td>4.88</td> <td>1.80</td> <td>2.30</td> <td>2.78</td> </tr> </tbody> </table>	M4	M5	M6	M8	M10	M12	M14	M16	1/4-20 UNC	5/16-18 UNC	3/8-16 UNC	$P = 1.17$	1.48	1.76	2.39	2.97	3.59	4.19	4.88	1.80	2.30	2.78
M4	M5	M6	M8	M10	M12	M14	M16	1/4-20 UNC	5/16-18 UNC	3/8-16 UNC													
$P = 1.17$	1.48	1.76	2.39	2.97	3.59	4.19	4.88	1.80	2.30	2.78													

WSP spotting	Work Material	Vc (m/min)	f (mm/rev.)	Grade of Insert
P	Carbon steel	150 ~ 300	0.05 ~ 0.15	NC2033
	Alloy steel	120 ~ 250	0.05 ~ 0.10	NC2033
M	Stainless steel	80 ~ 150	0.04 ~ 0.08	NC2033
K	Casting iron	100 ~ 200	0.05 ~ 0.10	NC2033
H	Hardened steel up 50 HRC	30 ~ 60	0.03 ~ 0.08	NC2033

2

NC Spot Drill

Cutting Data

► For Insert N9MT05T1RC / N9MT11T3RC / N9MT1704RC / N9MT2506RC

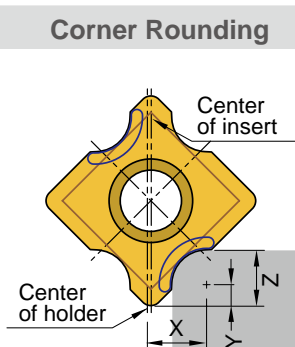

Corner Rounding		Calculate spindle speed	
$d = 2 \times X$	mm	$d =$	diameter of the tool
$S = \frac{Vc \times 1000}{d \times \pi}$	r.p.m.	$X =$	tool radius offset
$F = S \times f$	mm/min.	$Vc =$	Cutting Speed -m/min.
		$S =$	Spindle Speed -r.p.m.
		$F =$	mm/min.
		$f =$	mm/rev.

Calculate tool length offset on machining center	
$X =$	tool radius offset
$Y =$	distance to the center of radius.
$Z =$	distance of cut

RC Insert	Work Material	Vc (m/min)	f (mm/rev.)	Grade of Insert	
	P Carbon steel	150~320	0.05~0.10	NC40, NC2071, NC2033	
	Alloy steel	100~250	0.05~0.10	NC40, NC2071, NC2033	
	High alloy steel	80~150	0.04~0.08	NC40, NC2071, NC2033	
	M Stainless steel	65~125	0.03~0.08	NC9036	
	K Casting iron	150~250	0.05~0.10	NC40, NC2071, NC2033	
	N	Aluminum, Al-alloy Si < 12%	150~320	0.05~0.10	NC9036, XP9000
		Al-alloy Si > 12%	100~300	0.05~0.10	NC9036, XP9000
		Cu	200~250	0.05~0.10	NC9036, XP9000
		Brass and Bronze	150~250	0.05~0.10	NC9036, XP9000
	S Ti, Ti-alloy	40~80	0.03~0.08	NC9036	
	H Hardened steel < 50 HRC	30~60	0.03~0.08	NC2033	

2

Corner Rounding

► For N9MT-R Insert >> Corner Rounding (4 cutting edges)

R Insert	Work Material	Vc (m/min)	f (mm/rev.)	Grade of Insert
	P Carbon steel	150~320	0.05~0.10	NC2071
	Alloy steel	100~250	0.04~0.08	NC2071
	High alloy steel	60~80	0.03~0.06	NC2071
	K Casting iron	150~250	0.05~0.10	NC2071

► For LA Insert >> 45° Chamfering

45° Chamfering	Formula
	$\alpha =$ point angle 90°
$S = \frac{Vc \times 1000}{d \times \pi}$	r.p.m.
$F = S \times f$	mm/min.
	$d =$ effective diameter
	$Vc =$ cutting speed-m/min.or ft/min.
	$S =$ Spindle speed
	$f =$ feed per rev.-mm/rev.

45° Chamfering	Work Material	Vc (m/min)	f (mm/rev.)	Grade of Insert	
	P Carbon steel	150~320	0.05~0.10	NC40	
	Alloy steel	100~250	0.04~0.08	NC40	
	High alloy steel	60~80	0.03~0.06	NC40	
	M Stainless steel	65~125	0.03~0.06	NC10	
	K Casting iron	150~250	0.05~0.10	NC10, NC40	
	N	Aluminum, Al-alloy Si < 12%	150~320	0.05~0.10	NC10
		Al-alloy Si > 12%	100~300	0.05~0.10	NC10
		Cu	200~250	0.05~0.10	NC10
		Brass and Bronze	150~250	0.05~0.10	NC10
	H Hardened steel 40~56 HRC	60~80	0.05~0.10	NC60	



i-Center®

Center Drill >>>

The "i-Center" is a trademark of Nine9, the developer of the first indexable center drill in the world. (Patented) Offering an indexable insert system for the 1st time, Nine9's "i-Center" design improves your process performance.



- 2 cutting flutes design same as carbide center drill for high performance speed and feed rate.
- Each insert has 2 cutting edges.

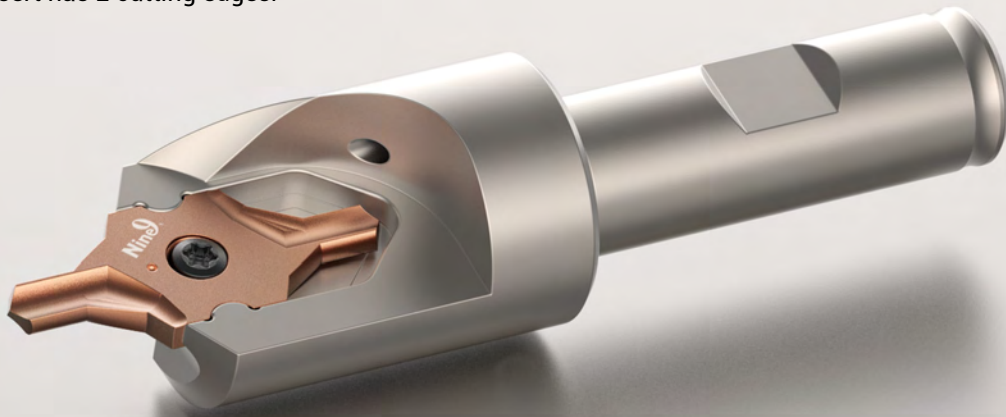

Features >>>

▶ High Speed, High Feed Rate

- The special ground insert and rigid holder design facilitate high performance speed and feed rates. For example, drilling alloy steel at 6000 rpm and feed rate of 600 mm/min. (0.1 mm/rev.)

▶ Excellent Repeatability

- The positioning repeatability of the insert is within 0.02 mm (.0008") in radial direction, thus ensuring conformity to any national standards.

▶ Easy Tool Length Setting

- The axial position accuracy of the insert is 0.05 mm (.002"). It is not necessary to reset the tool length when changing the insert or cutting edge.

▶ Extended Tool Life

- Coolant can be supplied through the center of the holder to increase performance and extend tool life.
- Insert geometry, grades and coating process are specifically engineered for centering applications.



Applications

DIN 332 Form R

Ø1.0~Ø10

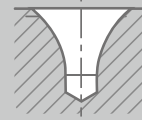

DIN 332 Form A

Ø2.0~Ø3.15

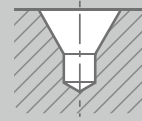

DIN 332 Form A+B

Ø1.0~Ø10

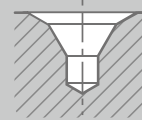

ANSI 60°

#2.0~#10

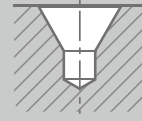

Excellent repeatability
No need tool length
re-setting while changing
insert or cutting edge.

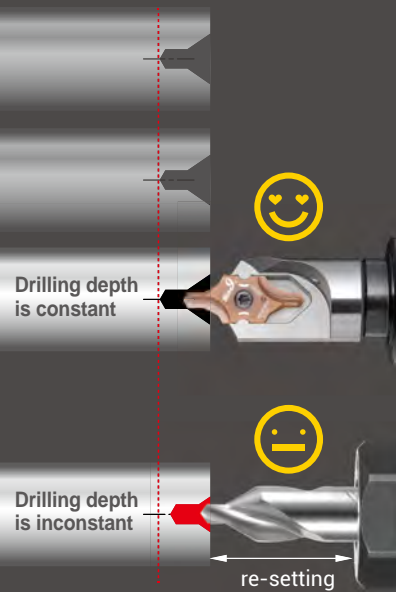



2

i-Center

“ World’s first indexable center drill.
Shortens set up and
center drilling time.
Increases tool life and
reduces tooling costs. ”



- NC2057**  • P35 grade, AlTiN + TiSiN coating, Universal grade for all kind of steel.
• Double-edged cutting, fully ground insert for improving machining stability. (IC10 inserts)
- NC5074**  • P40 grade, Helica (AlCrN) coating,
design for small diameter center drill (IC08 inserts).
- NC2033**  • K20F grade, TiAlN coated, for carbon steel, alloy steel,
high alloy steel and cast iron.

DIN332 Form R

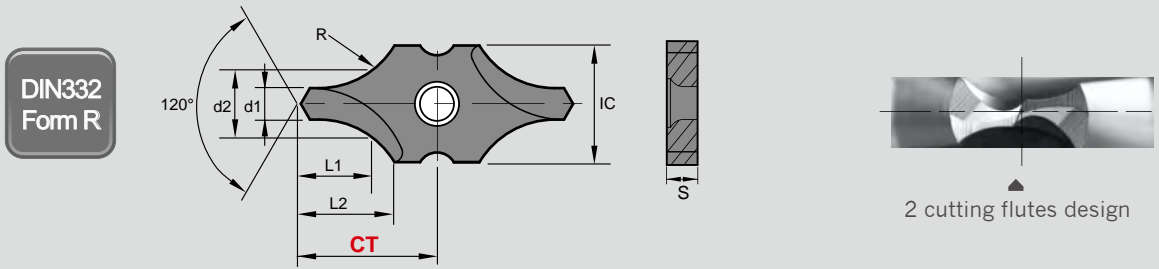

► For DIN332
Form R Center Hole >>

2

i-Center

IC	Code	Parts No.	Coating	Grade	d1	d2	L1	L2	R	S	CT ±0.025	
08	032211	I9MT08T1R0100-NC5074	Helica	P40	1.00	+ 0.14 0	2.12	2.16	4.14	2.8	2.00	7.55
	032212	I9MT08T1R0125-NC5074			1.25		2.65	2.74	4.64	3.5		7.90
	032213	I9MT08T1R0160-NC5074			1.60		3.35	3.45	5.13	4.5		8.40
	032214	I9MT08T1R0200-NC5074			2.00		4.25	4.45	6.08	5.65		9.10
10	031200	I9MT1003R0100-NC2057	AlTiN+ TiSiN	P35	1.00	+ 0.14 0	2.12	2.16	4.72	2.8	3.00	12.35
	031201	I9MT1003R0125-NC2057			1.25		2.65	2.74	5.22	3.5		
	031202	I9MT1003R0150-NC2057			1.50		3.60	3.67	6.14	5.0		
	031203	I9MT1003R0160-NC2057			1.60		3.35	3.45	5.32	4.5		
	031204	I9MT1003R0200-NC2057			2.00	4.25	4.45	6.50	5.65			
	031205	I9MT1003R0250-NC2057			2.50	5.30	5.59	7.66	7.15			
	031206	I9MT1003R0300-NC2057			3.00	+ 0.18 0	5.70	6.92	9.50	10.00		
	031207	I9MT1003R0315-NC2057			3.15		6.70	7.21	8.93	9.00		
12	033201	I9MT12T2R0200-NC2033	TiAlN	K20F	2.00	+ 0.14 0	4.25	4.45	6.64	5.65	2.54	11.73
	033202	I9MT12T2R0250-NC2033			2.50		5.3	5.59	8.11	7.15		13.00
	033203	I9MT12T2R0315-NC2033			3.15		6.7	7.21	9.63	9.0		14.00
16	034201	I9MT1603R0400-NC2033	TiAlN	K20F	4.00	+ 0.18 0	8.5	9.06	12.23	11.0	3.18	19.40
	034202	I9MT1603R0500-NC2033			5.00		10.6	11.45	14.2	14.0		19.40
20	035201	I9MT2004R0630-NC2033	TiAlN	K20F	6.30	+ 0.22 0	13.2	14.63	18.2	18.0	4.76	28.40
	035202	I9MT2004R0800-NC2033			8.00		17.0	18.63	20.44	22.5		28.30
25	036201	I9MT2506R1000-NC2033	TiAlN	K20F	10.00		21.2	23.51	25.8	28.0	6.35	34.20

The quantity of insert per box.:

IC 08	IC 10	IC 12	IC 16	IC 20	IC 25
5	5	5	2	1	1

DIN332 Form A+B

DIN332
Form A+B

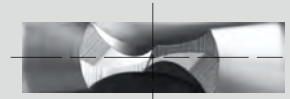
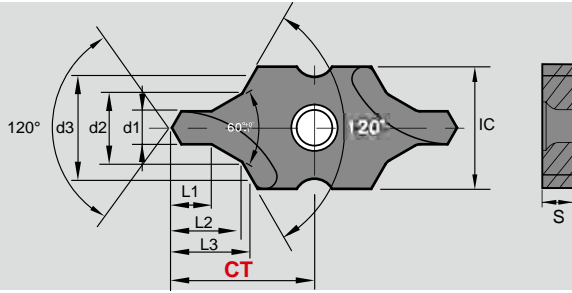

2 cutting flutes design



► For DIN332
Form A+B Center Hole >>

2

i-Center

IC	Code	Parts No.	Coating	Grade	d1	d2	d3	L1	L2	L3	S	CT ±0.025		
08	032011	I9MT08T1B0100-NC5074	Helica	P40	1.00	+0.14 0	2.12	3.15	1.3	2.21	2.51	2.00	7.55	
	032012	I9MT08T1B0125-NC5074			1.25		2.65	4.0	1.6	2.75	3.14		7.90	
	032013	I9MT08T1B0160-NC5074			1.60		3.35	5.0	2.0	3.46	3.93		8.40	
	032014	I9MT08T1B0200-NC5074			2.00		4.25	6.3	2.5	4.39	4.98		9.10	
10	031000	I9MT1003B0100-NC2057	AlTiN+ TiSiN	P35	1.00	+0.14 0	2.12	3.15	1.3	2.21	2.51	3.00	12.35	
	031001	I9MT1003B0125-NC2057			1.25		2.65	4.0	1.6	2.75	3.14			
	031002	I9MT1003B0150-NC2057			1.50		3.18	4.50	2.0	3.45	3.84			
	031003	I9MT1003B0160-NC2057			1.60		3.35	5.0	2.0	3.46	3.93			
	031004	I9MT1003B0200-NC2057			2.00		4.25	6.3	2.5	4.39	4.98			
	031005	I9MT1003B0250-NC2057			2.50		5.3	8.0	3.1	5.53	6.28			
	031006	I9MT1003B0300-NC2057			3.00		+0.18 0	6.46	9.00	4.1	7.10			7.83
	031007	I9MT1003B0315-NC2057			3.15		6.7	10.0	3.9	6.90	7.85			
12	033001	I9MT12T2B0200-NC2033	TiAlN	K20F	2.00	+0.14 0	4.25	6.3	2.5	4.39	4.98	2.54	11.73	
	033002	I9MT12T2B0250-NC2033			2.50	5.3	8.0	3.1	5.53	6.28	13.0			
	033003	I9MT12T2B0315-NC2033			3.15	6.7	10.0	3.9	6.90	7.85	14.0			
16	034001	I9MT1603B0400-NC2033	TiAlN	K20F	4.00	+0.18 0	8.5	12.5	5.0	8.9	10.03	3.18	19.4	
	034002	I9MT1603B0500-NC2033			5.00	10.6	16.0	6.3	11.15	12.68	19.4			
20	035001	I9MT2004B0630-NC2033	TiAlN	K20F	6.30	+0.22 0	13.2	18.0	8.0	13.98	15.33	4.76	28.4	
	035002	I9MT2004B0800-NC2033			8.00		17.0	*20	10.1	17.89	18.73		28.3	
25	036001	I9MT2506B1000-NC2033	TiAlN	K20F	10.00	+0.22 0	21.2	*25	12.8	22.5	23.57	6.35	34.2	

* Notice: The d3 size is different from DIN332 center hole.

The quantity of insert per box.:

IC 08	IC 10	IC 12	IC 16	IC 20	IC 25
5	5	5	2	1	1

DIN332 Form A & ANSI 60°

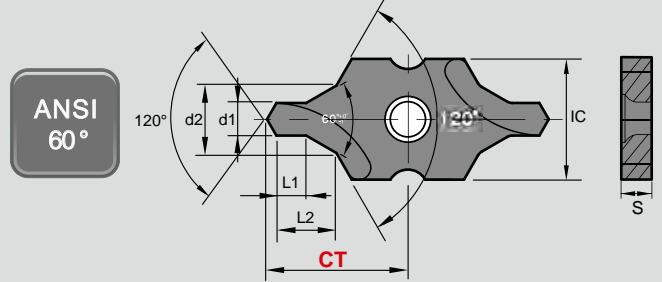
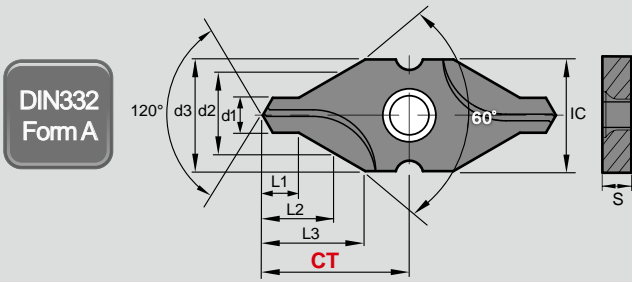

► For DIN332 Form A Center Hole >>

The quantity of insert per box.:

IC 08	IC 10	IC 12	IC 16	IC 20	IC 25
5	5	5	2	1	1

2

i-Center

IC	Code	Parts No.	Coating	Grade	d1	d2	d3	L1	L2	L3	S	CT ±0.025
08	032114	I9MT08T1A0200-NC5074	Helica	P40	2.0	4.25	8	2.15	4.10	7.35	2.00	10.5
		+0.03 0										
	032115	I9MT08T1A0250-NC5074			2.5	5.3	2.58	5.00	7.34			
	032116	I9MT08T1A0315-NC5074	3.15	6.7	3.23	6.30	7.43					



► For ANSI 60° Center Hole >>

IC	Code	Parts No.	Coating	Grade	Size	d1			d2		L1		L2	S	CT ±0.025
						mm			mm	mm	mm	mm			
12	033101	I9MT12T2A2-NC2033	TiAlN	K20F	#2	5/64	1.98	+0.14 0	3/16	4.76	5/64	1.98	4.4	2.54	12.6
	033102	I9MT12T2A3-NC2033			#3	7/64	2.78		1/4	6.35	7/64	2.78	5.9		13.8
	033103	I9MT12T2A4-NC2033			#4	1/8	3.18	5/16	7.94	1/8	3.18	7.3	14.25		
16	034101	I9MT1603A5-NC2033			#5	3/16	4.76	+0.18 0	7/16	11.11	3/16	4.76	10.3	3.18	20.0
	035101	I9MT2004A6-NC2033			#6	7/32	5.56		1/2	12.7	7/32	5.56	11.8	27.75	
20	035102	I9MT2004A7-NC2033			#7	1/4	6.35	+0.22 0	5/8	15.88	1/4	6.35	14.6	4.76	28.5
	035103	I9MT2004A8-NC2033	#8	5/16	7.94	3/4	19.05		5/16	7.94	17.6	29.0			
25	036101	I9MT2506A10-NC2033	#10	3/8	9.53	0.98"	25.0	3/8	9.53	22.9	6.35	34.9			

► Measuring Master >>

- Apply on lathe to align the center of work spindle and tool.
- Each insert has just one measuring tip.
- Concentricity: ±0.01mm

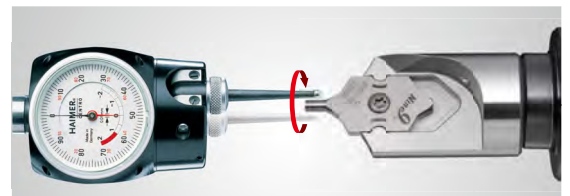

IC08	IC10	IC12	IC16	IC20
I9MT08T1-MM	I9MT1003-MM	I9MT12T2-MM	I9MT1603-MM	I9MT2004-MM

Holders of Indexable Center Drill



▶ Holder >>

- Made of hardened high alloy steel, 53 HRC.
- IC08 shank is cylindrical shank.
Other shanks are weldon shank.

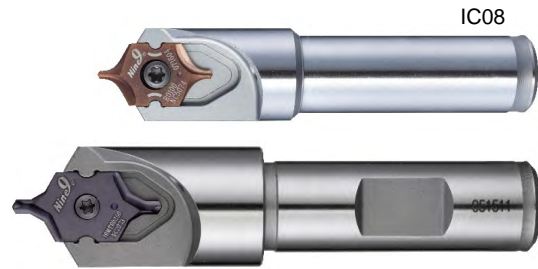
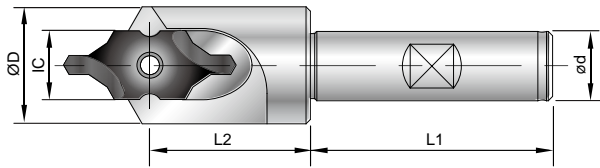

IC	Code	Parts No.	Type	ød	L1	L2	ØD	Screw	Key
08	802002	00-99616-IC08-10F	BC10-IC08F	10	30	18.5	12	*NS-25060 0.9 Nm	NK-T7
	812002	00-99616-IC08-3/8F	BC3/8"-IC08F	3/8"					
10	801002	00-99616-IC10-12F	SB12-IC10F	12	45	24.5	16	*NS-25060 0.9 Nm	NK-T7
12	803002	00-99616-IC12-16F	SB16-IC12F	16	48	30.5	21	NS-30072 2.0 Nm	NK-T9
	813002	00-99616-IC12-5/8F	SB5/8"-IC12F	5/8"					
16	804002	00-99616-IC16-16F	SB16-IC16F	16	48	37	27	NS-35080 2.5 Nm	NK-T15
	814002	00-99616-IC16-5/8F	SB5/8"-IC16F	5/8"					
20	805002	00-99616-IC20-20F	SB20-IC20F	20	50	51	32	NS-50125 5.5 Nm	NK-T20
	815002	00-99616-IC20-3/4F	SB3/4"-IC20F	3/4"					
25	806002	00-99616-IC25-25F	SB25-IC25F	25	56	56	43	NS-50125 5.5 Nm	NK-T20
	816002	00-99616-IC25-1F	SB 1"-IC25F	1"					

*Torque screwdriver is recommended.

▶ Cylindrical Shank with Pre-balanced >>

- Pre-balanced holder enhance the stability of centering to get high accurate profile.
- G6.3 / 10,000 r.p.m.

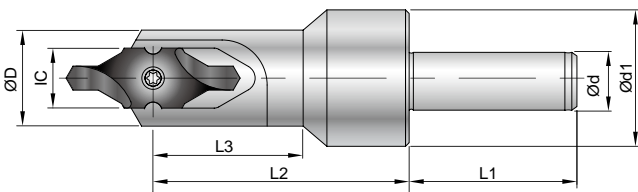

IC	Code	Parts No.	Type	ød	ød1	L1	L2	L3	ØD	Screw	Key
08	802003	00-99616-IC08-10B	BC10-IC08B	10	22	30	33.5	19	12	*NS-25060 0.9 Nm	NK-T7
12	803003	00-99616-IC12-12B	BC12-IC12B	12	34	48	51	30	21	NS-30072 2.0 Nm	NK-T9
16	804003	00-99616-IC16-16B	BC16-IC16B	16	39	48	67	37	27	NS-35080 2.5 Nm	NK-T15
20	805003	00-99616-IC20-20B	BC20-IC20B	20	49	50	86	51	32	NS-50125 5.5 Nm	NK-T20
25	806003	00-99616-IC25-25B	BC25-IC25B	25	59	56	99	56	43	NS-50125 5.5 Nm	NK-T20

*Torque screwdriver is recommended.

Holders of Indexable Center Drill

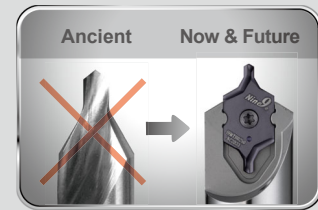

▶ Square Shank 25 x 25 Right / Left Hand >>

- For used on lathe, clamp by VDI and BMT holders.
- Made of hardened alloy steel, 40 HRC.
- Other sizes are available on request.

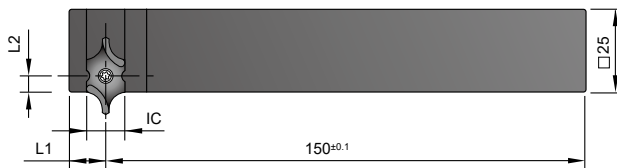

IC	Code	Parts No.	L1	L2	Screw	Key
08	822022	00-99616-IC08-R2525MF	8	3.25	*NS-25060 0.9 Nm	NK-T7
	822012	00-99616-IC08-L2525MF				
12	823022	00-99616-IC12-R2525MF	11	4.9	NS-30072 2.0 Nm	NK-T9
	823012	00-99616-IC12-L2525MF				
16	824022	00-99616-IC16-R2525MF	13	4.9	NS-35080 2.5 Nm	NK-T15
	824012	00-99616-IC16-L2525MF				

*Torque screwdriver is recommended.

▶ Double Flat Shank >> Non-Stock Item

- Used on lathe.
- Double flat shank design for tool holder with side lock flat.
- 180° for insert at top, 90° for insert at front.

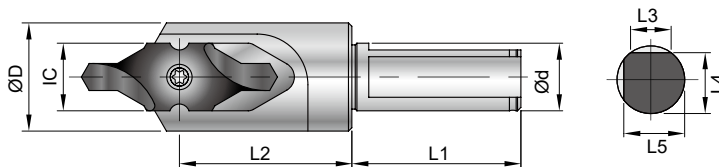

IC	Code	Parts No.	Type	Ød	L1	L2	L3	L4	L5	ØD	Screw	Key
08	802004	00-99616-IC08-10S	SL10-IC08S	10	30	18.5	6	9	9	12	*NS-25060 0.9 Nm	NK-T7
12	803004	00-99616-IC12-16S	SL16-IC12S	16	48	30.5	9.33	14.5	14.5	21	NS-30072 2.0 Nm	NK-T9
16	804004	00-99616-IC16-16S	SL16-IC16S	16	48	37	9.33	14.5	14.5	27	NS-35080 2.5 Nm	NK-T15
20	805004	00-99616-IC20-20S	SL20-IC20S	20	50	51	12	18	18	32	NS-50125 5.5 Nm	NK-T20
25	806004	00-99616-IC25-25S	SL25-IC25S	25	56	56	13.57	23	23	43	NS-50125 5.5 Nm	NK-T20

*Torque screwdriver is recommended.

Center Height Adjusting Sleeve

► Principle >>

- Designed for adjusting Center Height of center drills, NC spot drills, reamers and taps on the CNC lathes.
- The main body is made from two sleeves. The inner sleeve is to hold and lock the cutting tool.
- Its center is inclined to the outer sleeve. When the inner sleeve is pushed or pulled, the cutting tool's center height is adjusted to lower or higher position.

► Parts No.:00-99600-320H >>

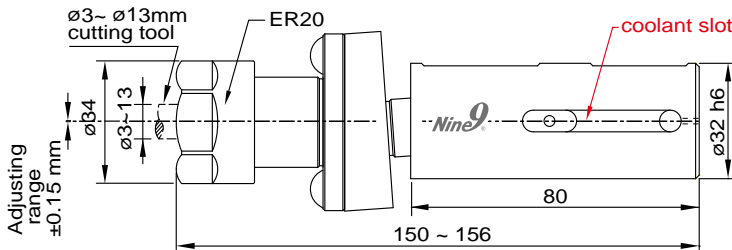

► Type : SB32-IDER20

► Parts No.:00-99600-400H >>

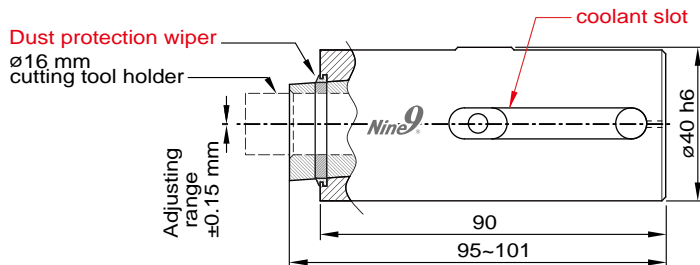

► Type : SB40-ID16

► Applications >>

- Used when the CNC lathes need to adjust the center height.
- This sleeve can be clamped by VDI 40, VDI 50 E2 tool holders, and other types internal turning tool holders.
- Center height adjusting range: ± 0.15 mm (.006").
- Total axial movement is 6mm (.236").

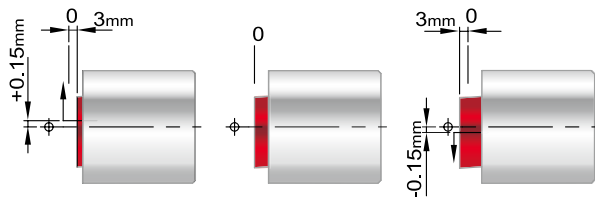

Tightening screw 4mm Hex key

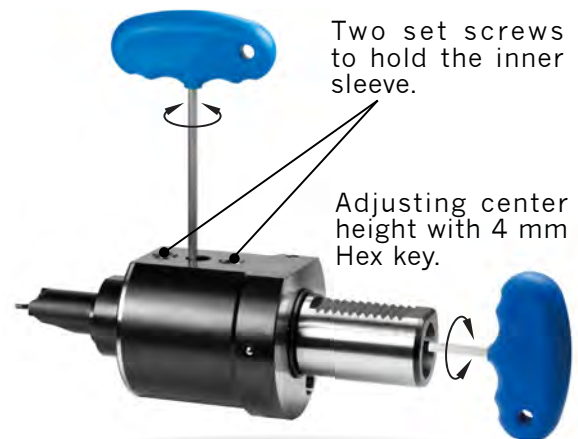

Performance

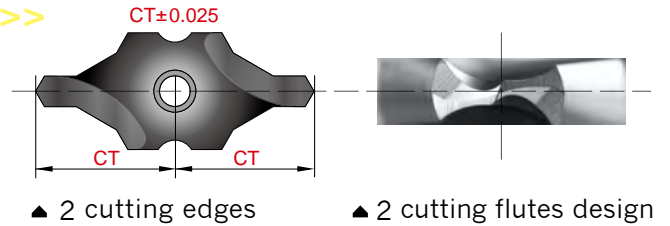

► Profit by making the right choice >>

- High speed and feed rate reduce cutting time.
- The unique design increases tool life and reduces change over time.



► Comparison >>

- Workpiece : Low carbon alloy steel, 850 N/mm²
- Machine: VMC BT40 with internal coolant

Diameter of tool : Ø3.15 mm Depth of drilling : 7.2 mm				
Comparison		i-Center	HSS Center Drill (TiN Coating)	Solid Carbide Center Drill
Cutting speed	m/min.	65	17	65
Spindle speed	r.p.m.	6570	1718	6570
Feed rate f =	mm/rev.	0.12	0.02	0.1
Feed rate F=	mm/min.	788.4	34.4	657
Coolant	Emulsion	External / Internal	External	External
Drilling time	sec.	0.55	12.5	0.65
Holes of drilling per edge		7000	700	5000

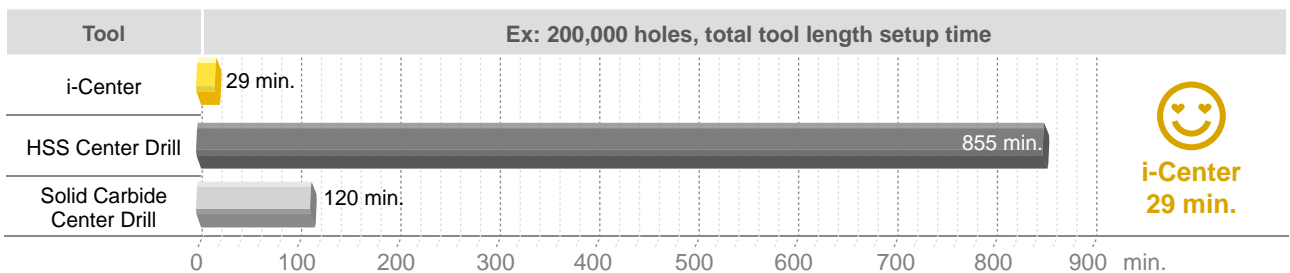
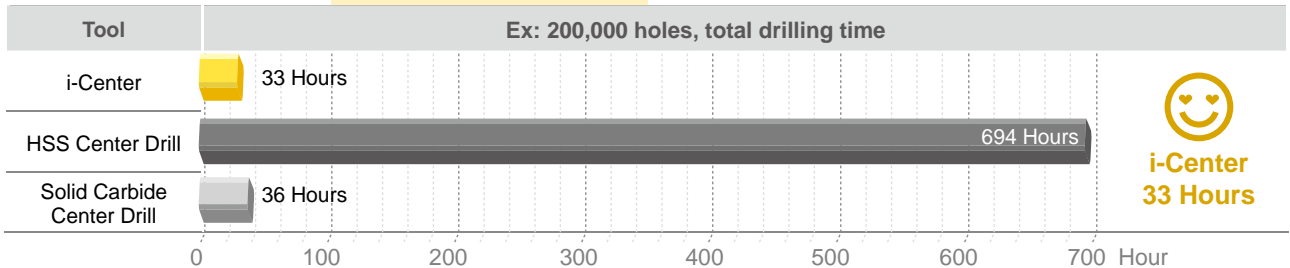

► Surface finish >>

i-Center Insert	Material SCM440		
I9MT1603B0500 NC2033	Vc	60 m/min.	
	S	3800 r.p.m.	
	f	0.1 mm/rev.	
	F	380 mm/min.	
	Ap	13.5 mm	

```

Perthometer M1
Object
Name
#
Lt 5.600 mm
Ls Standard 2.5 µm
Lc 0.800 µm
Ra 0.562 µm
Rz 3.26 µm
Rmax 3.61 µm
RPa(0.5,-0.5) 68 /c

R Profile
Lc 0.800 mm
VER 2.50 µm
    
```



i-Center Enquiry Form

► Previous process tool >>

► Challenge or improvement >>

The following information should be checked while discussing with customer.

Machine	
Machine Type	
Spindle Speed	Max. r.p.m.
Power of Spindle motor	<input type="checkbox"/> KW <input type="checkbox"/> HP
Coolant supply	<input type="checkbox"/> NO <input type="checkbox"/> If yes, <input type="checkbox"/> External <input type="checkbox"/> Internal bar(psi)
Current tool	
Cutting Speed	<input type="checkbox"/> HSS <input type="checkbox"/> Solid Carbide m/min. SFM
Others	
Feed Rate	mm/rev. inch/rev.
Work Piece	
Material code	
Center hole type	<input type="checkbox"/> R <input type="checkbox"/> A <input type="checkbox"/> B <input type="checkbox"/> C <input type="checkbox"/> Other as attached drawing
Other request	<input type="checkbox"/> Surface roughness <input type="checkbox"/> Tolerance(see below)

► Special Tool holder shank dimensions >>

- Special tool holder shank, please fill in D1 and L4.
 As attached workpiece drawing.
 Metric Inch Right Left

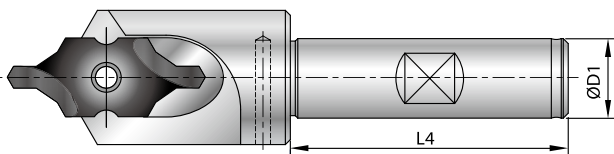

► Center hole dimension >>

- Please provide workpiece drawing
- One of following type should be chosen.

Type R

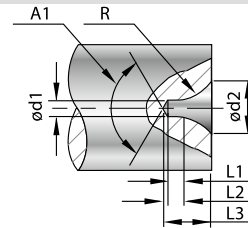

Type A

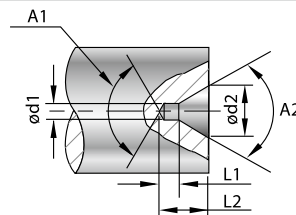

Type B

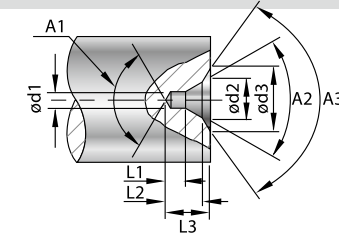

Type C

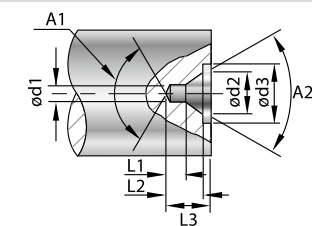

Other

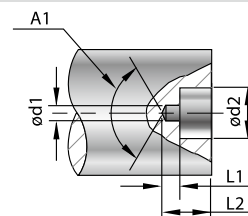

Dimension Table	A1	A2	A3	ød1	ød2	ød3
Dimension						
Tolerance	---	+0° -1°	±1°	±0.05	±0.05	---

Dimension Table	L1	L2	L3	R	øD1	L4
Dimension						
Tolerance	±0.05	±0.05	±0.05	±0.5	h6	---

Technical Standard ISO 2541-1972 / DIN332

► 60° Center holes >>

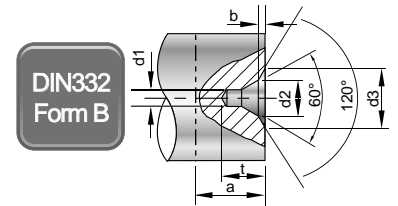
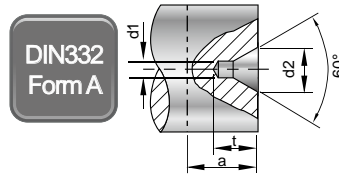
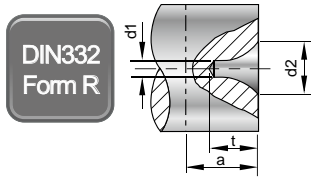

STD	DIN332 Form R ISO 2541-1972			DIN332 Form A ISO 866-1975			DIN332 Form B ISO 2540 1973					
	d1	d2	t	a	d2	t	a	d2	b	d3	t	a
1	2.12	1.9	3	3	2.12	1.9	3	2.12	0.3	3.15	2.2	3.5
1.25	2.65	2.3	4	4	2.65	2.3	4	2.65	0.4	4	2.7	4.5
1.6	3.35	2.9	5	5	3.35	2.9	5	3.35	0.5	5	3.4	5.5
2	4.25	3.7	6	6	4.25	3.7	6	4.25	0.6	6.3	4.3	6.6
2.5	5.3	4.6	7	7	5.3	4.6	7	5.3	0.8	8	5.4	8.3
3.15	6.7	5.8	9	9	6.7	5.9	9	6.7	0.9	10	6.8	10
4	8.5	7.4	11	11	8.5	7.4	11	8.5	1.2	12.5	8.6	12.7
5	10.6	9.2	14	14	10.6	9.2	14	10.6	1.6	16	10.8	15.6
6.3	13.2	11.4	18	18	13.2	11.5	18	13.2	1.4	18	12.9	20
8	17	14.7	22	22	17	14.8	22	17	1.6	22.4	16.4	25
10	21.2	18.3	28	28	21.2	18.4	28	21.2	2	28	20.4	31

* a: Minimum material will be cut. If the center hole will be removed after turning or grinding. (mm/inch)

► Form R center hole apply for >>

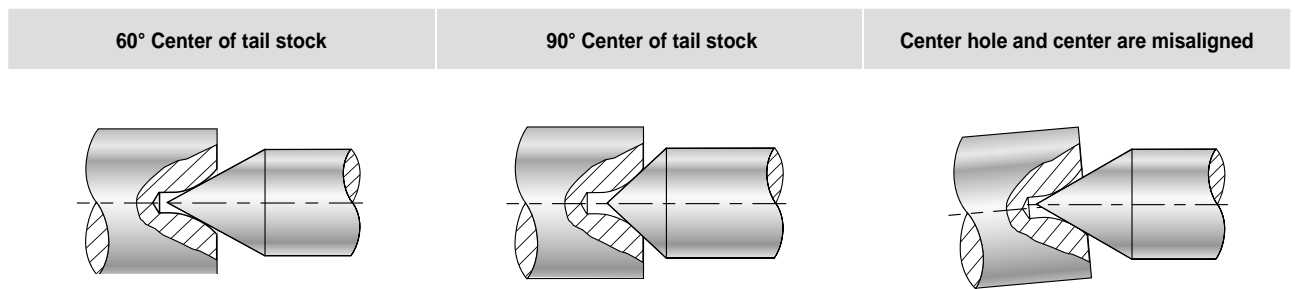

► Form B center hole apply for >>

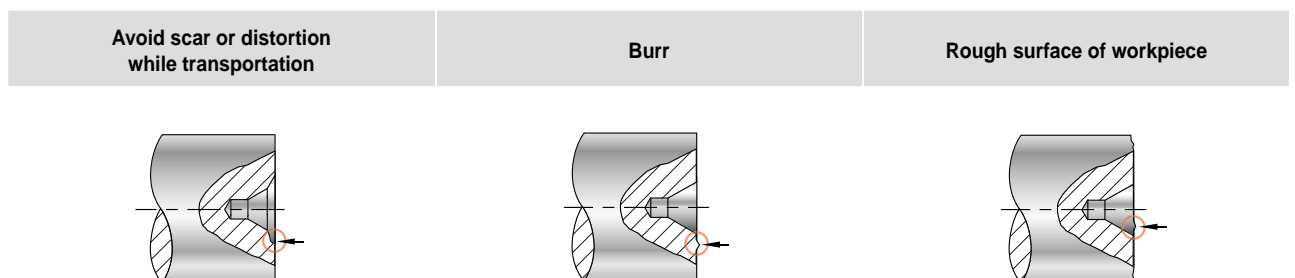

i-Center Applications

► Tip >>

- Various centering applications and products - shafts of engine, transmission gear, bearings, motors, grinding parts, spindles, gear reducers, cooling fan, universal joints...
- Special forms for other applications also available on request.

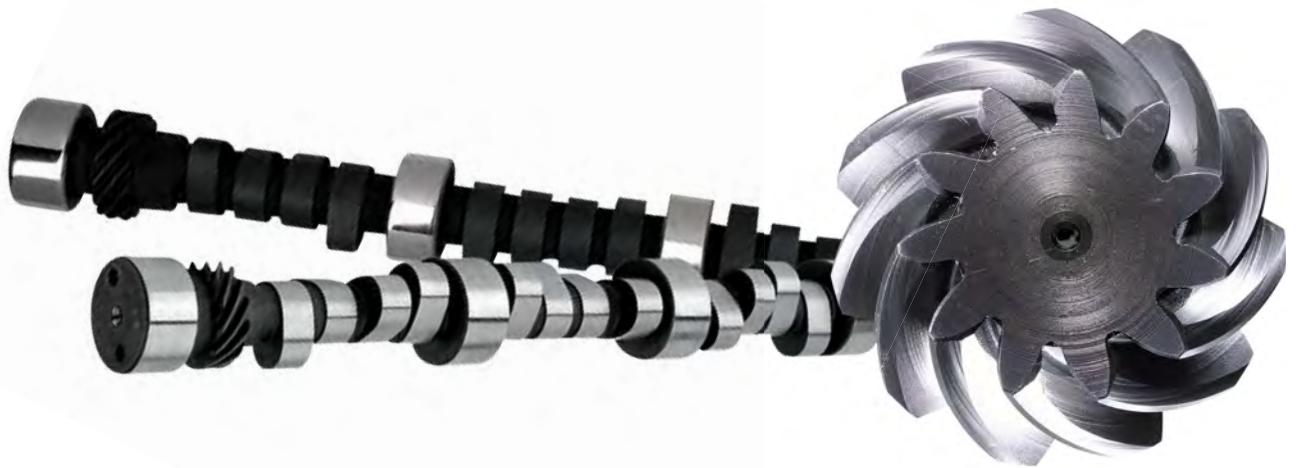





2

i-Center

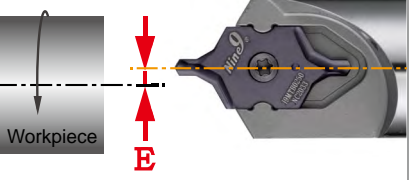

Technical Guide

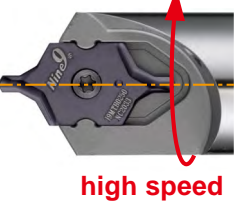
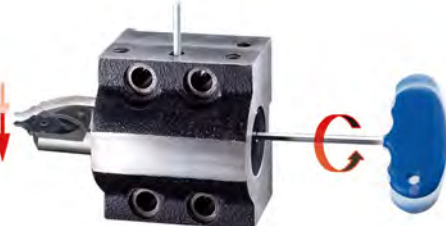
► Before you start, please pay attention the following conditions >>

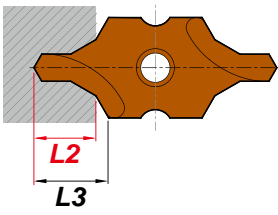
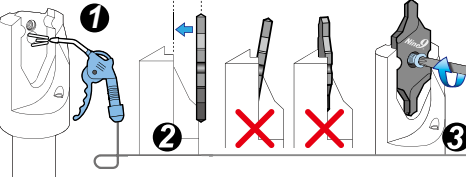
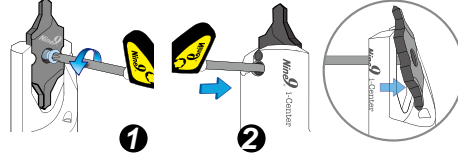
<p>Center misalignment</p> <p>E must be < 0.02mm.</p> 	<p>Driving Tool</p> <p>low speed : high speed 1 : 3</p> <p>low speed</p>  <p>high speed</p> 	<p>Center height adjusting sleeve</p> <p>When CNC lathe turret center is misaligned ≥ 0.15mm, please use center height adjusting sleeve. (See page 2-55)</p> 
<p>Internal coolant</p> <p>Internal coolant is recommended.</p> 	<p>DIN 332 Form A+B</p> <p>Reduce 30% of Spindle speed and keep same feed rate (mm/rev.) while depth L2 is reached.</p> 	<p>Clamping insert</p>  <p>Loosen insert</p> 



Metric		Inch	
	d1 = diameter -mm		d1 = diameter-inch
	S = Spindle Speed -r.p.m.		S = Spindle Speed-r.p.m.
$S = \frac{Vc \times 1000}{\pi \times d1}$	Vc = Cutting Speed -m/min.	$S = \frac{(3.82 \times SFM)}{d1}$	SFM = Surface Speed-ft./min. Vc (m/min.) x 3.28
F = S x f	f = mm/rev.	F = IPR x r.p.m	f = IPR = inch/rev.
	F = mm/min.		F = inch/min.

2

i-Center



Cutting Data

▶ Ø1~Ø3.15 (#2~#4)

Workpiece material	Vc (m/min.)	d1 (pilot dia.)	IC08 / IC10		IC12				
			Ø1~1.25	Ø1.6~3.15	Ø2 (#2)	Ø2.5 (#3)	Ø3.15 (#4)		
P Carbon steel C<0.3%	< 80	S r.p.m.	2000 ~ 10000	1600 ~ 8000	1600 ~ 8000	1400 ~ 7000	1200 ~ 6000	●	○
		f mm/rev.	0.02~0.03~0.05	0.03~0.05~0.06	0.04~0.06~0.08	0.06~0.08~0.10	0.08~0.10~0.12	●	○
	< 70	S r.p.m.	2000 ~ 9000	1600~ 7200	1600 ~ 7200	1400 ~ 6300	1200 ~ 5400	●	○
		f mm/rev.	0.02~0.03~0.05	0.03~0.04~0.05	0.03~0.04~0.05	0.06~0.08~0.10	0.08~0.10~0.12	●	○
Low alloy steel C<0.3%	< 65	S r.p.m.	2000 ~ 8000	1600 ~ 6400	1600 ~ 6400	1400 ~ 5600	1200 ~ 4800	●	○
		f mm/rev.	0.01~0.02~0.04	0.02~0.03~0.05	0.02~0.03~0.05	0.04~0.06~0.08	0.06~0.08~0.10	●	○
High alloy steel C>0.3%	< 60	S r.p.m.	1000 ~ 6000	800 ~ 4800	800 ~ 4800	700 ~ 4200	600 ~ 3600	●	○
		f mm/rev.	0.01 ~ 0.02	0.01~0.02~0.04	0.01~0.02~0.04	0.02~0.04~0.06	0.04~0.06~0.08	●	○
M Stainless steel	< 20	S r.p.m.	1000 ~ 3000	800 ~ 2400	800 ~ 2400	700 ~ 2100	600 ~ 1800	●	○
		f mm/rev.	0.003 ~ 0.01	0.005 ~ 0.02	0.01 ~ 0.02	0.01~0.02~0.03	0.02~0.03~0.05	≥ 5 bar	○
K Casting iron	< 70	S r.p.m.	2000 ~ 9000	1600 ~ 7200	1600 ~ 7200	1400 ~ 6300	1200 ~ 5400		Air
		f mm/rev.	0.01~0.02~0.04	0.02~0.04~0.06	0.02~0.04~0.06	0.04~0.06~0.08	0.06~0.08~0.10		
N Al, and non-ferrous metal	< 200	S r.p.m.	6000 ~ 20000	4800 ~ 16000	4800 ~ 16000	4200 ~ 14000	3600 ~ 12000	●	○
		f mm/rev.	0.01~0.02~0.03	0.01~0.02~0.04	0.01~0.02~0.04	0.02~0.03~0.05	0.02~0.04~0.06	●	○

● Best ○ Possible

▶ Ø4~Ø10 (#5~#10)

Workpiece material	Vc m/min.	d1 (pilot dia.)	IC16			IC20		IC25		
			Ø4 (#5)	Ø5	(#6)	Ø6.3 (#7)	Ø8 (#8)	Ø10 (#10)		
P Carbon steel C<0.3%	< 80	S r.p.m.	1000 ~ 5000	900 ~ 4500	800 ~ 4000	700 ~ 3500	600 ~ 3000	●	○	
		f mm/rev.	0.08~0.12~0.14	0.10~0.12~0.16	0.10~0.14~0.16	0.12~0.15~0.18	0.14~0.18~0.20	●	○	
	< 70	S r.p.m.	1000 ~ 4500	900 ~ 4050	800 ~ 3600	700 ~ 3150	600 ~ 2700	●	○	
		f mm/rev.	0.08~0.12~0.14	0.10~0.12~0.16	0.10~0.14~0.16	0.12~0.15~0.18	0.14~0.18~0.20	●	○	
Low alloy steel C<0.3%	< 65	S r.p.m.	1000 ~ 4000	900 ~ 3600	800 ~ 3200	700 ~ 2800	600 ~ 2400	●	○	
		f mm/rev.	0.06~0.08~0.10	0.08~0.10~0.12	0.08~0.12~0.14	0.10~0.14~0.16	0.12~0.16~0.20	●	○	
High alloy steel C>0.3%	< 60	S r.p.m.	500 ~ 3000	450 ~ 2700	400 ~ 2400	350 ~ 2100	300 ~ 1800	●	○	
		f mm/rev.	0.04~0.06~0.08	0.06~0.08~0.10	0.08~0.10~0.12	0.10~0.14~0.16	0.10~0.14~0.16	●	○	
M Stainless Steel	< 25	S r.p.m.	500 ~ 1500	450 ~ 1350	400 ~ 1200	350 ~ 1050	300 ~ 900	●	○	
		f mm/rev.	0.02~0.04~0.06	0.02~0.04~0.06	0.04~0.06~0.08	0.04~0.06~0.08	0.05~0.07~0.10	≥ 5 bar	○	
K Casting iron	< 70	S r.p.m.	1000 ~ 4500	900 ~ 4050	800 ~ 3600	700 ~ 3150	600 ~ 2700		Air	
		f mm/rev.	0.06~0.08~0.10	0.08~0.10~0.12	0.08~0.12~0.14	0.10~0.14~0.16	0.12~0.16~0.18			
N Al, and non-ferrous metal	< 200	S r.p.m.	3000 ~ 10000	2700 ~ 9000	2400 ~ 8000	2100 ~ 7000	1800 ~ 6000	●	○	
		f mm/rev.	0.02~0.04~0.06	0.04~0.06~0.08	0.04~0.06~0.08	0.06~0.08~0.10	0.06~0.08~0.10	●	○	

● Best ○ Possible

2

i-Center



Engraving Tool >>>

30° / 45° / 60° / 90°

This is a revolutionary new concept of engraving tools with indexable carbide insert. Provide HIGH QUALITY ENGRAVING in most kinds of material. Higher speed and feed rate, dramatically reducing your cycle time.



► **No Need To Reset After Changing Insert Or Cutting Edge**

- 2 Cutting Edges.
- Excellent repeatability!



Features >>>

► **High Positive Rake Angle**

- Very sharp edge for shallow engraving.
- Suitable for all types of materials, such as plastic, non-ferrous metal, aluminum, copper, carbon steel and stainless steel.

► **Multi-Side Grinding**

- Full peripherally ground insert to ensure efficient repeatability.
- It performs excellently without producing any burrs, especially in copper, aluminum and stainless steel.

► **High Speed, High Feed Rate**

- Designed to run at high speed, up to 40,000 r.p.m.
- Feed rate 0.08mm (0.003") / rev. apply to aluminum; 0.05mm (0.002") / rev. apply to stainless steel.
- Reduces engraving cycle time!

► **Special forms are available on request**





Applications

- Serial numbers, product codes, dial scales, signs, logo, graph and almost any character which can be created by the NC programming system.

Ultrasonic welding drum



Mold & Die

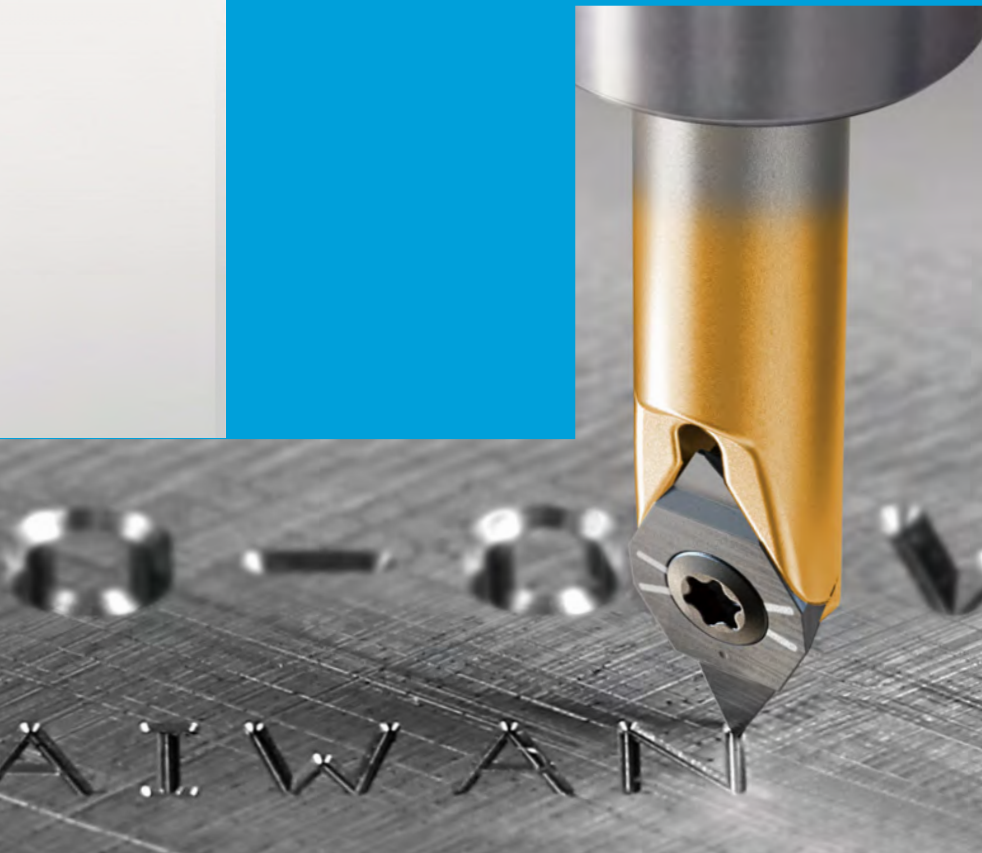

“ Widely be used for marking on machine components, medical components, gun components, mold and die, automotive parts, gears, bearings and luxury goods. ”

Dial scales

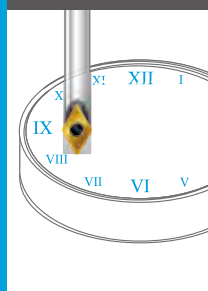

Product info

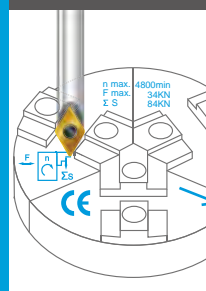







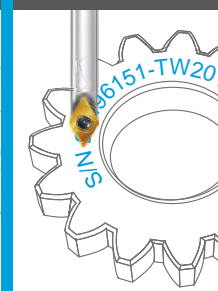



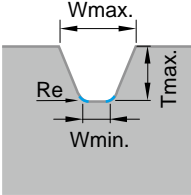





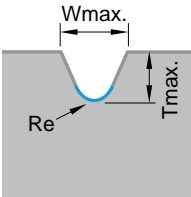

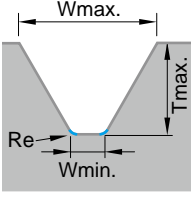

Logo outlines

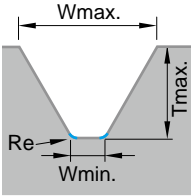

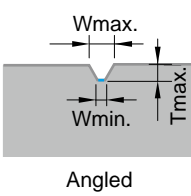
Serial number

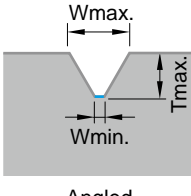

Engraving Tool System

Type	Form	Angle	Insert	Wmin.	Wmax.	Tmax.	Holder		
X060 Series	 <p>Radius Angled</p>	30°	 X060A30W...	0.2	0.52	0.6	 99619-X060... Ø6, Ø8		
		45°	 X060A45W...		0.86	0.8			
		60°	 X060A60W...		1.36	1.0			
		90°	 X060A90W...		2.2	1.0			
	 <p>Radius</p>	30°	 X060A30R...	Re: 0.2	0.63	0.6			
		45°	 X060A45R...		0.93	0.8			
60°		 X060A60R...	1.39		1.0				
V045 V060 Series	 <p>Radius Angled</p>	45°	 V04506T1W	0.45	2.1	2.0	 V04506T1W Ø6, Ø8		
				0.65					
	 <p>Radius Angled / Angled</p>	60°	 V06006T1W	0.25	1.1	0.8			
				0.45				2.7	2.0
				0.65	2.7	2.0			
W060 Series	 <p>Angled</p>	60°	 W06004S	0.1	0.33	0.2	 99619-W060... Ø4		
				0.2				0.66	0.4
				0.3				0.99	0.6
N9MT-W Series	 <p>Angled</p>	60°	 N9MT080201W -60-NC40	0.2	1.1	0.8	 99616-10...SW Ø10, Ø3/8"		
		90°	 N9MT080201W	0.2				2.0	0.9

3

Engraving Tool

X060 Engraving Tool 30°

30°



▶ Inserts >>

NC2032: • For all kinds of steel from < 40 HRC, carbon steel, alloy steel, and cast iron.

NC2035: • ALDURA coating, reduces heat and tool wear.
• For steel with heat treatment up to 56 HRC.

XP9001: • For non-ferrous metal, aluminum, brass, copper, plastic, acrylic.

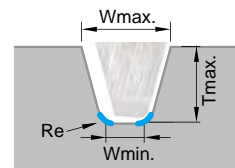

• Radius Angled Form

Angle	Code	Parts No.	Coating	Grade	Re	Dimensions			Wmin.	Wmax.	Tmax.
						L	S	Re			
30°	01X0140	X060A30W020R	NC2032	TiAlN	K20F	6	2.05	0.04	0.20	0.52	0.6
	01X0141		NC2035	ALDURA							
	01X0142		XP9001	Uncoated							

• Radius Form

Angle	Code	Parts No.	Coating	Grade	Re	Dimensions			R max. Depth	Wmax.	Tmax.
						L	S	Re			
30°	01X0119	X060A30R020	NC2032	TiAlN	K20F	6	2.05	0.2	0.15	0.63	0.6
	01X0132		NC2035	ALDURA							
	01X0134		XP9001	Uncoated							

▶ Holder >>

• One holder supports the entire X060 series of carbide inserts.

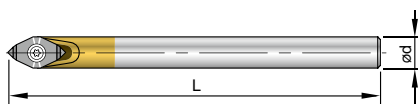

Code	Parts No.	Shank	Ød	L	Screw	Key
69X001	00-99619-X060-06	Steel	6	40	*NS-22044 0.9Nm	NK-T7
69X002	00-99619-X060-06L	Carbide	6	60		
69X003	00-99619-X060-06LS	Steel	6	60		
69X004	00-99619-X060-06XL	Carbide	6	100		
69X005	00-99619-X060-08	Steel	8	60		

*Torque screwdriver is recommended.

3

Engraving Tool

45° X060 Engraving Tool 45°



▶ Inserts >>

- NC2032:** • For all kinds of steel from < 40 HRC, carbon steel, alloy steel, and cast iron.
- NC2035:** • ALDURA coating, reduces heat and tool wear.
• For steel with heat treatment up to 56 HRC.
- XP9001:** • For non-ferrous metal, aluminum, brass, copper, plastic, acrylic.

• Radius Angled Form

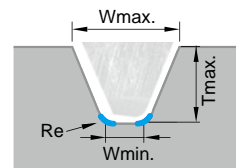

Angle	Code	Parts No.	Coating	Grade	Diagram	Dimensions			Wmin.	Wmax.	Tmax.	
						L	S	Re				
45°	01X0021	NC2032	TiAlN	K20F		6	2.05	0.04	0.20	0.86	0.8	
	01X0153	X060A45W020R	NC2035									ALDURA
	01X0154	XP9001	Uncoated									

• Radius Form

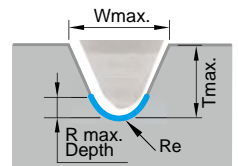

Angle	Code	Parts No.	Coating	Grade	Diagram	Dimensions			R max. Depth	Wmax.	Tmax.	
						L	S	Re				
45°	01X0013	NC2032	TiAlN	K20F		6	2.05	0.2	0.12	0.93	0.8	
	01X0149	X060A45R020	NC2035									ALDURA
	01X0150	XP9001	Uncoated									

▶ Holder >>

- One holder supports the entire X060 series of carbide inserts.

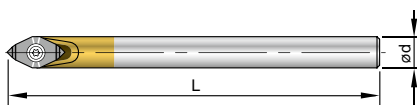

Code	Parts No.	Shank	Ød	L	Screw	Key
69X001	00-99619-X060-06	Steel	6	40	*NS-22044 0.9Nm	NK-T7
69X002	00-99619-X060-06L	Carbide	6	60		
69X003	00-99619-X060-06LS	Steel	6			
69X004	00-99619-X060-06XL	Carbide	6			
69X005	00-99619-X060-08	Steel	8	60		

*Torque screwdriver is recommended.

X060 Engraving Tool 60°

60°



► Inserts >>

NC2032: • For all kinds of steel from < 40 HRC, carbon steel, alloy steel, and cast iron.

NC2035: • ALDURA coating, reduces heat and tool wear.
• For steel with heat treatment up to 56 HRC.

XP9001: • For non-ferrous metal, aluminum, brass, copper, plastic, acrylic.

• Radius Angled Form

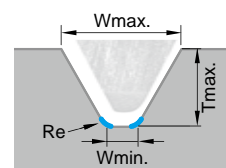

Angle	Code	Parts No.	Coating	Grade	Re	Dimensions			Wmin.	Wmax.	Tmax.	
						L	S	Re				
60°	01X0063	NC2032	TiAIN	K20F		6	2.05	0.04	0.20	1.36	1.0	
	01X0165	X060A60W020R	NC2035									ALDURA
	01X0166	XP9001	Uncoated									

• Radius Form

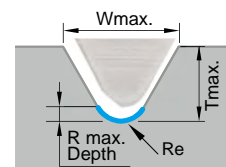

Angle	Code	Parts No.	Coating	Grade	Re	Dimensions			R max. Depth	Wmax.	Tmax.	
						L	S	Re				
60°	01X0117	NC2032	TiAIN	K20F		6	2.05	0.2	0.10	1.39	1.0	
	01X0158	X060A60R020	NC2035									ALDURA
	01X0159	XP9001	Uncoated									

► Holder >>

• One holder supports the entire X060 series of carbide inserts.

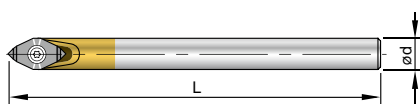

Code	Parts No.	Shank	Ød	L	Screw	Key
69X001	00-99619-X060-06	Steel	6	40	*NS-22044 0.9Nm	NK-T7
69X002	00-99619-X060-06L	Carbide	6	60		
69X003	00-99619-X060-06LS	Steel	6	60		
69X004	00-99619-X060-06XL	Carbide	6	100		
69X005	00-99619-X060-08	Steel	8	60		

*Torque screwdriver is recommended.

90° X060 Engraving Tool 90°



► Inserts >>

- NC2032:** • For all kinds of steel from < 40 HRC, carbon steel, alloy steel, and cast iron.
- NC2035:** • ALDURA coating, reduces heat and tool wear.
• For steel with heat treatment up to 56 HRC.
- XP9001:** • For non-ferrous metal, aluminum, brass, copper, plastic, acrylic.

• Radius Angled Form

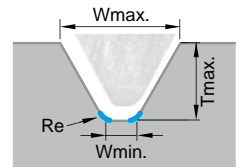

Angle	Code	Parts No.	Coating	Grade	Re	Dimensions			Wmin.	Wmax.	Tmax.	
						L	S	Re				
90°	01X0207	NC2032	TiAlN	K20F		6	2.05	0.04	0.2	2.2	1.0	
	01X0208	X060A90W020R	NC2035									ALDURA
	01X0209	XP9001	Uncoated									

► Holder >>

- One holder supports the entire X060 series of carbide inserts.

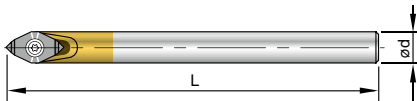

Code	Parts No.	Shank	Ød	L	Screw	Key
69X001	00-99619-X060-06	Steel	6	40	*NS-22044 0.9Nm	NK-T7
69X002	00-99619-X060-06L	Carbide	6	60		
69X003	00-99619-X060-06LS	Steel	6	60		
69X004	00-99619-X060-06XL	Carbide	6	100		
69X005	00-99619-X060-08	Steel	8	60		

*Torque screwdriver is recommended.

V045 Engraving Tool 45°

45°



▶ Inserts >>

- NC2071:**
- Strong edge on chip-breaker, best suited for min. DOC 0.2mm.
 - Universal grade for all kinds of steel <30 HRC, non-ferrous metal and stainless steel.
- NC2032:**
- Long tool life.
 - For all kinds of steel from 30~50 HRC, carbon steel, alloy steel, and cast iron.
- NC9031:**
- Fully positive ground rake angle, very sharp edge for shallow engraving.
 - For non-ferrous metal such as aluminum, brass, copper, titanium, plastic and acrylic.

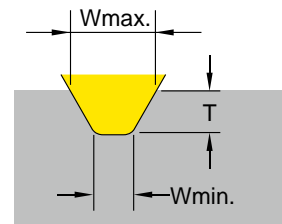

Angle	Code	Parts No.	Coating	Grade	Re	Dimensions			W		T	
						L	S	Re	Wmin.	Wmax.	Tmin.	Tmax.
45°	0104501	NC2071	TiN	K20F		6.35	2.0	0.2	0.65	2.1	0.20	2.0
	0104502	V04506T1W06	TiAlN						0.65		0.20	
	0104504	NC9031	TiN						0.45		0.05	

▶ Holder >>

- Carbide shank holders for high speed cutting.
- XL (100mm length) is only for Al, Al-alloy cutting, unbalanced <0.6gm.

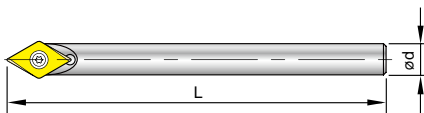

Angle	Code	Parts No.	Shank	Ød	L	Screw	Key
45°	691001	00-99619-V045-06	Steel	6	40	*NS-22044 0.9Nm	NK-T7
	691002	00-99619-V045-06L	Carbide		60		
	691003	00-99619-V045-06XL	Carbide		100		
	691004	00-99619-V045-08	Steel	8	60		

*Torque screwdriver is recommended.

▶ Starter Kit >> V045 & V060

Angle	Code	Parts No.	Shank Ø	Insert included	Content
45°	691201-4501	00-99619-V045-03K-71	99619-V045-06	V04506T1W06-NC2071	1 x Holder 1 x T7 Key 3 x inserts
	691201-4502	00-99619-V045-03K-32		V04506T1W06-NC2032	
	691201-4504	00-99619-V045-03K-31		V04506T1W06-NC9031	
60°	692201-6001	00-99619-V060-03K-71	99619-V060-06	V06006T1W06-NC2071	
	692201-6002	00-99619-V060-03K-32		V06006T1W06-NC2032	
	692201-6003	00-99619-V060-03K-35		V06006T1W06-NC2035	
	692201-6004	00-99619-V060-03K-31		V06006T1W06-NC9031	

60° V060 Engraving Tool 60°

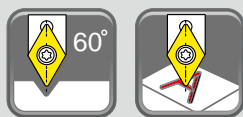

► Inserts >>

- NC2071:**
 - Strong edge on chip-breaker, best suited for min. DOC 0.2mm.
 - Universal grade for all kinds of steel <30HRC, non-ferrous metal and stainless steel.
- NC2032:**
 - Long tool life.
 - For all kinds of steel from 30~50 HRC, carbon steel, alloy steel, and cast iron.
- NC2035:**
 - ALDURA coating, reduces heat and tool wear.
 - For steel with heat treatment up to 56 HRC.
- NC9031:**
 - Fully positive ground rake angle very sharp edge for shallow engraving.
 - For non-ferrous metals such as aluminum, brass, copper, titanium, plastic and acrylic.
- NC9036:**
 - DLC coating, very sharp edge produces excellent surface finish.
 - For non ferrous metals such as aluminum, brass, copper, titanium, plastic and acrylic.

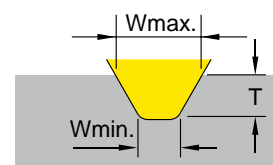

Angle	Code	Parts No.	Coating	Grade		Dimensions			W		T	
						L	S	Re	Wmin.	Wmax.	Tmin.	Tmax.
60°	0106001	NC2071	TiN	K20F		6.35	2.0	0.2	0.65	2.7	0.20	2.0
	0106002	NC2032	TiAlN						0.65		0.20	
	0106003	NC2035	ALDURA						0.65		0.20	
	0106004	NC9031	TiN						0.45		0.05	
Angle	Code	Parts No.	Coating	Grade		Dimensions			W		T	
						L	S	Re	Wmin.	Wmax.	Tmin.	Tmax.
60°	0106006	NC2032	TiAlN	K20F		6.35	2.0	---	0.25	1.1	0.05	0.8
	0106007	NC9036	DLC						0.25		0.05	

► Holder >>

- Carbide shank holders for high speed cutting.
- XL (100mm length) is only for Al, Al-alloy cutting, unbalanced <0.6gm.

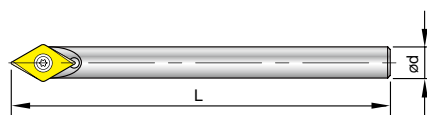
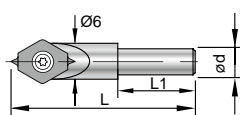

Angle	Code	Parts No.	Shank	Ød	L	L1	Screw	Key
60°	692004	00-99619-V060-04	Steel	4	30	12	*NS-22044 0.9Nm	NK-T7
	692001	00-99619-V060-06	Steel		40	---		
	692002	00-99619-V060-06L	Carbide	6	60	---		
	692003	00-99619-V060-06XL	Carbide		100	---		
	692005	00-99619-V060-08	Steel	8	60	---		

*Torque screwdriver is recommended.

W060 Engraving Tools

60°

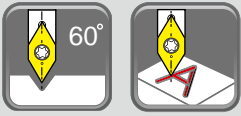

▶ Inserts >>

- Limited design, simply for thin or light engraving, used on engraving machine .
- Shank diameter 4mm is same as insert's size. Slim fits!
- Each insert has 2 cutting edges.

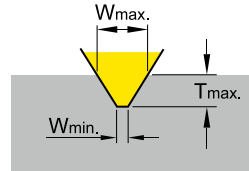

NC2032: • Universal grade for all unhardened steel.

Angle	Code	Parts No.	Coating	Grade	Image	Dimensions		Wmin.	Wmax.	Tmax.
						L	S			
60°	01W2001	W06004S101-NC2032	TiAlN	K20F		4.5	1.3	0.1	0.33	0.2
	01W2002	W06004S102-NC2032						0.2	0.66	0.4
	01W2003	W06004S103-NC2032						0.3	0.99	0.6

▶ Holder >>

- Made from steel.



Angle	Code	Parts No.	Ød	L	Screw	Key
60°	69W001	00-99619-W060-04	4	40	*NS-18037 0.6Nm	NK-T6

*Torque screwdriver is recommended.

▶ Cutting Data >>

S101	Workpiece Material	S (r.p.m)	f (mm/rev.)	Grade of Insert	Depth of cut (mm)					
					1st	2nd	3rd	~	Finishing	
Tmax.: 0.2mm	P Carbon steel C < 0.3%	8000 ~ 40000	0.002 ~ 0.015	NC2032	0.1	0.05	0.03	0.02	0.02	
	P Carbon steel C > 0.3%	8000 ~ 40000	0.002 ~ 0.012	NC2032	0.1	0.05	0.03	0.02	0.02	
	A Alloy steel	8000 ~ 40000	0.002 ~ 0.010	NC2032	0.08	0.03	0.03	0.02	0.02	
	M Stainless Steel	8000 ~ 40000	0.002 ~ 0.010	NC2032	0.08	0.03	0.03	0.02	0.02	
	K Cast iron	8000 ~ 40000	0.002 ~ 0.010	NC2032	0.1	0.05	0.03	0.02	0.02	
	N Aluminum ≥ Non-Ferrous Metal	8000 ~ 40000	0.002 ~ 0.020	NC2032	0.1	0.05	0.03	0.02	0.02	
S102	Workpiece Material	S (r.p.m)	f (mm/rev.)	Grade of Insert	Depth of cut (mm)					
					1st	2nd	3rd	4th	~	Finishing
Tmax.: 0.4mm	P Carbon steel C < 0.3%	8000 ~ 40000	0.002 ~ 0.015	NC2032	0.2	0.1	0.05	0.03	0.03	0.02
	P Carbon steel C > 0.3%	8000 ~ 40000	0.002 ~ 0.012	NC2032	0.15	0.1	0.05	0.03	0.03	0.02
	A Alloy steel	8000 ~ 40000	0.002 ~ 0.010	NC2032	0.12	0.08	0.05	0.03	0.03	0.02
	M Stainless Steel	8000 ~ 40000	0.002 ~ 0.010	NC2032	0.12	0.05	0.05	0.03	0.03	0.02
	K Cast iron	8000 ~ 40000	0.002 ~ 0.010	NC2032	0.15	0.1	0.05	0.03	0.03	0.02
	N Aluminum ≥ Non-Ferrous Metal	8000 ~ 40000	0.002 ~ 0.020	NC2032	0.2	0.1	0.1	0.05	0.03	0.02
S103	Workpiece Material	S (r.p.m)	f (mm/rev.)	Grade of Insert	Depth of cut (mm)					
					1st	2nd	3rd	4th	~	Finishing
Tmax.: 0.6mm	P Carbon steel C < 0.3%	8000 ~ 40000	0.002 ~ 0.015	NC2032	0.25	0.1	0.05	0.05	0.03	0.02
	P Carbon steel C > 0.3%	8000 ~ 40000	0.002 ~ 0.012	NC2032	0.2	0.1	0.05	0.05	0.03	0.02
	A Alloy steel	8000 ~ 40000	0.002 ~ 0.010	NC2032	0.15	0.1	0.05	0.03	0.03	0.02
	M Stainless Steel	8000 ~ 40000	0.002 ~ 0.010	NC2032	0.15	0.05	0.05	0.03	0.03	0.02
	K Cast iron	8000 ~ 40000	0.002 ~ 0.010	NC2032	0.2	0.1	0.05	0.05	0.03	0.02
	N Aluminum ≥ Non-Ferrous Metal	8000 ~ 40000	0.002 ~ 0.020	NC2032	0.3	0.1	0.1	0.05	0.03	0.02

60°
90°

N9MT080201W Engraving Tool 60° / 90°



▶ Inserts >>

- No need to reset tool length after changing insert or cutting edge.
- The inserts can be used for small diameter spotting.
- Each insert has 4 cutting edges.

60-NC40: • Very positive angle for 60° engraving for all kind of unhardened steel and cast iron.

NC40: • Universal grade for all unhardened steel.

NC10: • Universal grade for non-ferrous metal and cast iron.

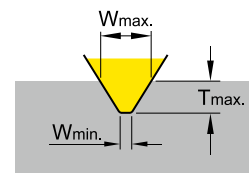

Angle	Code	Parts No.	Coating	Grade	Dimensions		Wmin.	Wmax.	Tmax.
					L	S			
60°	013404	60-NC40	TiN	K20F	8	2.38	0.2	1.1	0.8
90°	013405	N9MT080201W NC40	TiN	K20F			0.2	2.0	0.9
	013406	NC10	TiAlN	K20F			0.2	2.0	0.9

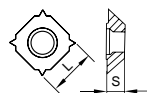

▶ Holder >>

- For SW engraving using NC Spot Drill basic holder.

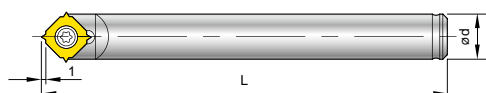

Code	Parts No.	Ød	L	Screw	Key
603001	00-99616-10	10	90	NS-30055 2.0 Nm	NK-T8
613001	00-99616-3/8	3/8"	90		

▶ Cutting Data >>

(Tmax.: 0.8 mm)

Workpiece Material	S (r.p.m)	f (mm/rev.)	Grade of Insert	Depth of cut (mm)			
				1st	2nd	3rd	Finishing
P All unhardened steel	5000 ~ 20000	0.008 ~ 0.02	60-NC40, NC40	0.3	0.2	0.2	0.05
K Cast iron	5000 ~ 20000	0.008 ~ 0.02	60-NC40, NC10	0.3	0.2	0.2	0.05
N Non-Ferrous Metal	5000 ~ 20000	0.008 ~ 0.02	NC10	0.3	0.2	0.2	0.05







3

Engraving Tool

Performance

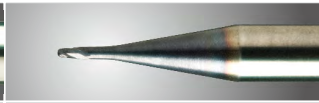
► Comparison >>

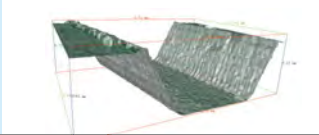
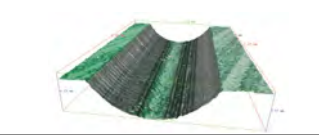
Tool			
Cutting data	00-99619-V060-06 V06006T1W06-NC2071	Engraving tool	Ball nose end mill Radius 0.4 mm
Workpiece material	Tool steel SKD 61 (JIS G 4404), Hardness: HRB92~93 (HB 200)		
Spindle speed r.p.m.	10000	10000	10000
Feed rate mm/min.	100	100	300
Cutting depth A_p	0.2 mm	0.2 mm	0.05 mm, 4 times to cut to 0.2 mm
Roughness of bottom Ra	0.36 μm	0.83 μm	0.46 μm
Change and resetting	No need	Need	Need
Tool life	Long	Short	Short
Measured result by Alicona IFM system			

Cutting data	Tool	00-99619-V060-06 V06006T1W06-NC2071	00-99619-V060-06 V06006T1W06-NC2071	00-99619-V060-06 V06006T1W06-NC2035
Workpiece material		P SKD 51	M SS	H SKD 61 (50HRC)
Spindle speed r.p.m.		10000	10000	10000
Feed rate mm/min.		300	300	100
Cutting depth A_p		0.1 mm	0.35 mm	0.2 mm
Change and resetting		No need	No need	No need
Tool life		24 min.(1440 sec.)	7.2 meters	3.5 meters

► Attention >>

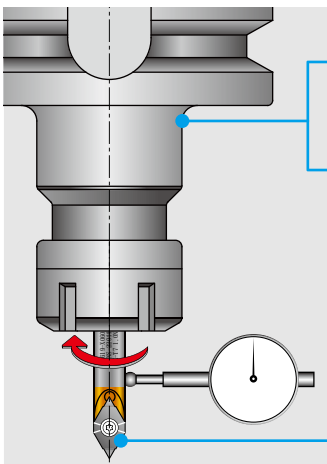

- Recommended of tool holders**
High precision spring collet chucks, shrink fit chucks, hydraulic chuck.
- Pre-balance the tool holder**
minimum **G6.3/10,000** r.p.m. is necessary.
- The downward feed rate of the Z-axis**
should be **reduced to 50%** of the table feed rate.
- Tool shank runout:**
below 0.01 mm.
- Torque screwdriver is recommended**
- Cutting fluid and cooling condition**

Emulsion / Oil	
P Steel	M Stainless Steel
S Titanium	H Hardened Steel
Oil	
N Non-Ferrous	K Cast Iron
Air	

► Clamping the engraving insert

- Place and hold the insert in the insert pocket against the positioning side.

• Step-1

Place the insert in the insert pocket.

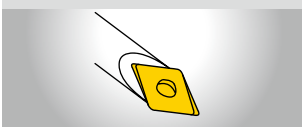

• Step-2

Push insert against insert pocket and insert the screw.



• Step-3

Tighten the insert screw.



Engraving Applications

► Tip >>

Use the V045 and V060 style engravers in materials that tend to push burrs such as stainless steels and high temp. alloys. These inserts have a 0.2mm(0.008") radius with a very sharp cutting edge and cut very freely. Character widths start around 0.45mm(0.017").

This tool best replaces ball nose endmills. This tool is considered to be first choice for all but fine engraving width below 0.25mm.

Components



Luxury goods



Mold & Die



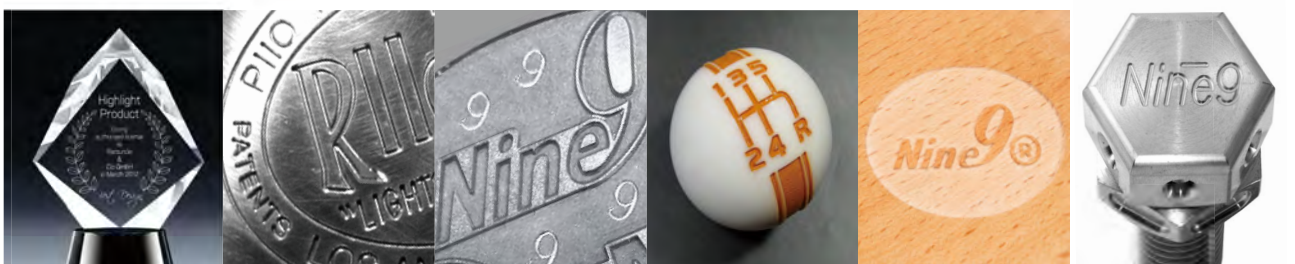

Product



Cutting Data >> X060 Engraving



▶ X060A30W020R / X060A30R020

(Tmax. : 0.6mm)

Workpiece Material	S (r.p.m)	f (mm/rev.)		Grade of Insert	Depth of cut (mm)					
		Radius Angled 	Radius 		1st	2nd	3rd	4th	5th ~	Finishing
P Carbon steel C<0.3%	8000 ~ 40000	0.001 ~ 0.010	0.002 ~ 0.015	NC2032	0.2	0.1	0.05	0.05	0.05	0.02
P Carbon steel C>0.3%		0.001 ~ 0.008	0.002 ~ 0.012	NC2032	0.15	0.1	0.05	0.05	0.05	0.02
P Alloy steel		0.001 ~ 0.006	0.002 ~ 0.010	NC2032, NC2035	0.15	0.1	0.05	0.05	0.03	0.02
M Stainless Steel		0.001 ~ 0.006	0.002 ~ 0.010	NC2032	0.1	0.05	0.05	0.03	0.03	0.02
K Cast iron		0.001 ~ 0.006	0.002 ~ 0.010	NC2032	0.15	0.1	0.05	0.05	0.03	0.02
N Aluminum		0.001 ~ 0.012	0.002 ~ 0.020	XP9001	0.2	0.1	0.1	0.05	0.05	0.02
N Copper, Brass		0.001 ~ 0.012	0.002 ~ 0.020	XP9001	0.2	0.1	0.1	0.05	0.05	0.02
H Hardened Steel Up to 56 HRC		0.001 ~ 0.005	0.002 ~ 0.006	NC2035	0.1	0.05	0.03	0.03	0.02	0.01



▶ X060A45W020R / X060A45R020

(Tmax. : 0.8mm)

Workpiece Material	S (r.p.m)	f (mm/rev.)		Grade of Insert	Depth of cut (mm)					
		Radius Angled 	Radius 		1st	2nd	3rd	4th	5th ~	Finishing
P Carbon steel C<0.3%	8000 ~ 40000	0.002 ~ 0.012	0.002 ~ 0.015	NC2032	0.3	0.2	0.1	0.05	0.05	0.03
P Carbon steel C>0.3%		0.002 ~ 0.010	0.002 ~ 0.012	NC2032	0.25	0.15	0.1	0.05	0.05	0.03
P Alloy steel		0.002 ~ 0.010	0.002 ~ 0.010	NC2032, NC2035	0.2	0.1	0.05	0.05	0.05	0.03
M Stainless Steel		0.002 ~ 0.008	0.002 ~ 0.010	NC2032	0.2	0.1	0.05	0.05	0.05	0.03
K Cast iron		0.002 ~ 0.010	0.002 ~ 0.010	NC2032	0.2	0.1	0.1	0.05	0.05	0.03
N Aluminum		0.002 ~ 0.015	0.002 ~ 0.020	XP9001	0.3	0.2	0.1	0.1	0.05	0.03
N Copper, Brass		0.002 ~ 0.015	0.002 ~ 0.020	XP9001	0.3	0.2	0.1	0.1	0.05	0.03
H Hardened Steel Up to 56 HRC		0.002 ~ 0.006	0.002 ~ 0.006	NC2035	0.15	0.1	0.05	0.05	0.03	0.02

▶ X060A60W020R / X060A60R020

(Tmax. : 1.0mm)

Workpiece Material	S (r.p.m)	f (mm/rev.)		Grade of Insert	Depth of cut (mm)					
		Radius Angled 	Radius 		1st	2nd	3rd	4th	5th ~	Finishing
P Carbon steel C<0.3%	8000 ~ 40000	0.002 ~ 0.012	0.002 ~ 0.015	NC2032	0.3	0.2	0.1	0.1	0.05	0.03
P Carbon steel C>0.3%		0.002 ~ 0.010	0.002 ~ 0.012	NC2032	0.3	0.2	0.1	0.1	0.05	0.03
P Alloy steel		0.002 ~ 0.010	0.002 ~ 0.010	NC2032, NC2035	0.3	0.1	0.1	0.05	0.05	0.03
M Stainless Steel		0.002 ~ 0.008	0.002 ~ 0.010	NC2032	0.2	0.1	0.1	0.05	0.05	0.03
K Cast iron		0.002 ~ 0.010	0.002 ~ 0.010	NC2032	0.3	0.1	0.1	0.05	0.05	0.03
N Aluminum		0.002 ~ 0.015	0.002 ~ 0.020	XP9001	0.3	0.2	0.1	0.1	0.05	0.03
N Copper, Brass		0.002 ~ 0.015	0.002 ~ 0.020	XP9001	0.3	0.2	0.1	0.1	0.05	0.03
H Hardened Steel Up to 56 HRC		0.002 ~ 0.006	0.002 ~ 0.006	NC2035	0.2	0.1	0.05	0.05	0.03	0.02

▶ X060A90W020R

(Tmax. : 1.0mm)

Workpiece Material	S (r.p.m)	f (mm/rev.)	Grade of Insert	Depth of cut (mm)					
				1st	2nd	3rd	4th	5th ~	Finishing
P Carbon steel C<0.3%	8000 ~ 40000	0.002 ~ 0.015	NC2032	0.35	0.25	0.15	0.1	0.05	0.03
P Carbon steel C>0.3%		0.002 ~ 0.012	NC2032	0.3	0.2	0.1	0.1	0.05	0.03
P Alloy steel		0.002 ~ 0.010	NC2032, NC2035	0.3	0.1	0.1	0.05	0.05	0.03
M Stainless steel		0.002 ~ 0.010	NC2032	0.2	0.1	0.1	0.05	0.05	0.03
K Casting iron		0.002 ~ 0.010	NC2032	0.3	0.1	0.1	0.05	0.05	0.03
N Non-ferrous metal (Al, Cu)		0.002 ~ 0.020	XP9001	0.4	0.3	0.2	0.1	0.05	0.03
N Copper, Brass		0.002 ~ 0.020	XP9001	0.4	0.3	0.2	0.1	0.05	0.03
H Hardened steel up 56 HRC		0.002 ~ 0.006	NC2035	0.2	0.1	0.05	0.05	0.03	0.02

3

Engraving Tool

Cutting Data >> V045/V060 Engraving

- To use the engraving chart, select your engraving width (w) on the vertical axis. Select your engraving insert angle (45° or 60°), and follow the horizontal line from the (w) axis to the intersection with the insert angle.
- Follow the vertical line from this intersection point to the engraving depth (t) axis to determine the engraving depth.

▶ V045/V060 T1W06

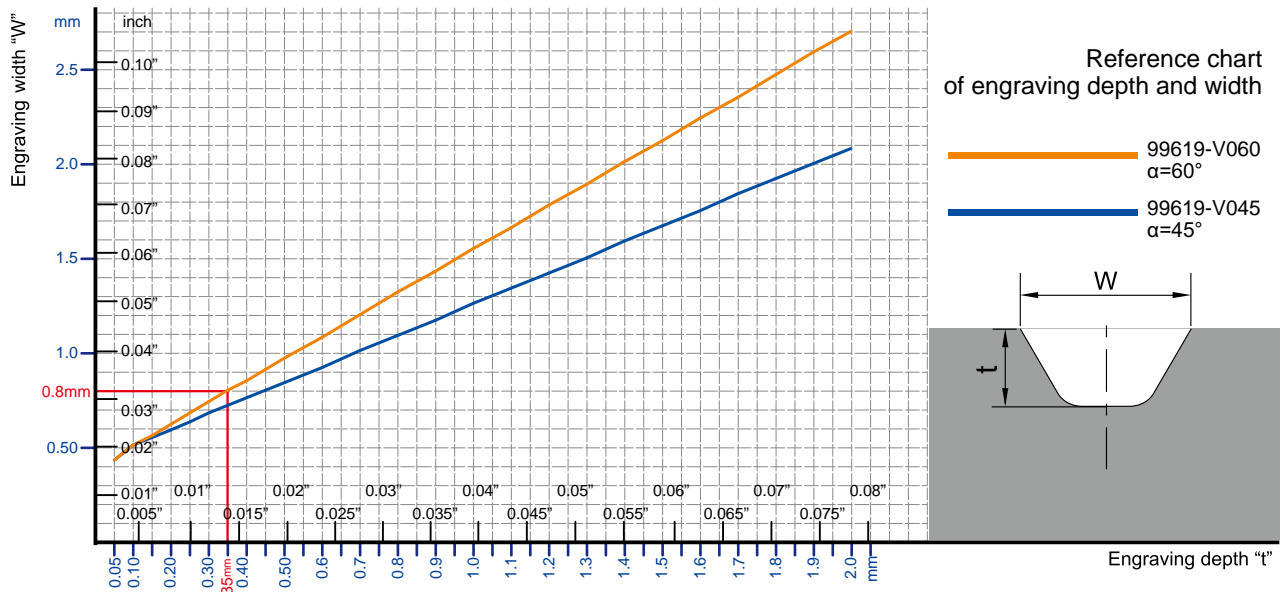

	Work Material	S (r.p.m)	f (mm/rev.)	Grade of Insert
P	Carbon steel	5000~40000	0.008~0.05	NC2071,NC2032
	Alloy steel	5000~40000	0.008~0.03	NC2032,NC2071
M	Stainless steel	5000~40000	0.008~0.05	NC2071,NC9031
K	Casting iron	5000~40000	0.008~0.03	NC2032
N	Aluminum \geq Non-ferrous metal	5000~40000	0.008~0.08	NC2071,NC9031
H	Hardened steel up to 56 HRC	6000~35000	0.003~0.01	NC2035

(Tmax. : 2.0mm)

Material	Ap	(Tmax. : 2.0mm)							
		1st	2nd	3rd	4th	5th	6th	~	Fine finishing
P	Carbon steel	0.8	0.6	0.3	0.2	0.1	~	~	0.05
	Alloy steel	0.5	0.4	0.3	0.3	0.2	0.2	0.1	0.05
M	Stainless steel	0.5	0.4	0.3	0.3	0.2	0.2	0.1	0.05
K	Casting iron	0.8	0.6	0.3	0.2	0.1	~	~	0.05
N	Aluminum \geq Non-ferrous metal	1.0	0.8	0.2	~	~	~	~	0.05
H	Hardened steel up to 56 HRC	0.2	0.2	0.15	0.15	0.1	0.1	0.1	0.05

▶ V060 T1W03

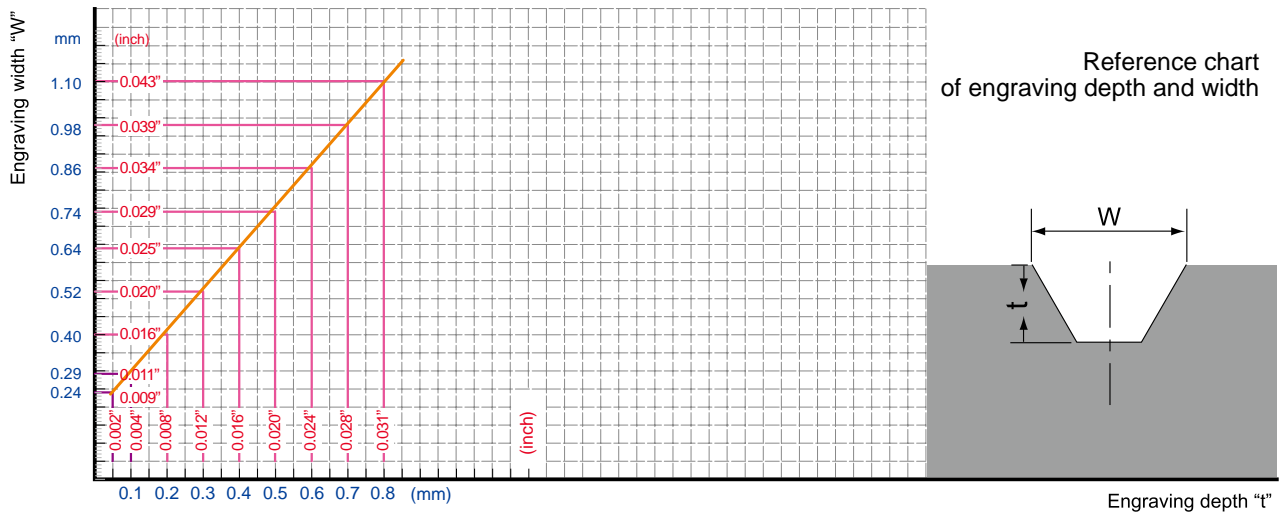

	Workpiece Material	S (r.p.m)	f (mm/rev.)	Grade of Insert
P	Carbon steel C<0.3%	8000 ~ 40000	0.005 ~ 0.010	NC2032
	Carbon steel C>0.3%	8000 ~ 40000	0.005 ~ 0.015	NC2032
	Alloy steel	6000 ~ 35000	0.005 ~ 0.010	NC2032
M	Stainless steel	8000 ~ 35000	0.003 ~ 0.010	NC9036
K	Casting iron	6000 ~ 35000	0.005 ~ 0.015	NC2032
N	Aluminum	8000 ~ 40000	0.005 ~ 0.015	NC9036
	Copper, Brass	8000 ~ 40000	0.005 ~ 0.010	NC9036
S	Titanium	6000 ~ 15000	0.003 ~ 0.010	NC9036

(Tmax. : 0.8mm)

Material		Ap	1st	2nd	3rd	4th	5th	~	Fine finishing
P	Carbon steel C<0.3%		0.3	0.2	0.1	0.1	0.05	0.05	0.03
	Carbon steel C>0.3%		0.3	0.2	0.1	0.1	0.05	0.05	0.03
	Alloy steel		0.3	0.1	0.1	0.05	0.05	0.05	0.03
M	Stainless steel		0.2	0.1	0.1	0.1	0.05	0.05	0.03
K	Casting iron		0.2	0.1	0.1	0.1	0.05	0.05	0.03
N	Aluminum		0.2	0.1	0.1	0.1	0.05	0.05	0.03
	Copper, Brass		0.2	0.1	0.1	0.1	0.05	0.05	0.03
S	Titanium		0.2	0.1	0.1	0.1	0.05	0.05	0.03



NC Deburring >>>

60° & 90°

Ideal for fine hole deburring.





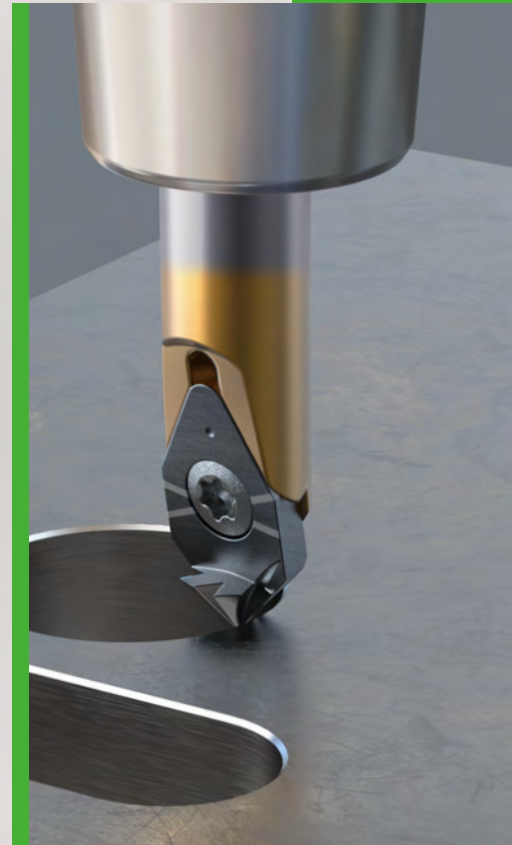

► **Indexable Type, High Precision Ground Carbide Insert.**

- Achieve high speed and high feed deburring and chamfering on CNC machine.
- Retain exceptional positional accuracy of the deburring depth and diameter.

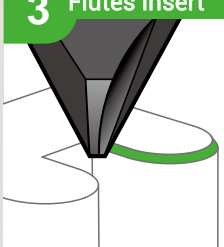

Features >

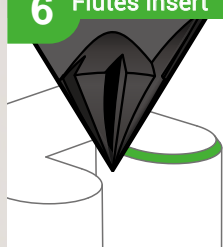
X060A..T3		
3 Flutes insert	2 cutting edges	
	60°	90°
 <ul style="list-style-type: none"> • Good for interior angles < 90°. • The chip removing space is bigger. 	 <p>1 2</p> <p>30° Tmax. 0.9mm</p> <p>Minimum 0.1mm</p> <p>0.5</p>	 <p>1 2</p> <p>45° Tmax. 0.9mm</p> <p>Minimum 0.1mm</p> <p>0.5</p>

X060A..T6		
6 Flutes insert	single cutting edge	
	60°	90°
 <ul style="list-style-type: none"> • Good for simple contours. • Fast deburring, Time saving! 	 <p>1</p> <p>30° Tmax. 1.8mm</p> <p>Minimum 0.1mm</p> <p>0.5</p>	 <p>1</p> <p>45° Tmax. 1.5mm</p> <p>Minimum 0.5mm</p>

NC Deburring 60° & 90°



► Inserts >>

NC2032: • For all kinds of steel < 40 HRC, carbon steel, alloy steel, cast iron, aluminum and non-ferrous metal.

XP9001: • For non-ferrous metal, aluminum, brass, copper, plastic and acrylic.

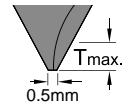

Angle	Code	Part No.	Coating	Grade	Flutes	Diagram	Dimensions		Tmin.	Tmax.
							L	S		
60°	01X611	X060A60T3-NC2032	TiAlN	K20F	3		6	2.8	0.1	0.9
	01X612	X060A60T3-XP9001	Uncoated							
90°	01X911	X060A90T3-NC2032	TiAlN	K20F	3		6	2.8	0.1	0.9
	01X912	X060A90T3-XP9001	Uncoated							
60°	01X601	X060A60T6-NC2032	TiAlN	K20F	6		6	2.0	0.1	1.8
90°	01X901	X060A90T6-NC2032							0.5	1.5

► Holder >>

• Using same tool holder of X060 engraving tool.

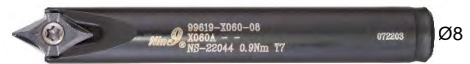

Code	Parts No.	Shank	Ød	L	Screw	Key
69X001	00-99619-X060-06	Steel	6	40		
69X002	00-99619-X060-06L	Carbide	6	60	*NS-22044 0.9Nm	NK-T7
69X003	00-99619-X060-06LS	Steel	6	60		
69X004	00-99619-X060-06XL	Carbide	6	100		
69X005	00-99619-X060-08	Steel	8	60		

*Torque screwdriver is recommended.

► Starter Kit >> • Different content can be customized.

Code	Parts No.	Carbide Shank Ø	Angle	Insert included	Content
69X202-X601	00-99619-X060-DB60-02K-32	6	60°	X060A60T6-NC2032	1 x Holder 1 x T7 Key
69X202-X901	00-99619-X060-DB90-02K-32	(99619-X060-06L)	90°	X060A90T6-NC2032	2 x inserts



► Cutting Data >>

Workpiece Material	S (r.p.m.)	Feed Rate (mm / tooth)	Grade of Insert
P Carbon Steel C<0.3%	8000~40000	0.005-0.05	NC2032
Alloy steel	6000~35000	0.005-0.04	
M Stainless Steel	6000~25000	0.005-0.03	
K Casting iron	6000~35000	0.005-0.03	
N Aluminum, Non-Ferrous Metal	8000~40000	0.005-0.05	XP9001

Deburring Mill >>>

60° & 90°

For both front and back deburring and threading applications.

P M K N H

▶ **2 Angles : 60° / 90°**

- One holder can fit on both the 60° and 90° deburring inserts.

▶ **6 Cutting Flutes**

- provide higher feed rate, optimized performance and reduced cycle time.

▶ **Ø5(mm)**

90° insert

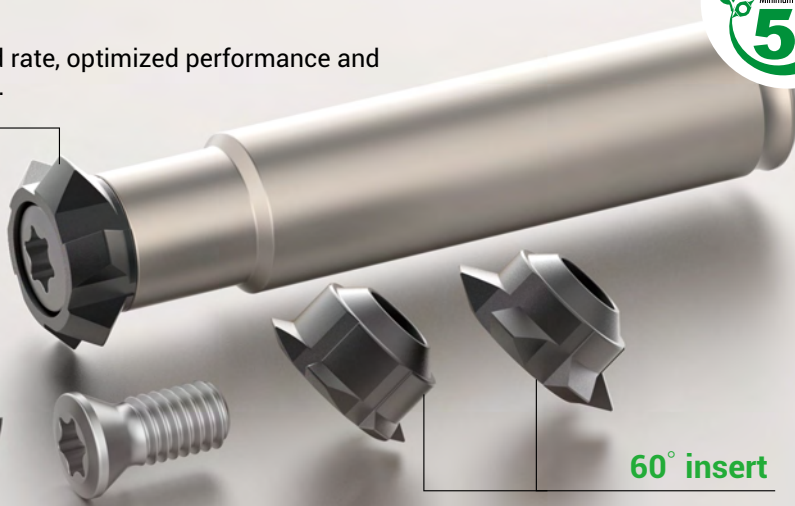

60° insert



Features >>>

▶ **Deburring Mill 60°**

- Front & back deburring in one operation.
- Mini. deburring bore from Ø3.9 ~ Ø10mm.
- Also for thread milling application.
- Each insert has 6 flutes.
- Thanks for special insert geometry and Nine9 clamping system to provide high precision and accurate position.
- The smallest insert Ø5.0 can do M6xP0.75 internal threading and deburring.
- For external different threading pitch can be done by NC programming.
For example: Ø10.0mm insert can do external, threading pitch from P1.25 to P2.0mm, save your tool inventory.

▶ **Deburring Mill 90°**

- For front & back deburring, grooving is also possible.
- Mini. deburring bore from Ø3.9 ~ Ø10mm.
- Each insert has 6 flutes.



Applications



60°

- Front and back deburring and thread milling in one operation.



90°

For front and back
Deburring
Smallest size
from 5mm

C0.2

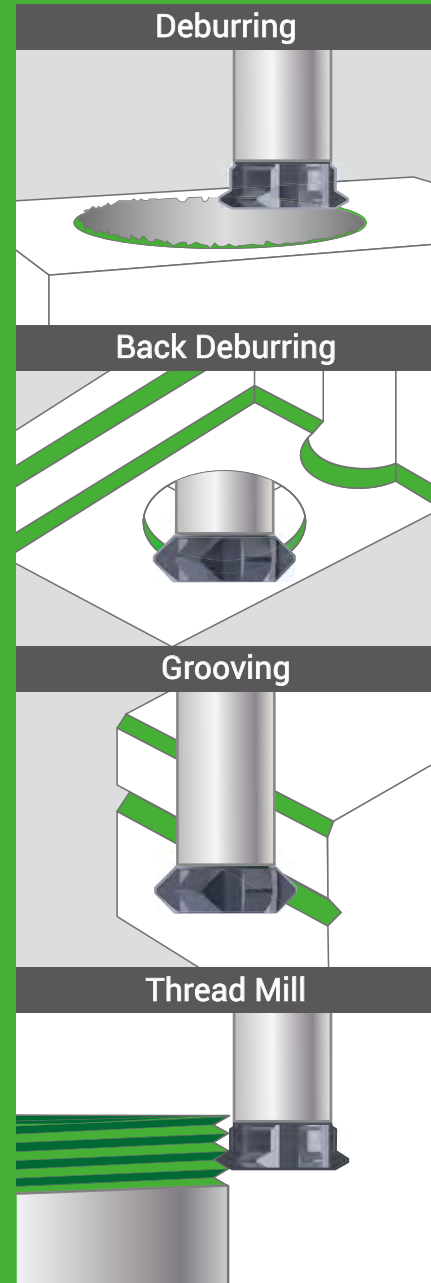

“

- Specialized on narrow space below 10mm by indexable inserts.
- 6 cutting flutes, higher feed rate, good for hardened steel up to HRC60.

”

4

Deburring Mill

Deburring Mill 60° & 90°

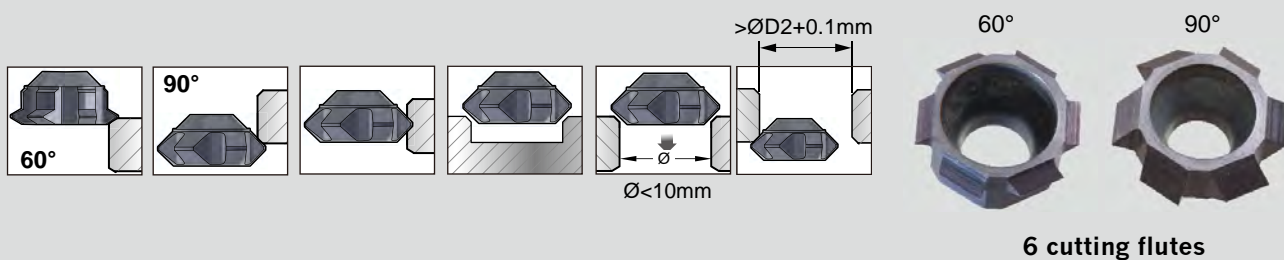

► Inserts >>

NC2032: • TiAlN coating provides longer tool life.

- For all kinds of steel < 60 HRC, carbon steel, alloy steel and cast iron.

XP9000: • High positive geometry and sharp edge produces excellent surface finish.

- For non-ferrous material such as aluminum, titanium, brass, copper and long cutting chip metal.

► 60° deburring mill

- For front and back deburring.
- Also for threading application.



Code	Parts No.	Coating	Grade	ØD1	ØD2	L	LC1	LC2	LC3	LC4	S	Pitch Range		Plunge 0.1C			
												mm	TPI	min. hole	max. hole		
01R2101	R06005-05006-32	TiAlN	K20F		3.9	5.0	0.06	0.03	0.35	0.41	2.45	2.45	0.7 - 0.75	28 - 24	4.1	4.8	
01R2102	R06005-05006-00	Uncoated			3.9	5.0	0.1	0.03	0.32	0.42	2.45	2.45	0.8 - 1.0	28 - 24	4.1	4.8	
01R2103	R06005-05010-32	TiAlN			5.5	6.8	0.1	0.03	0.40	0.50	3.25	3.25	0.8 - 1.25	20	5.7	6.6	
01R2104	R06005-05010-00	Uncoated			6.9	8.5	0.1	0.03	0.49	0.59	4.60	4.60	1.0 - 1.5	18 - 16	7.1	8.3	
01R2301	R06007-06810-32	TiAlN			6.9	10.0	0.1	0.03	0.92	1.02	4.60	4.60	1.0 - 2.0	14 - 9	7.1	9.8	
01R2302	R06007-06810-00	Uncoated															
01R2601	R06010-08510-32	TiAlN															
01R2602	R06010-08510-00	Uncoated															
01R2603	R06010-10010-32	TiAlN															
01R2604	R06010-10010-00	Uncoated															

► 90° deburring mill

- Front & back deburring in one operation.

Code	Parts No.	Coating	Grade	ØD1	ØD2	L	LC1	LC2	LC3	LC4	S	Plunge 0.1C			
												min. hole	max. hole		
01R4101	R09005-05060-32	TiAlN	K20F		3.9	5.0	0.6	0.05	0.6	1.2	1.77	2.45	4.1	4.8	
01R4102	R09005-05060-00	Uncoated			5.1	7.0	0.2	0.05	1.0	1.2	2.17	3.25	5.3	6.8	
01R4301	R09007-07020-32	TiAlN			7.2	10.0	0.1	0.05	1.45	1.55	2.97	4.60	7.4	9.8	
01R4302	R09007-07020-00	Uncoated													
01R4601	R09010-10010-32	TiAlN													
01R4602	R09010-10010-00	Uncoated													

Deburring Mill 60° & 90°

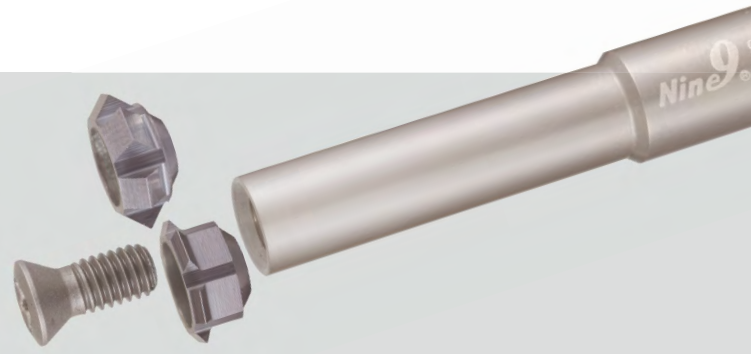

► Holder >>

- Made of hardened high alloy steel.
- For both 60° and 90° deburring inserts.

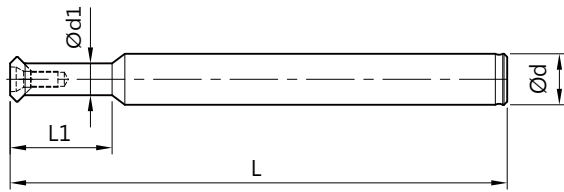

Code	Parts No.	Type	Ød	Ød1	L1	L	Insert Type	Screw	Key
70R102	00-99626-CR05-05-031	BC05-CR05-031	5	3.5	6	31			
70R103	00-99626-CR05-08-076	BC08-CR05-076	8	3.5	12	76	Rxxx05	*NS-20045 0.6Nm	NK-T6
70R101	00-99626-CR05-05-043	BC05-CR05-043	5	3.5	18	43			
70R302	00-99626-CR07-06-036	BC06-CR07-036	6	5	8	36			
70R303	00-99626-CR07-08-078	BC08-CR07-078	8	5	16	78	Rxxx07	NS-25060 0.9Nm	NK-T7
70R301	00-99626-CR07-06-052	BC06-CR07-052	6	5	24	52			
70R602	00-99626-CR10-08-040	BC08-CR10-040	8	6.8	10	40			
70R603	00-99626-CR10-08-082	BC08-CR10-082	8	6.8	20	82	Rxxx10	NS-35080 2.5Nm	NK-T15
70R601	00-99626-CR10-08-070	BC08-CR10-070	8	6.8	30	70			

*Torque screwdriver is recommended.

► Cutting Data >>

60° & 90° deburring mill for deburring

	Workpiece material	Vc (m/min.)	Feed rate (mm / tooth)	Grade of insert
P	Carbon steel	120 ~ 250	0.005 ~ 0.12	NC2032
	Alloy steel	100 ~ 200	0.005 ~ 0.10	NC2032
M	Stainless steel	60 ~ 150	0.005 ~ 0.10	NC2032
K	Casting iron	80 ~ 180	0.005 ~ 0.10	NC2032
N	Al, and non-ferrous metal	150 ~ 500	0.005 ~ 0.15	XP9000
H	Hardened steel < 60 HRC	40 ~ 100	0.005 ~ 0.05	NC2032

60° deburring mill for thread milling

	Workpiece material	Vc (m/min.)	Feed rate (mm / tooth)	Grade of insert
P	Carbon steel	80 ~ 150	0.002 ~ 0.013	NC2032
	Alloy steel	60 ~ 120	0.002 ~ 0.01	NC2032
M	Stainless steel	50 ~ 100	0.002 ~ 0.01	NC2032
K	Casting iron	50 ~ 100	0.002 ~ 0.01	NC2032
N	Al, and non-ferrous metal	100 ~ 300	0.002 ~ 0.013	XP9000
H	Hardened steel < 60 HRC	30 ~ 60	0.002 ~ 0.008	NC2032

4

Deburring Mill



Chamfer Mill >>>

45° Front And Back Chamfering!

Nine9 chamfer mill

is designed for chamfering and countersinking with indexable inserts.

The insert is a specifically designed for high speed machining ; the multiple flutes provide for increased feed rate, optimizing performance and reducing cutting time.



► Economical

- Each insert has 4 cutting edges.
- Long tool life.



Features >>>

► Excellent Repeatability

- Smallest Indexable counter sink, diameter $\varnothing 7$ mm.
- The insert is dual-relief angle, specially edge honing and optimized coated for high cutting speed.
- Optimized the number of teeth on the holder to achieve higher feed rate.



► Applications

- For front and back chamfering.
- 90° counter sink and 45° chamfering.
- For counter sink, circular chamfering, contour chamfering and face milling.

► Eliminate 2nd Operation Or Deburring Time.



Applications

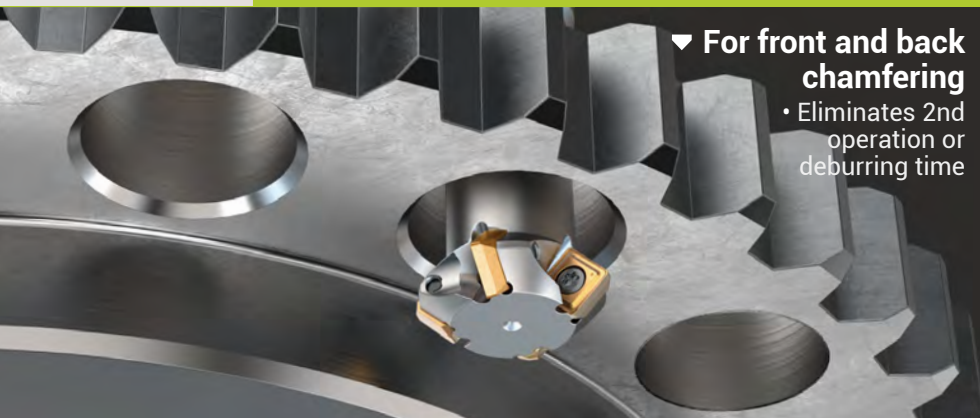
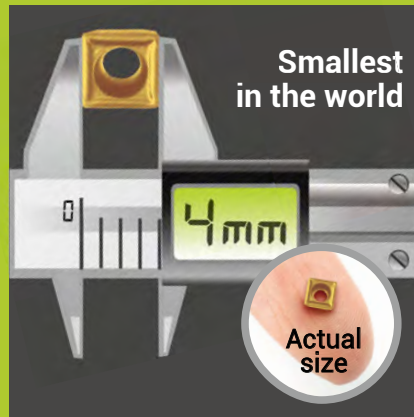

4

“

- Ultra high speed and feed rate.
- 4 times faster in cutting speed and up to 10 times higher in feed rate.

”

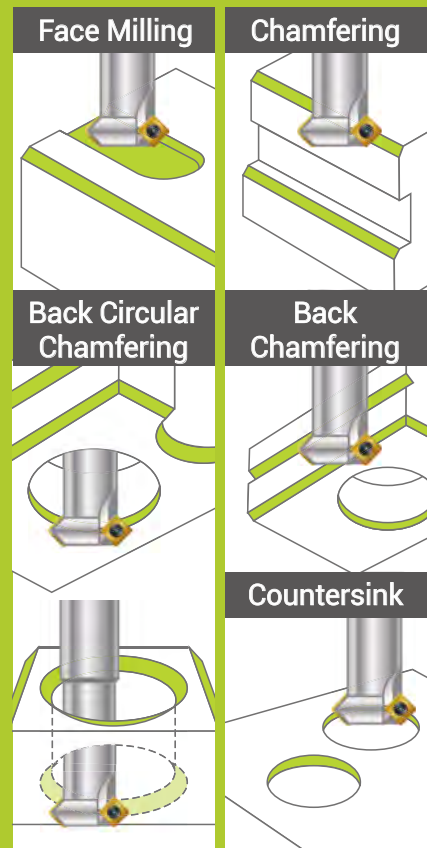

Chamfer Mill

Indexable Chamfer Mill

► Features >>

- Benefiting from the specially ground dual-relief insert and optimized coating, higher feed rate and cutting speed can be achieved on chamfering operation.
- Each insert has 4 cutting edges, reducing insert cost.
- Fine edge honning cutting edge, good chip breaking condition and long tool life.

► Inserts >>

NC2032: • AITiN coating, very long tool life.

- For carbon steel, alloy steel, cast iron and hardened steel up to 56HRC
- Each insert has 4 cutting edges.

NC9071: • TiN coating, very sharp cutting edge produces excellent surface finish

- For non ferrous metal, aluminum, aluminum-alloy, brass, copper and stainless steel.
- Each insert has 4 cutting edges.

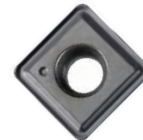

NC2032



NC9071

Code	Parts No.	Coating	Grade	Dimensions			Screw	Key	
				L	S	Re			
021401	N9GX04T002	NC2032	K20F		4.0	1.8	0.2	*NS-18037 0.6Nm	NK-T6
021402		NC9071							
023401	N9GX060204	NC2032			6.35	2.38	0.4	*NS-22055 0.9Nm	NK-T7
023402		NC9071							
025401	N9GX090308	NC2032			9.52	3.18	0.8	NS-30072 2.0Nm	NK-T9
025402		NC9071							

*Torque screwdriver is recommended.

► Holder >>

- Made of hot working steel and hardened.
- Elliptical necked bar to optimize the tool strength.
- Shank is ground to h6 tolerance.

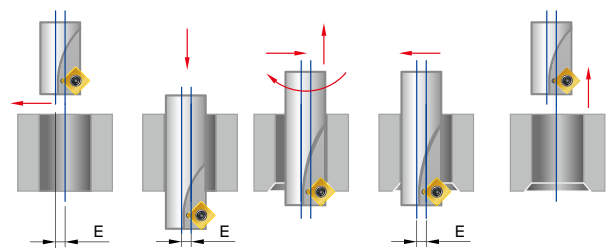
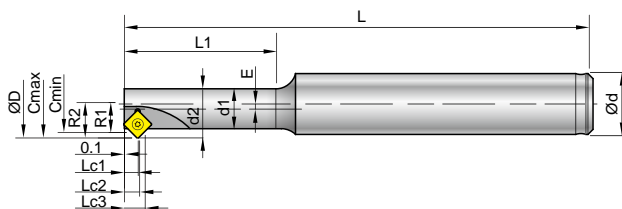

Code	Parts No.	Type	Cmin ø	Cmax ø	ød	ød1	ød2	øD	R1	R2	L	L1	Lc1	Lc2	Lc3	E	⊙z	insert Screw / Key
701003	00-99616-C02	BC10-C02-80	6.8	8.8	10	5.25	6.5	9	3.4	4.4	80	20	2.56	2.93	3.93	1.25	1	N9GX04T002
701004	00-99616-C04	BC12-C04-100	8.5	10.8	12	6.45	8	11.1	4.25	5.4	100	25	2.51	2.98	4.13	1.55	1	*NS-18037 0.6Nm NK-T6
701005	00-99616-C06	BC12-C06-100	10.26	13.2	12	7.88	9.75	13.5	5.13	6.6	100	30	2.51	2.98	4.45	1.88	1	

*Torque screwdriver is recommended.

► Holder >>

- Made from tool steel.
- Shank is ground to h6 tolerance.

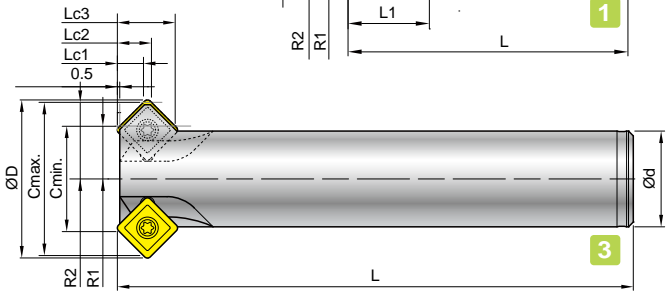
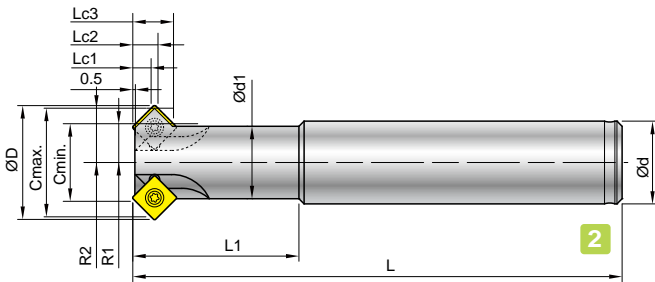
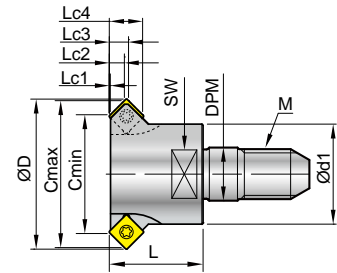

Fig	Code	Parts No.	Type	Cmin ø	Cmax ø	ød	ød1	øD	R1	R2	L	L1	Lc1	Lc2	Lc3	Øz	insert Screw / Key
1	701001	00-99616-C10	BC10-C07-60	7	11	10	7.5	12	3.5	5.5	60	15	2.6	2.9	4.6	2	N9GX04 NS-18037 0.6Nm NK-T6
	701002	00-99616-C20	BC12-C11-100	11	16	12	9.6	16.15	5.5	8.0	100	25	2.6	2.9	5.0	4	
2	703001	00-99616-C30	BC16-C15-120	15	21	16	14	22	7.5	10.5	120	40	3.5	4.9	7.9	4	N9GX06 NS-22055 0.9Nm NK-T7
	703002	00-99616-C40	BC20-C19-130	19	25	20	18	26	9.5	12.5	130	50	3.5	4.9	7.9	4	
3	705001	00-99616-C50	BC20-C22-130	22	32	20	--	33	11	16	130	--	5.5	7.1	12.1	4	N9GX090 NS-30072 2.0Nm NK-T9
2	705002	00-99616-C52	BC25-C22-180	22	32	25	20	33	11	16	180	80	5.5	7.1	12.1	4	

*Torque screwdriver is recommended.

► Screw Fit Cutter >>

- Quick and easy to change system and provides chamfering flexibility.
- Capable of extended overhangs by almost any kind of the screw-fit tool holder or extension bar in the market.



Code	Parts No.	Type	Cmin ø	Cmax ø	øD	M	SW	ød1	DPM	L	Lc1	Lc2	Lc3	Lc4	Øz	insert Screw / Key
721101	00-99616-CM16-M05	M05-CM16	11	16	16.15	M5	8	10	5.5	15	0.09	2.59	2.9	5.4	3	N9GX04 NS-18037 0.6Nm / NK-T6
721201	00-99616-CM20-M06	M06-CM20	15	20	20.15	M6	11	12	6.5	16	0.09	2.59	2.9	5.4	4	
723301	00-99616-CM23-M08	M08-CM23	19	23.5	24	M8	14	16	8.5	19	0.16	2.41	3.08	5.33	4	
723401	00-99616-CM29-M10	M10-CM29	23	29	30	M10	18	20	10.5	17	0.54	3.54	4.87	7.87	4	N9GX06 NS-22055 0.9Nm / NK-T7

* Refer to page 9-156 for extension bars.

*Torque screwdriver is recommended.

► Starter Kit >>

Fig	Code	Parts No.	Insert included	Holder included	Content
1	701201-1401	00-99616-C1020-32	N9GX04T002-NC2032	00-99616-C10	2 x holders + 10 inserts + 1 key
	701201-1402	00-99616-C1020-71	N9GX04T002-NC9071	00-99616-C20	
2	703201-3401	00-99616-C3040-32	N9GX060204-NC2032	00-99616-C30	
	703201-3402	00-99616-C3040-71	N9GX060204-NC9071	00-99616-C40	
3	705201-5401	00-99616-C5052-32	N9GX090308-NC2032	00-99616-C50	
	705201-5402	00-99616-C5052-71	N9GX090308-NC9071	00-99616-C52	



Performance

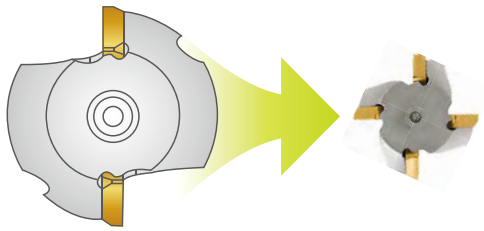

Feed Rate = Feed per Tooth x Spindle Speed x **No. of Flute** mm/min.

UP **Spindle Speed =** $\frac{\text{Cutting Speed} \times 1000}{\pi \times C \text{min.}}$

► Comparison >>

- Chamfer tool with larger insert(Sxxx1204) and Nine9 N9GX04 insert.

Tool			
Cutting data		Nine 9 Chamfer mills	Other makers with Large insert
Chamfering		1 mm	1 mm
Feed rate	mm/rev.	0.1	0.1
Dia. of cutter	mm	11	32
Teeth of cutter		4	2
Cutting Speed Vc	m/min.	300	200
Spindle Speed	r.p.m.	8685	1990
Feed rate	mm/min	3474	398

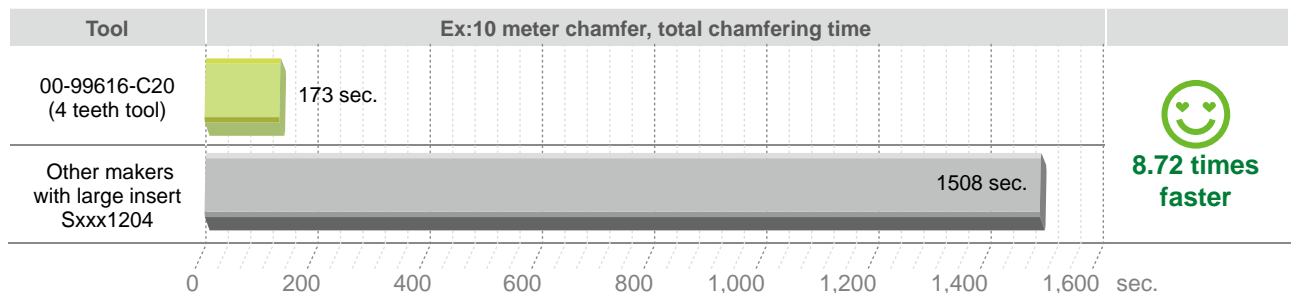
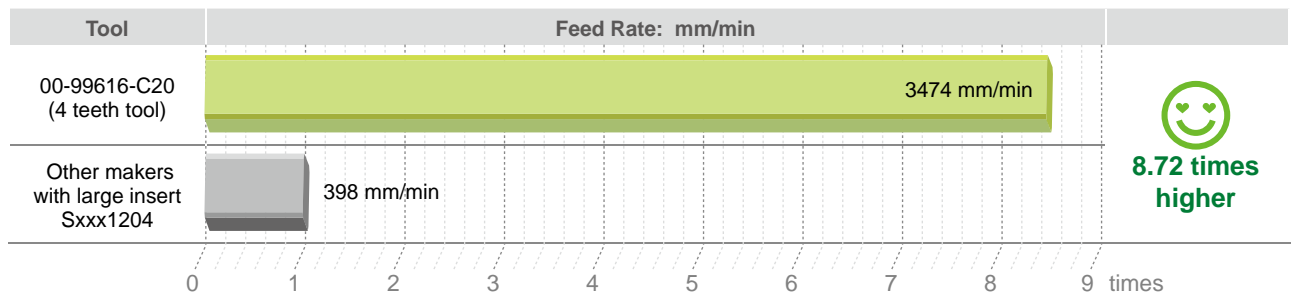

Cutting Data

▶ 99616-C02, C04, C06 Cutting Data >>

Workpiece Material		Cutting Speed VC (m/min.)	Feed Rate (mm / tooth)	Grade of Insert	
Material Group	Sample Code (JIS)		N9GX04T002		
			Max. Chamfering 1.5mm		
P	Carbon steel C<0.3%	SS400	60-80-120	0.02 ~ 0.07	NC9071
	Carbon steel C>0.3%	S50C, P5	60-80-120	0.02 ~ 0.07	NC2032
	Low alloy steel C<0.3%	SCM420	60-80-120	0.01 ~ 0.04	NC9071
	High alloy steel C>0.3%	SKD11	60-80-120	0.02 ~ 0.07	NC2032
M	Stainless steel	SUS304	30-60-100	0.01 ~ 0.04	NC9071
K	Cast iron	FC25	60-80-120	0.02 ~ 0.06	NC2032
N	Al, and non-ferrous metal	A6061	80-100-150	0.03 ~ 0.10	NC9071

▶ 99616-C10~C52 Cutting Data >>

Workpiece Material		Cutting Speed VC (m/min.)	Feed Rate (mm / tooth)			Grade of Insert	
Material Group	Sample Code (JIS)		N9GX04T002	N9GX060204	N9GX090308		
			Max. Chamfering 1.5mm	Max. Chamfering 2.5mm	Max. Chamfering 4mm		
P	Carbon steel C<0.3%	SS400	150-250-350	0.06~0.12	0.10~0.25	0.10~0.25	NC9071
	Carbon steel C>0.3%	S50C,P5	200-300-400	0.06~0.10	0.10~0.20	0.10~0.25	NC2032
	Low alloy steel C<0.3%	SCM420	180-240-260	0.06~0.10	0.10~0.20	0.10~0.20	NC9071
	High alloy steel C>0.3%	SKD11	120-150-200	0.06~0.10	0.10~0.15	0.10~0.15	NC2032
M	Stainless steel	SUS304	120-150-180	0.06~0.10	0.06~0.15	0.10~0.20	NC9071
K	Cast iron	FC25	120-150-180	0.06~0.10	0.10~0.15	0.10~0.20	NC2032
N	Al, and non-ferrous metal	A6061	200-400-600	0.06~0.15	0.10~0.25	0.10~0.25	NC9071
H	Hardened steel<50 HRC	SKD61	80-90-100	0.06~0.10	0.06~0.12	0.10~0.15	NC2032



ER Indexable Cutter >>>

ERgo just say "ergo".

The Ergo is a new trademark of Nine9 for ER type indexable cutter. Better rigidity, quick change, excellent repeatability, tool length maintain, and pre-balanced.



▶ 3 Different Sizes Of Integrated ER Taper-Shank Cutter

- ER11 / ER16 / ER20



Concept >>>

- ▶ **An Integrated ER Taper-Shank Cutter, Eliminate Assembly Tolerance.**
- ▶ **A Clamping Force Gained From The 3 Parts Including Ergo Nut, High Strength Ergo Pin And ER Taper.**
- ▶ **Ergo Nut Drives The Pin To Push Ergo Holder Into ER Taper. It Is " A simple way to maximize clamping force "**
 - Short tool length and quick change system for adapting on small working area.
 - Ideal solution for BT30, driven tools, tapping and turning center.
 - Increase tool life.
 - Easy and simple assembly.
- ▶ **Ergo Provide Customized Tooling Service.**



Applications

**Quick Change,
Saving Huge
Machine Downtime.**

- The simplest way to get tools on the machine.
- 3 fixed tool length groups of Ergo system.
- No need to reset tool length while changing tools in the same group.



“ The Ergo system includes milling cutter, spot drills, engraving tools, deburring tools, chamfering tools, and center drills. ”

OAL: 33.5mm Group
Tool Length Setter

Multi-Functional Tool

Engraving & Deburring







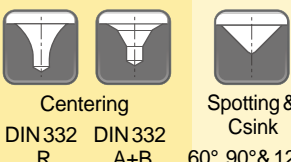
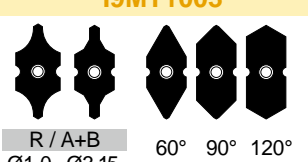
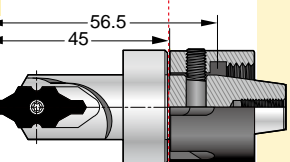
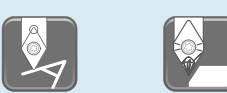

Chamfer Mill

OAL: 26mm Group
Power Mill $\varnothing 10 \sim \varnothing 32\text{mm}$

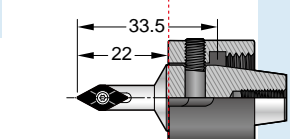
OAL: 56.5mm
i-Center

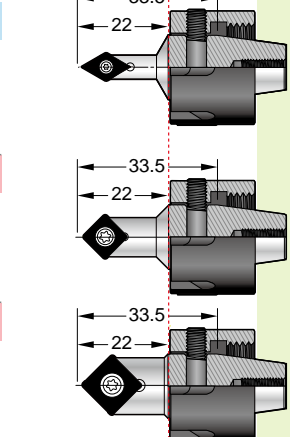
5

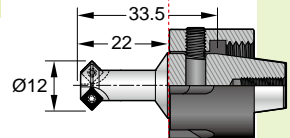
Ergo

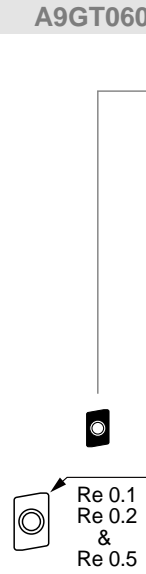
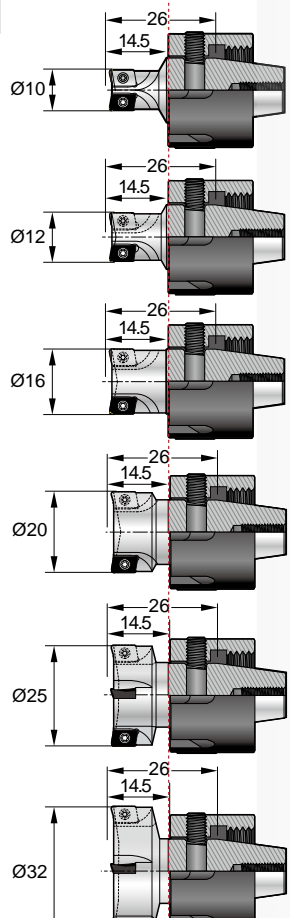
<p>ER16</p>	<p>i-Center Internal coolant G6.3 10,000 r.p.m.</p>	 <p>Centering DIN 332 R DIN 332 A+B</p> <p>Spotting & Csink 60°, 90° & 120°</p>	<p>I9MT1003</p>  <p>R / A+B 60° 90° 120° Ø1.0-Ø3.15</p>	
<p>ER16</p>	<p>X060 G4.0 20,000 r.p.m.</p>	 <p>Spotting/Engraving 30° ~ 142°</p> <p>Deburring 60° & 90°</p>	<p>X060</p>  <p>30° 45° 60° 90° 120° 142° 60° 90°</p>	
<p>ER16</p>	<p>Multi-Functional Tool G6.3 10,000 r.p.m.</p>	 <p>Spotting Chamfering</p>	<p>V060 60°</p> <p>N9MT0802 90°</p> <p>N9MT11T3 90°</p>	
<p>ER16</p>	<p>Chamfer Mill G6.3 10,000 r.p.m.</p>	 <p>Front & Back Chamfering Face Milling</p>	<p>N9GX04T002 45°</p>	
<p>ER11</p> <p>ER16</p> <p>ER20</p>	<p>Power Mill G6.3 10,000 r.p.m.</p>	 <p>Ø10 Ø32</p> <p>Smaller, sharper and more effective teeth.</p>	<p>A9GT0602</p>  <p>Re 0.1 Re 0.2 & Re 0.5</p>	

99816-IC10BH

OAL
||
56.5
mm

99816-X060

99816-V060

99816-610

99816-614

99816-C10

OAL
||
33.5
mm

99816-10A06

99816-12A06

99816-16A06

99816-20A06

99816-25A06

99816-32A06

OAL
||
26
mm

Center distance: 33mm
(ER16 M19)

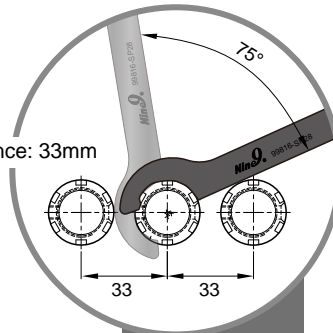

ER
11

ER
16

ER
20

Pin & Nut
are sold separately.

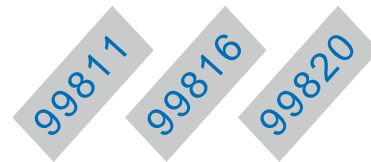
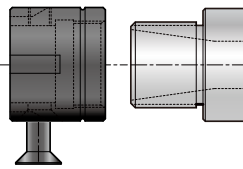

Ergo system can apply on live spindle tool of turning centers and swiss type automatic lathes, such as Star, Citizen, Doosan, Tsugami, Tornos, INDEX, EMAG...and so on. And also good for tapping and machining centers.

Center distance: 39mm
(ER16 M22)

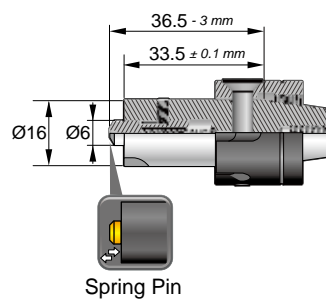
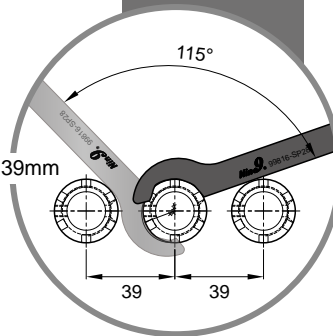

Ergo
Setter TP





99816-TP

refer to
Page 5-104

Ergo's Features



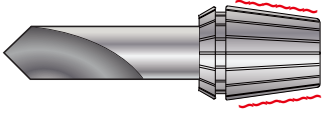

► Optimize the rigidity >>

- An integrated ER taper- shank cutter, eliminate assembly tolerance.
- Pre-balanced, ready for high speed machining. Increase tool life.

Ergo Integrated design	Cutting tool + Spring collet
  <ul style="list-style-type: none"> • Improve tool concentricity • Increase rigidity 	  <ul style="list-style-type: none"> • When tightening ER nut, be cautious of uneven tightening situation. • Chips, rust, or collet deform.

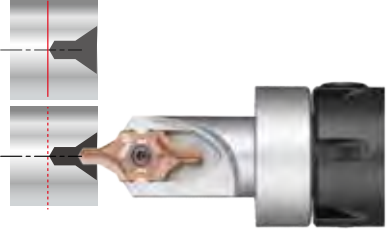

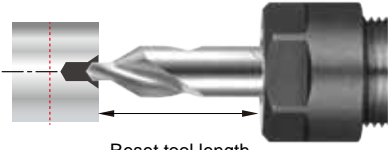

► Excellent repeatability, saving set-up time >>

- The greatest benefit is saving the tool changing time and tool length setting time.
- The drilling depth is constant after change the insert or cutting edge.

Ergo indexable cutter	Solid carbide center drill
 	 <p>Reset tool length every time after tool changed</p> 

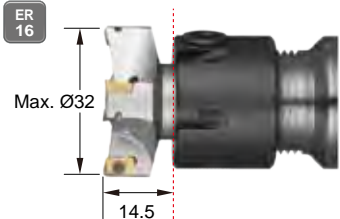

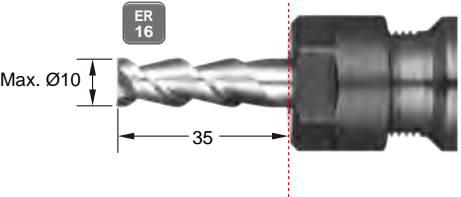
► Dimension is not limited by the ER16 collet clamping range >>

- Cover milling cutter range from $\varnothing 10$ to $\varnothing 32$ mm.
- More efficiency and the possibilities to cut bigger parts.
- The shorter tool length, the better run-out accuracy.

Ergo indexable cutter	Solid carbide end mill
 	 

► Easy and simple assembly >>

- A simple Ergo cutter has minimal assemble parts, saving 50% your time.
- Thanks to ER taper, the repeatability of assemble tolerance is ± 0.1 mm while changing same tool length of Ergo holder.

Ergo cutter	Solid carbide cutter
 	 

i-Center Indexable Center Drill

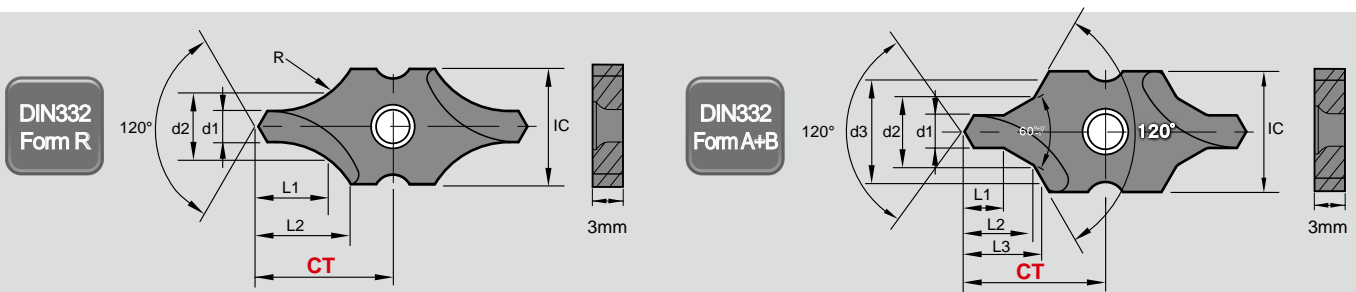

► For DIN332 Form R Center Hole >>

IC	Code	Parts No.	Coating	Grade	d1	d2	L1	L2	R	CT ±0.025
10	031200	I9MT1003R0100-NC2057	AlTiN+TiSiN	P35	1.00	2.12	2.16	4.72	2.8	12.35
	031201	I9MT1003R0125-NC2057			1.25		2.74	5.22	3.5	
	031202	I9MT1003R0150-NC2057			1.50		3.67	6.14	5.0	
	031203	I9MT1003R0160-NC2057			1.60		3.45	5.32	4.5	
	031204	I9MT1003R0200-NC2057			2.00	4.25	4.45	6.50	5.65	
	031205	I9MT1003R0250-NC2057			2.50	5.30	5.59	7.66	7.15	
	031206	I9MT1003R0300-NC2057			3.00	5.70	6.92	9.50	10.00	
	031207	I9MT1003R0315-NC2057			3.15	6.70	7.21	8.93	9.00	



► For DIN332 Form A+B Center Hole >>

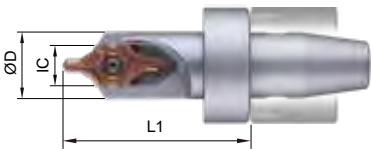

IC	Code	Parts No.	Coating	Grade	d1	d2	d3	L1	L2	L3	CT ±0.025	
10	031000	I9MT1003B0100-NC2057	AlTiN+TiSiN	P35	1.00	2.12	3.15	1.3	2.21	2.51	12.35	
	031001	I9MT1003B0125-NC2057			1.25		4.00	1.6	2.75	3.14		
	031002	I9MT1003B0150-NC2057			1.50		3.18	4.50	2.0	3.45		3.84
	031003	I9MT1003B0160-NC2057			1.60		3.35	5.00	2.0	3.46		3.93
	031004	I9MT1003B0200-NC2057			2.00	4.25	6.30	2.5	4.39	4.98		
	031005	I9MT1003B0250-NC2057			2.50	5.30	8.00	3.1	5.53	6.28		
	031006	I9MT1003B0300-NC2057			3.00	6.46	9.00	4.1	7.10	7.83		
	031007	I9MT1003B0315-NC2057			3.15	6.70	10.0	3.9	6.90	7.85		

► Basic Holder >> • G6.3 / 10,000 r.p.m. • With internal coolant.

IC	Code	Parts No.	Basic Holder	L1	øD	Screw	Key
10	16-801003	00-99816-IC10BH		16	45	*NS-25060/ 0.9Nm	NK-T7

*Torque screwdriver is recommended.

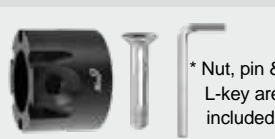
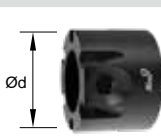
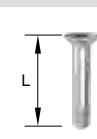
► Accessories - Set & Spare >>

Set	Ergo Nut	High Strength Ergo Pin	L-Key	Ergo Spanner						
 * Nut, pin & L-key are included.										
ER	Parts No.	Parts No.	Ød	Pitch	Torque	Parts No.	L	Torque	Parts No.	Parts No.
ER16	00-99816-M19S	00-99816-M19	25	M19xP1.0	30 Nm	NS-50025	25	5 Nm	NK-LW3	00-99816-SP28
	00-99816-M22S	00-99816-M22	28	M22xP1.5	30 Nm	NS-50028	28	5 Nm		

i-Center Spotting & Countersink

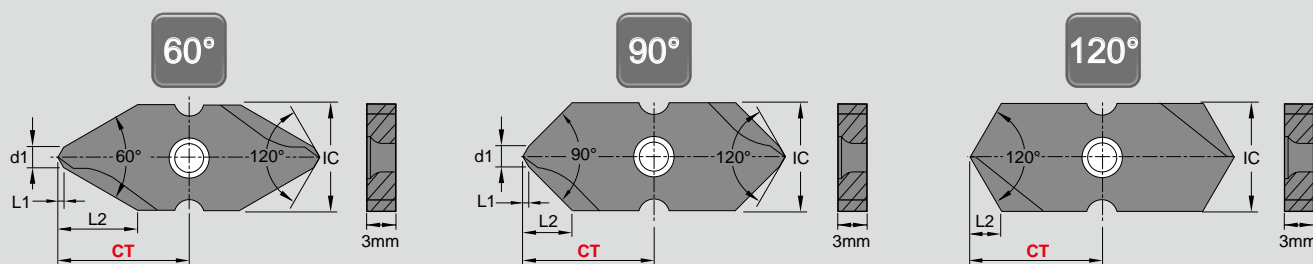

► Insert >>

- Double-edged cutting, fully ground insert for improving machining stability.
- NC2057: Universal grade for all kind of steel.
- Each insert has 2 cutting edges.

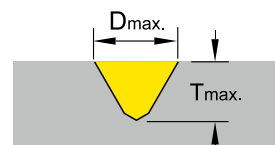

IC	Angle	Code	Parts No.	Coating	Grade	Dimensions			Dmax.	Tmax.	CT ±0.025
						d1	L1	L2			
10	60°	031401	I9MT1003CT060-NC2057	AlTiN+TiSiN	P35	2	0.58	7.5	10	7.5	12.35
	90°	031402	I9MT1003CT090-NC2057					4.6	10	4.6	
	120°	031403	I9MT1003CT120-NC2057					-	-	2.9	

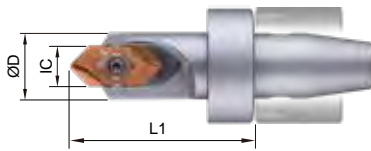

► Basic Holder >>

- G6.3 / 10,000 r.p.m.
- With internal coolant.

IC	Code	Parts No.	Basic Holder	L1	øD	Screw	Key
10	16-801003	00-99816-IC10BH		16	45	*S-25060 / 0.9Nm	NK-T7

*Torque screwdriver is recommended.

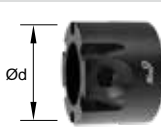
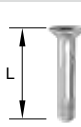
► Accessories - Set & Spare >>

Set		Ergo Nut				High Strength Ergo Pin			L-Key	Ergo Spanner
										
ER	Parts No.	Parts No.	Ød	Pitch	Torque	Parts No.	L	Torque	Parts No.	Parts No.
ER16	00-99816-M19S	00-99816-M19	25	M19xP1.0	30 Nm	NS-50025	25	5 Nm	NK-LW3	00-99816-SP28
	00-99816-M22S	00-99816-M22	28	M22xP1.5	30 Nm	NS-50028	28	5 Nm		

5

Ergo

i-Center Cutting Data

- Internal coolant is recommended.
- Middle value of feed rate is recommended for starting.
- Using your “d1” value and cutting speed Vc from the data sheet, calculate spindle speed “S”(r.p.m).
- “ F” feed rate per minute $F = S \times f = \text{IPR} \times \text{r.p.m.}$

► Indexable Center Drill >>

Workpiece Material	Vc (m/min.)		d1 (Pilot Diameter)									
			Ø1	Ø1.25	Ø1.50	Ø1.60	Ø2.0	Ø2.50	Ø3.0	Ø3.15		
P Carbon steel C<0.3%	< 80	S r.p.m.	2000	2000	1800	1600	1600	1400	1300	1200	●	○
		f mm/rev.	0.01	0.01	0.01	0.02	0.02	0.03	0.03	0.03		
	< 70	S r.p.m.	2000	2000	1800	1600	1600	1400	1300	1200	●	○
		f mm/rev.	0.01	0.01	0.01	0.02	0.02	0.03	0.03	0.03		
Low alloy steel C<0.3%	< 65	S r.p.m.	2000	2000	1800	1600	1600	1400	1300	1200	●	○
		f mm/rev.	0.01	0.01	0.01	0.01	0.01	0.02	0.02	0.03		
High alloy steel C>0.3%	< 60	S r.p.m.	1000	1000	900	800	800	700	600	600	●	○
		f mm/rev.	0.01	0.01	0.01	0.01	0.01	0.02	0.02	0.03		
M Stainless steel	< 20	S r.p.m.	1000	1000	900	800	800	700	600	600	●	○
		f mm/rev.	0.003	0.005	0.005	0.005	0.01	0.01	0.01	0.02		
N Al, and non-ferrous metal	< 200	S r.p.m.	6000	6000	5000	4800	4800	4200	4000	3600	●	○
		f mm/rev.	0.01	0.01	0.01	0.01	0.01	0.02	0.02	0.02		

● Best ○ Possible

5
Ergo

► Spotting & Countersink >>

Workpiece Material	Spotting				Countersink	
	Vc (m/min)	f (mm/rev.)			Vc (m/min)	f (mm/rev.)
		60°	90°	120°		
P Carbon steel C<0.3%	120 ~ 250	0.08 ~ 0.20	0.15 ~ 0.25	0.10 ~ 0.30	120 ~ 250	0.20 ~ 0.50
Carbon steel C>0.3%	100 ~ 220	0.08 ~ 0.20	0.10 ~ 0.05	0.10 ~ 0.30	100 ~ 220	0.20 ~ 0.40
Low alloy steel C<0.3%	100 ~ 200	0.06 ~ 0.16	0.08 ~ 0.20	0.10 ~ 0.25	100 ~ 200	0.15 ~ 0.40
High alloy steel C>0.3%	80 ~ 180	0.06 ~ 0.12	0.08 ~ 0.20	0.10 ~ 0.25	80 ~ 180	0.10 ~ 0.30
M Stainless steel	60 ~ 120	0.04 ~ 0.10	0.06 ~ 0.12	0.08 ~ 0.15	60 ~ 120	0.08 ~ 0.30
N Al, and non-ferrous metal	150 ~ 300	0.08 ~ 0.20	0.10 ~ 0.25	0.10 ~ 0.30	150 ~ 300	0.20 ~ 0.50

X060 Micro Spotting & Engraving



► Micro Spotting >>

- Radius Angled Form

Angle	Code	Parts No.	Coating	Grade		Dimensions			Wmin.	Wmax.	Tmax.	
						L	S	Re				
90°	01X0082	X060A90W010R	NC2032	TiAlN	K20F		6	2.05	0.02	0.10	1.10	0.5
	01X0220		XP9001	Uncoated								
120°	01X0222	X060A120W010R	NC2032	TiAlN	K20F		6	2.05	0.02	0.10	2.53	0.7
142	01X0223	X060A142W010R	NC2032	TiAlN	K20F		6	2.05	0.02	0.10	2.42	0.4

► Engraving >>

- Radius Angled Form

Angle	Code	Parts No.	Coating	Grade		Dimensions			Wmin.	Wmax.	Tmax.	
						L	S	Re				
30°	01X0140	X060A30W020R	NC2032	TiAlN	K20F		6	2.05	0.04	0.20	0.52	0.6
	01X0142		XP9001	Uncoated								
45°	01X0021	X060A45W020R	NC2032	TiAlN	K20F		6	2.05	0.04	0.20	0.86	0.8
	01X0154		XP9001	Uncoated								
60°	01X0063	X060A60W020R	NC2032	TiAlN	K20F		6	2.05	0.04	0.20	1.36	1.0
	01X0166		XP9001	Uncoated								
90°	01X0207	X060A90W020R	NC2032	TiAlN	K20F		6	2.05	0.04	0.20	2.20	1.0
	01X0209		XP9001	Uncoated								

- Radius Form

Angle	Code	Parts No.	Coating	Grade		Dimensions			Wmin.	Wmax.	Tmax.	
						L	S	Re				
30°	01X0119	X060A30R020	NC2032	TiAlN	K20F		6	2.05	0.2	0.15	0.63	0.6
	01X0134		XP9001	Uncoated								
45°	01X0013	X060A45R020	NC2032	TiAlN	K20F		6	2.05	0.2	0.12	0.93	0.8
	01X0150		XP9001	Uncoated								
60°	01X0117	X060A60R020	NC2032	TiAlN	K20F		6	2.05	0.2	0.10	1.39	1.0
	01X0159		XP9001	Uncoated								

► More & Cutting Data >>

- For more micro spotting insert & cutting data, please refer to page 2-19.
- For more engraving insert & cutting data, please refer from page 3-65.

X060 Deburring



► Deburring >>

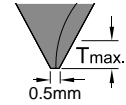

Angle	Code	Part No.	Coating	Grade	Flutes		Dimensions		Tmin.	Tmax.
							L	S		
60°	01X611	X060A60T3-NC2032	TiAlN	K20F	3		6	2.8	0.1	0.9
	01X612	X060A60T3-XP9001	Uncoated							
90°	01X911	X060A90T3-NC2032	TiAlN	K20F	3		6	2.8	0.1	0.9
	01X912	X060A90T3-XP9001	Uncoated							
60°	01X601	X060A60T6-NC2032	TiAlN	K20F	6		6	2.0	0.1	1.8
90°	01X901	X060A90T6-NC2032							0.5	1.5

► Basic Holder >>

- For entire X060 engraving, spotting and deburring inserts.
- G4.0 / 20,000 r.p.m.

Code	Parts No.	Basic Holder	L1	Screw	Key
16-69X004	00-99816-X060		22	*NS-22044 0.9Nm	NK-T7

*Torque screwdriver is recommended.

► Accessories - Set & Spare >>

Set		Ergo Nut				High Strength Ergo Pin			L-Key	Ergo Spanner
	* Nut, pin & L-key are included.		Ød			L				
ER	Parts No.	Parts No.	Ød	Pitch	Torque	Parts No.	L	Torque	Parts No.	Parts No.
ER16	00-99816-M19S	00-99816-M19	25	M19xP1.0	30 Nm	NS-50025	25	5 Nm	NK-LW3	00-99816-SP28
	00-99816-M22S	00-99816-M22	28	M22xP1.5	30 Nm	NS-50028	28	5 Nm		

► Cutting Data >>

- For Deburring, please refer to page 4-79.

Multi-Functional Tool Spotting & Chamfering



► Inserts >>

Angle	Code	Parts No.	Coating	Grade		Dimensions			Dmax.	Tmax.
						L	S	Re		
60°	0106001	V06006T1W06-NC2071	TiN	K20F		6.35	2.0	0.2	2.7	2.0
	0106002	V06006T1W06-NC2032	TiAlN							
	0106004	V06006T1W06-NC9031	TiN							
90°	013401	N9MT080208CT-NC40	TiN	K20F		8.31	2.38	0.8	10	4.5
	013402	N9MT080204CT-NC40	TiN					0.4		
	013403	N9MT080204CT-NC10	TiAlN					0.4		
90°	014401	N9MT11T3CT-NC40	TiN	P35		11.11	3.97	0.8	14	7
	014402	N9MT11T3CT-NC10	TiAlN					K10F		

► Basic Holder >>

- G6.3 / 10,000 r.p.m.

Code	Parts No.	Basic Holder	Insert Type	L1	Screw	Key
16-692005	00-99816-V060		V060...		*NS-22044 0.9Nm	NK-T7
16-603004	00-99816-610		N9MT0802...	22	NS-30055 2.0 Nm	NK-T8
16-604010	00-99816-614		N9MT11T3...		NS-35080 2.5 Nm	NK-T15

*Torque screwdriver is recommended.

► Accessories - Set & Spare >>

Set		Ergo Nut				High Strength Ergo Pin			L-Key	Ergo Spanner
	* Nut, pin & L-key are included.									
ER	Parts No.	Parts No.	Ød	Pitch	Torque	Parts No.	L	Torque	Parts No.	Parts No.
ER16	00-99816-M19S	00-99816-M19	25	M19xP1.0	30 Nm	NS-50025	25	5 Nm	NK-LW3	00-99816-SP28
	00-99816-M22S	00-99816-M22	28	M22xP1.5	30 Nm	NS-50028	28	5 Nm		

► Cutting Data >> please refer to page 3-76 for 60° insert, page 2-45 for 90° insert.

45° Chamfer Mill



► Inserts >>

Code	Parts No.	Coating	Grade		Dimensions			
					L	S	Re	
021401	N9GX04T002	NC2032	AlTiN	K20F		4.0	1.8	0.2
021402		NC9071	TiN					

► Basic Holder >>

- For front and back chamfering.
- G6.3 / 10,000 r.p.m.

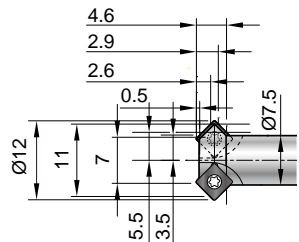
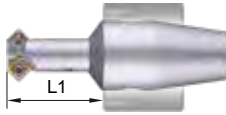

Code	Parts No.	Basic Holder	L1	No. of teeth	Screw	Key
16-701003	00-99816-C10			22	2	*NS-18037 NK-T6 0.6Nm

*Torque screwdriver is recommended.

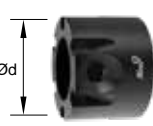
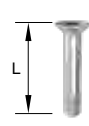

Ergo

► Accessories - Set & Spare >>

Set		Ergo Nut				High Strength Ergo Pin			L-Key	Ergo Spanner
	* Nut, pin & L-key are included.		Ød				L			
ER	Parts No.	Parts No.	Ød	Pitch	Torque	Parts No.	L	Torque	Parts No.	Parts No.
ER16	00-99816-M19S	00-99816-M19	25	M19xP1.0	30 Nm	NS-50025	25	5 Nm	NK-LW3	00-99816-SP28
	00-99816-M22S	00-99816-M22	28	M22xP1.5	30 Nm	NS-50028	28	5 Nm		

► Cutting Data >> please refer to page 4-89.

Power Mill



▶ Inserts >>

- U type insert is fully ground for reducing the cutting resistance during the cutting, best choice for long shank cutter.
- H type with high positive rake angle, shape edge.

Code	Parts No.		Coating	Grade	Insert	Dimensions				
						Re	Ap	L	W	S
05A122	A9GT060201H	NC2033	TiAlN	K20F		0.1	5	6.5	4	2.45
05A123		NC9031	TiN							
05A132	A9GT060202H	NC2033	TiAlN	K20F		0.2				
05A133		NC9031	TiN							
05A102	A9GT060205H	NC2033	TiAlN	K20F		0.5				
05A103		NC9031	TiN							
05A142	A9GT060201U	NC2032	TiAlN	K20F		0.1				
05A143	A9GT060202U	NC2032	TiAlN	K20F		0.2				
05A144	A9GT060205U	NC2032	TiAlN	K20F		0.5				

▶ Basic Holder >>

- G6.3 / 10,000 r.p.m.
- Customized cutter is available on request. Please refer to page 5-107.

ER Taper	Code	Parts No.	ØD	Basic Holder	L1	No. of teeth	α°	Screw / Key	
ER11	11-51A100	00-99811-10A06	10		14	2	5	*NS-18037 0.6Nm / NK-T6	
	11-51A122	00-99811-12A06	12			2	4		
ER16 <small>(with internal coolant)</small>	16-51A100	00-99816-10A06	10			14.5	2		5
	16-51A122	00-99816-12A06	12				2		4
	16-51A130	00-99816-16A06	16	3			2		
	16-51A140	00-99816-20A06	20	3			2		
	16-51A150	00-99816-25A06	25	4			1.3		
	16-51A160	00-99816-32A06	32	4			1		
ER20	20-51A122	00-99820-12A06	12		26	2	4		
	20-51A130	00-99820-16A06	16			3	2		
	20-51A140	00-99820-20A06	20			3	2		
	20-51A150	00-99820-25A06	25			4	1.3		
ER16	16-51A101	00-99816-10A06-32L	10		32	2	5		
	16-51A102	00-99816-10A06-40L	10			2	5		
ER20	20-51A101	00-99820-10A06-40L	10		40	2	5		
	20-51A124	00-99820-12A06-40L	12			2	4		

*Torque screwdriver is recommended.

5

Ergo

► Accessories - Set & Spare >>

Set		Ergo Nut				High Strength Ergo Pin			L-Key	Ergo Spanner
ER	Parts No.	Parts No.	Ød	Pitch	Torque	Parts No.	L	Torque	Parts No.	Parts No.
ER11	00-99811-M13S	00-99811-M13	19	M13xP0.75	12 Nm	NS-40019	19	3 Nm	NK-LW25	00-99811-SP20
ER16	00-99816-M19S	00-99816-M19	25	M19xP1.0	30 Nm	NS-50025	25	5 Nm	NK-LW3	00-99816-SP28
	00-99816-M22S	00-99816-M22	28	M22xP1.5	30 Nm	NS-50028	28	5 Nm		
ER20	00-99820-M24S	00-99820-M24	34	M24xP1.0	45 Nm	NS-60033	33	6 Nm	NK-LW4	00-99820-SP36
	00-99820-M25S	00-99820-M25	34	M25xP1.5	45 Nm	NS-60033	33	6 Nm		

► Cutting Data >>

Workpiece Material	Vc (m/min)	fz (mm/tooth)			Grade of insert	
Carbon Steel	80 ~ 150	0.03 ~ 0.07	1.5	3	1	
P Low-alloy Steel C ≤ 0.3%						NC2033 NC2032
High-alloy Steel C > 0.3%	60 ~ 120	0.02 ~ 0.06	1.0	2.5	1	NC2033 NC2032
M Stainless Steel	60 ~ 120	0.01 ~ 0.05	0.5	2.0	1	NC2033
N Al, and non-ferrous metal (Cu)	200 ~ 500	0.02 ~ 0.07	2.0	4.0	2	NC9031 NC2032

► Performance >>

- Result - Surface Quality

Ergo power mill Ø10	Indexable milling cutter Ø10	Carbide end mill Ø10
VB=0.04 mm No chipping 😊	VB=0.04 mm Partial chipping 😞	VB=0.20 mm Extensive chipping 😞

- Measure VB value (tool wearing) and chipping condition

Surface finishing is fine 😊	About 50% surface finishing is rough 😞	About 80% surface finishing is rough 😞

5

Ergo

Ergo Setter TP



▶ Quick and simple tool length setting >>

▶ Tool length setter >>

- Ergo setter is an easy tool length recorder while setting the tool length on swiss type automatic lathe and CNC turning centers.
- Reduce machine downtime, prevent insert and workpiece from damage.

Code	Parts No.	Illustration	L-Key
16-TP0001	00-99816-TP		NK-LW15 (2 Nm)

▶ Accessories - Set & Spare >>

Set		Ergo Nut				High Strength Ergo Pin			L-Key	Ergo Spanner
	* Nut, pin & L-key are included.									
ER	Parts No.	Parts No.	Ød	Pitch	Torque	Parts No.	L	Torque	Parts No.	Parts No.
ER16	00-99816-M19S	00-99816-M19	25	M19xP1.0	30 Nm	NS-50025	25	5 Nm	NK-LW3	00-99816-SP28
	00-99816-M22S	00-99816-M22	28	M22xP1.5	30 Nm	NS-50028	28	5 Nm		

▶ Setting process >>

• Step-1

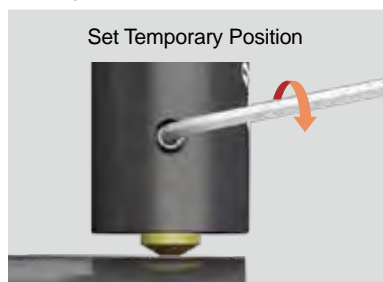

- 1-1: Move the setter tip to touch the center-top of workpiece.
- 1-2: Press spring pin 1~2 mm down.
- 1-3: Tighten screw to fix spring pin, and get a temporary length of setter.
- 1-4: Input the temporary length value to the CNC controller.

• Step-2

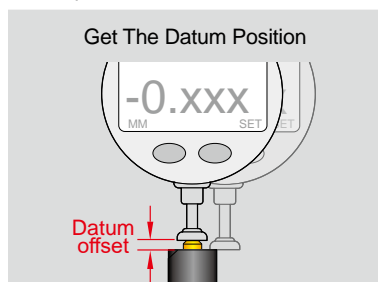

- 2-1: The offline measures the datum offset of setter by height gauge.
- 2-2: Input datum offset to CNC controller.

• Step-3

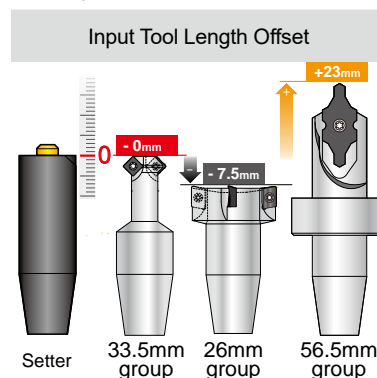

- 3-1: Choose an Ergo tool to install, and input the offset value to CNC controller directly.

Assembly Steps

! Make sure all parts are clean while re-assembly or change tool

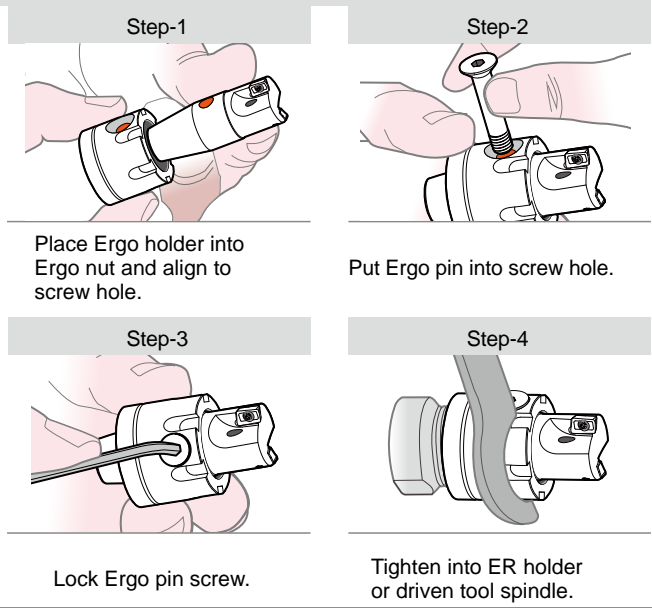
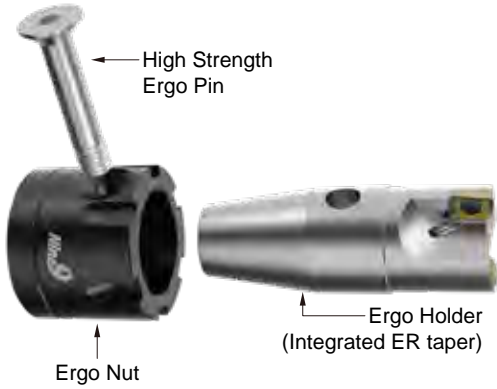

► As long as it complies with ER11, 16, 20 and ER25 standard, you can use Ergo system. >>



- Quick change and ultrashort over all tool length.
- Apply on any kinds of driven tools and collet chucks.

5

Ergo

► Performance >>

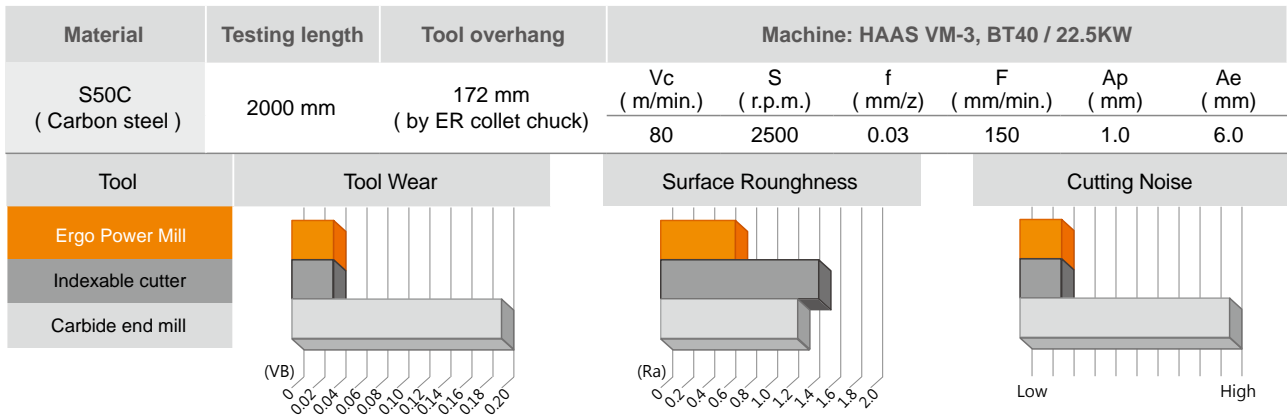

Ergo Sets For your first ordering

► The insert is not included >>

Nut	Series	Code	Parts No.	Contents
With ER16 Mini Nut (M19 x 1.0 P)	i-Center	161-801003	00-99816-IC10BH-M19S	 <p>Ergo Holder x1 Ergo ER16 Mini Nut x1 High Strength Ergo pin x1 3mm L key x1 Insert Key x1</p> <p>* The insert is not included.</p>
	X060 - Micro Spotting, Engraving & Deburring	161-69X004	00-99816-X060-M19S	
	Multi-Functional Tool - Spotting & Chamfering	161-692005	00-99816-V060-M19S	
		161-603004	00-99816-610-M19S	
		161-604010	00-99816-614-M19S	
	Chamfer Mills	161-701003	00-99816-C10-M19S	
		Power Mills	161-51A100	
	161-51A122		00-99816-12A06-M19S	
	161-51A130		00-99816-16A06-M19S	
	161-51A140		00-99816-20A06-M19S	
	161-51A150		00-99816-25A06-M19S	
	161-51A160		00-99816-32A06-M19S	
	Tool Length Setter	161-TP0001	00-99816-TP-M19S	
	With ER16 Nut (M22 x 1.5 P)	i-Center	162-801003	
X060 - Micro Spotting, Engraving & Deburring		162-69X004	00-99816-X060-M22S	
Multi-Functional Tool - Spotting & Chamfering		162-692005	00-99816-V060-M22S	
		162-603004	00-99816-610-M22S	
		162-604010	00-99816-614-M22S	
Chamfer Mills		162-701003	00-99816-C10-M22S	
		Power Mills	162-51A100	00-99816-10A06-M22S
162-51A122			00-99816-12A06-M22S	
162-51A130			00-99816-16A06-M22S	
162-51A140			00-99816-20A06-M22S	
162-51A150			00-99816-25A06-M22S	
162-51A160			00-99816-32A06-M22S	
Tool Length Setter		162-TP0001	00-99816-TP-M22S	

5

Ergo

Enquiry Form

► **Company >>**

► **Challenge or improvement >>**

• The following information should be checked while discussing with customer.

Machine		Current tool	
Machine Type		Cutting Speed	<input type="checkbox"/> HSS
Spindle Speed	Max. r.p.m.		<input type="checkbox"/> Solid Carbide
Power of Spindle motor	<input type="checkbox"/> KW <input type="checkbox"/> HP		m/min. SFM
Coolant supply	<input type="checkbox"/> NO	Others	
	<input type="checkbox"/> If yes, <input type="checkbox"/> External <input type="checkbox"/> Internal		bar(psi)
Workpiece Material		Feed Rate	mm/rev. inch/rev.

► **ER Taper-shank dimensions >>**

• MOQ: 2 pcs / Lead Time: 10 ~ 12 Weeks.

Style		
<input type="checkbox"/> A	<input type="checkbox"/> B	<input type="checkbox"/> C

Cutter Dia. : ($\varnothing D_c$)		
L1 : (See chart for Max.)	θ : E :	
Internal Coolant	<input type="checkbox"/> Yes <input type="checkbox"/> No	
ER Nut	<input type="checkbox"/> N9ER16-M19 <input type="checkbox"/> N9ER16-M22 <input type="checkbox"/> N9ER20-M24 <input type="checkbox"/> N9ER20-M25 <input type="checkbox"/> N9ER25-M32	
Nut Specifications	M	
	<input type="checkbox"/> ER16	M19xP1.0
	<input type="checkbox"/> ER16	M22xP1.5
	<input type="checkbox"/> ER20	M24xP1.0
	<input type="checkbox"/> ER20	M25xP1.5
<input type="checkbox"/> ER25	M32xP1.5	

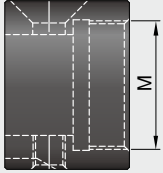
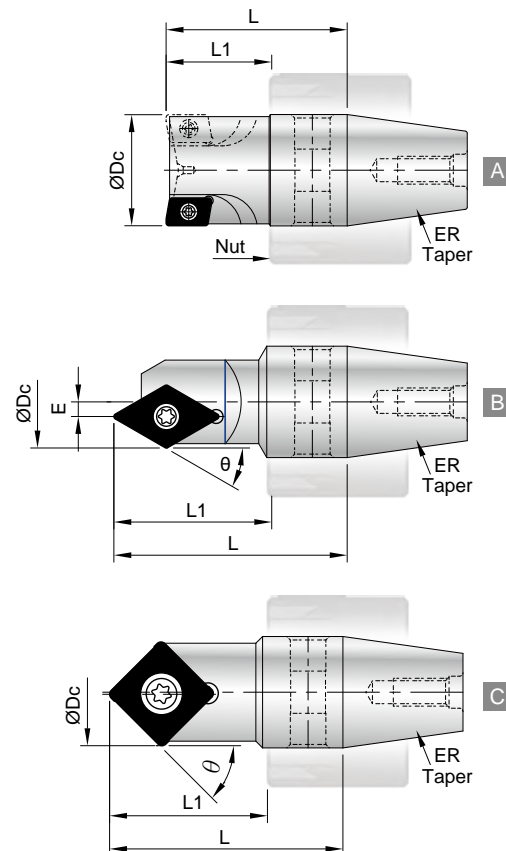
ER Taper Specifications			
$\varnothing D_c$	L1 Max.	L Max.	ER Taper
10 ~ 32	22	34	ER16
	26.5	40	ER20
	30.5	50	ER25

5

Ergo



NC Helix Drill >>>

The Expert Of Swarfs Control

P M K N S H

▶ **Two Types Of Shank, Drilling Depth Up To 8xDc**

- Cylindrical shank - Apply external coolant.
- Patented screw fit -With center coolant hole.

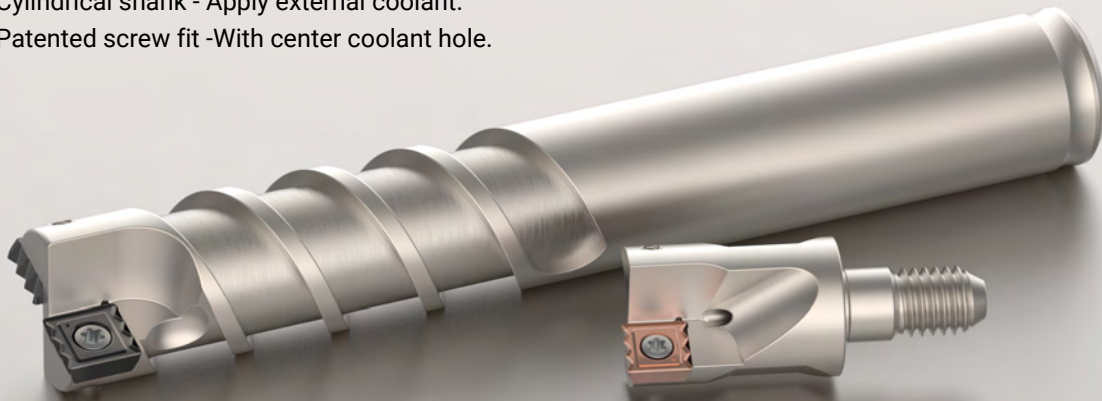

Features >>>

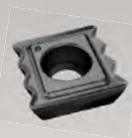

▶ **Serrated Cutting Edge.**

- One insert is able to cut different materials.
- Special insert geometry is able to cut different materials and eliminate swarf and vibration problems while drilling difficult material or deeper holes. Excellent swarfs control for providing safe and smooth chip removal for modern automation.
- 2 cutting edges insert

▶ **Only Six Tools For Making Ø13~Ø65mm Holes From Solid.**

- Saving your tool inventory and cost!
- No need to peck drill or dwell in operation even machine without internal coolant.

▶ **20° Ramping Angle, Either Linear Or Circular Ramping.**

- Cuts material by helical interpolation, maximum ramping angle is 20°.

▶ **Low Spindle Power Is Required, Easy To Cut, Not Only A Drill, But An End Mill Too.**



Applications

All NC Helix Drill ▶
must be programmed by
helical interpolation

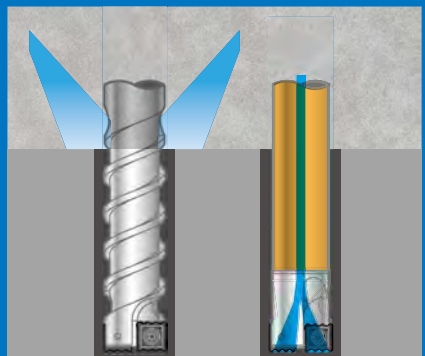

Two types of shank

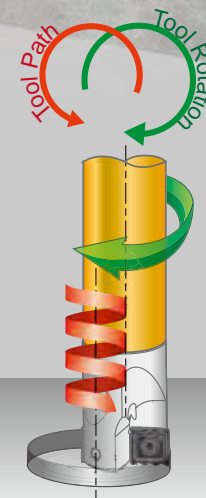

“

- One tool performs multiple applications.
- Rough Milling, Drilling & Slotting.
- Excellent swarf removal. ”



Short & small chips

6

NC Helix Drill

NC Helix Drill Features

▶ Reduce your tool inventory >> Low Cost! Economy!

- Each holder can machine different diameters and hole depths, saving your tool inventory and cost!
- No need to peck drill or dwell in operation even machine without internal coolant.



▶ Lower spindle power consumption >> Easy to cut!

- Thanks to the small cutting load of the serrated cutting edge and helical interpolation lower power consumption. Work quicker, smarter and achieve better results.
- Circular ramping milling, maximum ramping angle is 20°.
- For example: tool HD27 machining Ø50 mm hole, 9 mm pitch for aluminum, 6 mm pitch for carbon steel.

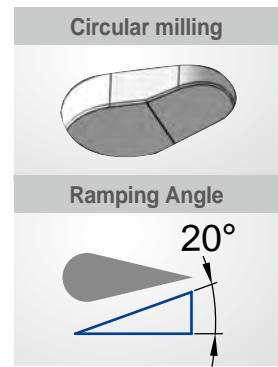

▶ Just six tools for drilling Ø13~ Ø 65 mm or larger >>



- Cuts by helical interpolation.
- Each holder can machine different diameters and hole depths.
- Enlarger hole is adaptable by using 99323 internal coolant cutter.

▶ Special insert geometry >> exceptional swarfs control.

- Serrated cutting edge makes the chips short and small, and easier to evacuate.
- Eliminate swarf and vibration problems while drilling difficult material or deeper holes.
- Excellent swarfs control for providing safe and rational chip removal for modern automation.



► **Functions in variable conditions >>**
It's so easy!



► **Roughness Measuring >>**

- Making a flatness at bottom just by NC program, easy and smart!

Workpiece Application



Make "One more turn" after reached the depth.
 Ex :
 :
 G03 I-1.5 Z-30 P5
 G03 I-1.5 <make one more turn >
 G01 X0 Y0 < afterward, let tool back to center of hole >

Perthometer M1	
Object Name	
#	
Lt	5.600 mm
Ls Standard	2.5 μm
Lc	0.000 mm
Ra	1.476 μm
Rz	6.91 μm
Rmax	7.71 μm
RPc(0.5,-0.5)	48 /c
R Profile	
Lc	0.000 mm
VER	2.50 μm

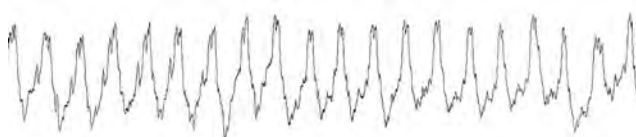

► **One tool performs multiple applications >>**

Not only a drill, but an end mill tool. Small path radius to cut hole, step hole, various shape of cavity on different material.

Less inventory of different sizes of drills and indexable end mills.

Replace your end mill by NC Helix Drill. Make the impossible become possible!



NC Helix Drill

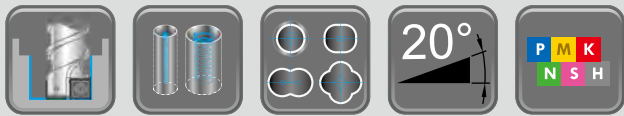

▶ Inserts >>

- NC5072** : • P40, TiAlN coating. General purpose, suitable for almost all kind of steel, stainless steel and Titanium.
 • Recommended while clamping devices is unstable or deep hole drilling or apply on low power machines.
- NC2032** : • K20F, TiAlN coating.
 • Design for high performance cutting, special good for cast iron and hardened material <HRC50°.

Code	Parts No.	Grade	Coating		Dimensions			Screw	Key
					L	S	Re		
041021	01-N9MX04T002	NC5072	P40	TiAlN	4.75	1.8	0.2	*NS-18037 0.6Nm	NK-T6
041001		NC2032	K20F						
042021	01-N9MX05T103	NC5072	P40	TiAlN	5.75	2.0	0.3	*NS-20045 0.6Nm	NK-T6
042001		NC2032	K20F						
043021	01-N9MX070204	NC5072	P40	TiAlN	7.5	2.4	0.4	*NS-25045 0.9Nm	NK-T7
043001		NC2032	K20F						
044021	01-N9MX100306	NC5072	P40	TiAlN	10.0	3.18	0.6	NS-30072 2.0Nm	NK-T9
044001		NC2032	K20F						
045021	01-N9MX12T308	NC5072	P40	TiAlN	12.5	3.97	0.8	NS-35080 2.5Nm	NK-T15
045001		NC2032	K20F						

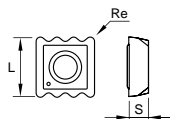

*Torque screwdriver is recommended.

▶ Cylindrical Shank >>

- Made from hardened high alloy steel 48 HRC.
- Unique helical groove design generates chip-removing coolant stream.
- Designed for CNC machine with external coolant.

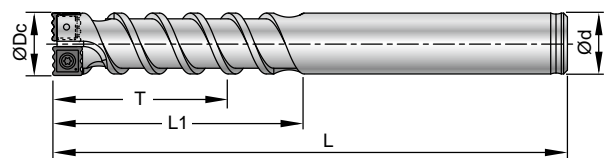

Code	Parts No.	Type	Capable of drill dia. mm		ØDc	T	L1	L	Ød	Insert type	Max. ramping angle
			Dmin.	Dmax.							
401001	00-99321-010-1320	BC10-HD11-1320	13	20	11	30	40	80	10	N9MX04T002	20°
402001	00-99321-012-1525	BC12-HD13-1525	15	25	13	36	50	100	12	N9MX05T103	20°
403001	00-99321-016-2030	BC16-HD17-2030	20	30	17	50	60	110	16	N9MX070204	20°
404001	00-99321-020-2540	BC20-HD22-2540	25	40	22	60	70	125	20	N9MX100306	20°
405001	00-99321-025-3050	BC25-HD27-3050	30	50	27	75	85	165	25	N9MX12T308	20°

▶ Side Lock Shank >>

- Made from hardened high alloy steel 48 HRC.
- With internal coolant
- Special size is available on request.

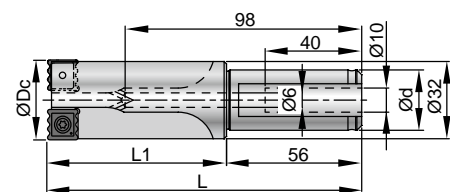

Code	Parts No.	Type	Capable of drill dia. mm		ØDc	L	L1	Ød	Max. Depth	Insert type	Max. ramping angle
			Dmin.	Dmax.							
405002	00-99321-025-4265	SL25-HD33-4265	42	65	33	130	74	25	50	N9MX12T308	9°

► Screw Fit Cutter >>

- Made from hardened high alloy steel 42 HRC.
- With internal coolant.
- Standard screw-fit body adapts to almost any kinds of the screw-fit tool holder or extension bar in the market.
- Possible to apply for enlarge hole.

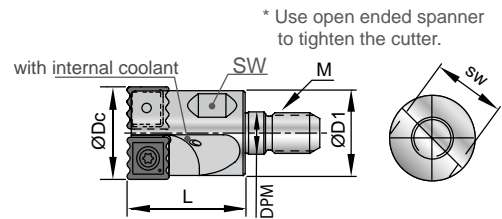

Code	Part No.	Type	Capable of drill dia. mm		ØDc	L	M	DPM	Ød1	SW	Insert type	Max. ramping angle
			Dmin.	Dmax.								
421001	00-99323-010-1320	M05-HD11-1320	13	20	11	20	M5	5.5	10	8	N9MX04T002	20°
422001	00-99323-012-1525	M06-HD13-1525	15	25	13	25	M6	6.5	12	10	N9MX05T103	20°
423001	00-99323-016-2030	M08-HD17-2030	20	30	17	25	M8	8.5	16	14	N9MX070204	20°
424001	00-99323-020-2540	M10-HD22-2540	25	40	22	30	M10	10.5	20	18	N9MX100306	20°
425001	00-99323-025-3050	M12-HD27-3050	30	50	27	35	M12	12.5	25	23	N9MX12T308	20°

* Special size is available by request.

Extension Bar

► Steel Type >>

- T is the maximum overhang length.
- With internal coolant hole.

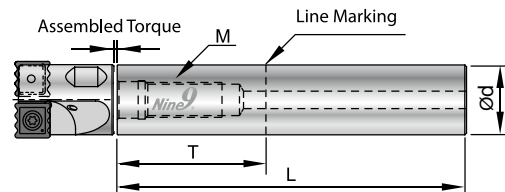

Code	Parts No.	Type	Ød	T	L	M	Assembled Torque
970100	00-99801-10S	BC10-075M05S	10	25	75	M5xP0.8	6.5 Nm
970122	00-99801-12S	BC12-075M06S	12	25	75	M6xP1.0	11.0 Nm
970161	00-99801-16S	BC16-090M08S	16	35	90	M8xP1.25	25.0 Nm
970202	00-99801-20S	BC20-100M10S	20	40	100	M10xP1.5	50.0 Nm
970253	00-99801-25S	BC25-120M12S	25	50	120	M12xP1.75	60.0 Nm

► Solid Carbide Type >>

- T is the maximum overhang length.
- With internal coolant hole.

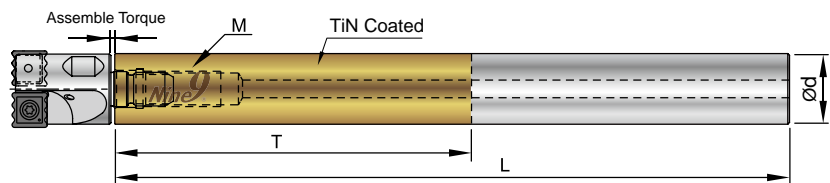

Code	Parts No.	Type	Ød	T	L	M	Assembled Torque
980102	00-99801-10W	BC10-100M05W	10	50	100	M5xP0.8	6.5Nm
980122	00-99801-12W	BC12-100M06W	12	60	100	M6xP1.0	11.0Nm
980143	00-99801-14W	BC14-120M08W	14	70	120	M8xP1.25	25.0Nm
980164	00-99801-16W	BC16-150M08W	16	80	150	M8xP1.25	25.0Nm
980184	00-99801-18W	BC18-150M10W	18	90	150	M10xP1.5	50.0Nm
980205	00-99801-20W	BC20-200M10W	20	100	200	M10xP1.5	50.0Nm
980255	00-99801-25W	BC25-200M12W	25	125	200	M12xP1.75	60.0Nm

Technical Guide

► Programming conditions

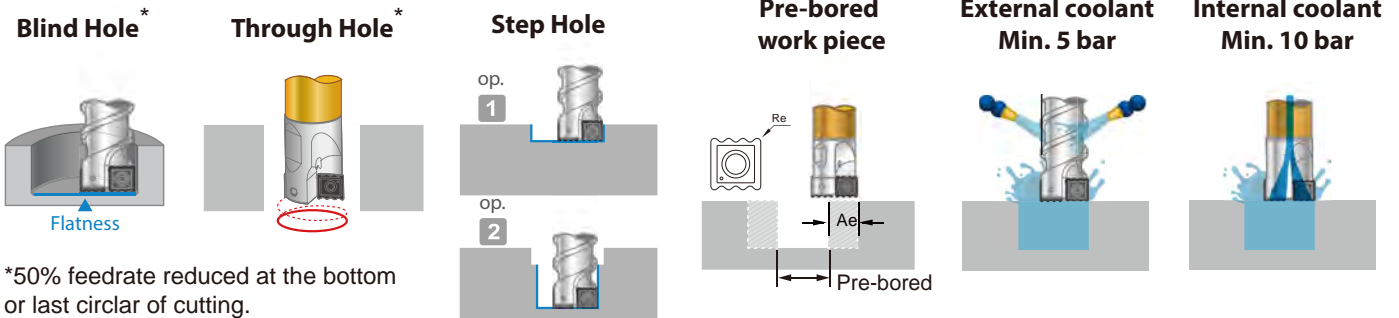

► For enlarge hole

Minimum and Maximum Ae for programming a pre-bored hole

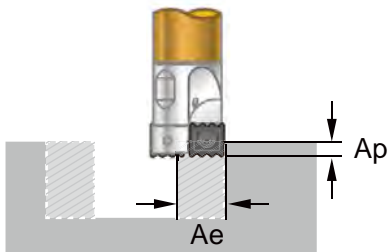

Max. Ae = Dc - (Rex2)
 Min. Ae = 1/3 insert length (L)
 Max. ap < 3/4 of insert length

Insert type	Re	Min. Ae	Max. Ae	Max. Ap
N9MX04T002	0.2	1.6	10.6	3.5
N9MX05T103	0.3	2.0	12.4	4.3
N9MX070204	0.4	2.5	16.2	5.6
N9MX100306	0.6	3.3	20.8	7.5
N9MX12T308	0.8	4.2	25.4	9
N9MX12T308*	0.8	4.2	31.4*	9

(* for 99321-025-4265)

NC Helix Drill	Cutting Parameters (S & F)	Formula
	$S = \frac{Vc \times 1000}{Dc \times \pi} \text{ r.p.m.}$	Dc = Dia. of drill mm
	$F = S \times fz \times Z \text{ mm/min.}$	D = Dia. of hole mm
	$d = D - Dc \text{ mm}$	L = Depth of drilling mm
	$I = \frac{(D-Dc)}{2} \text{ mm}$	Vc = Cutting speed m/min.
	Cutting time (T)	S = Spindle speed r.p.m.
	$T = \frac{\pi \times d \times L \times 60}{F \times P} \text{ sec.}$	I = Circular radius mm
	Chip removal Volume rate (Q)	fz = Feed rate mm/tooth
	$Q = \frac{\pi \times D^2 \times L \times 60}{4 \times 1000 \times T} \text{ cm}^3 / \text{min.}$	F = Table feed rate mm/min.
		d = Circular diameter (D-Dc) mm
		P = Pitch of helical interpolation mm
	T = Cutting time sec.	
	Q = Chip removal volume rate cm ³ / min.	
	Z = Insert tooth	

► Spindle power

The Feed rate(Fc) may be adjusted by the power factor(PF) of below:

$$F_c = F \times PF \text{ (mm/min.)}$$

Spindle Type	BT-30 Small power			BT-40 Medium power			BT-50 Big power		
	< 5	7	10	12	16	20	22	25	> 30
Spindle Power (KW)	0.8	0.85	0.9	0.95	1	1.05	1.1	1.15	1.2
Power Factor (PF)	Lower pitch			Medium pitch			Large pitch		

Remarks:

Fc: Adjusted Feed rate for real cutting

Pitch(P) can be selected according to spindle power.

► 99323 screw fit cutter assembly

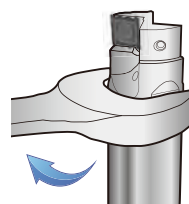

To ensure a secure fit, use a spanner to tighten the cutter until there is no gaps visible.

Part No.	Assembled Torque
99323-010-1320	6.5 Nm
99323-012-1525	11.0 Nm
99323-016-2030	25.0 Nm
99323-020-2540	50.0 Nm
99323-025-3050	60.0 Nm

► Apply only helical interpolation or ramping down feed only!

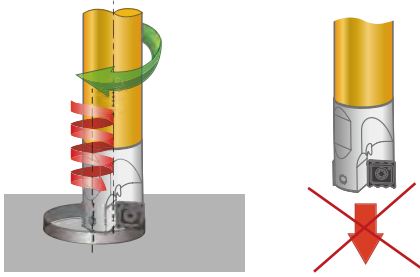

Step 1: Choose Cutting speed(Vc), feed rate(f) and Pitch(P) on the cutting data tables (page 3&4). The feed rate and Pitch can be adjusted depend on the spindle power, please see page 6-114.

Step 2: Decide circular radius I ($I = (D-D_c)/2$)
For enlarge hole, decided Ae as page 6-114.

Step 3: Programming helical interpolation program according to CNC controller.

This sample program is written for general condition of the CNC controller. The NC program can be generated by most of the CAD/CAM system.

► Example

1 Programming a blind hole

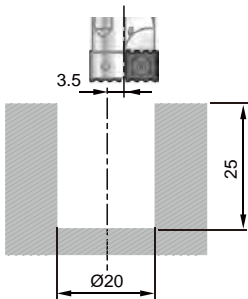

Material	N AL6061T6
Holder	00-99321-012-1525
Insert	01-N9MTX05T103-NC5072
Dc	ø13 mm
Vc	306 m/min.
f	0.065 mm/tooth
P	3 mm
I	$(20-13)/2 = 3.5$ mm

G00 G90 X3.5 Y0.
S7500 M03
G43 H01 Z30. M08
Z5.
G01 Z2. F500.
G03 I-3.5 Z-1. F975
G03 I-3.5 Z-4.
G03 I-3.5 Z-7.
G03 I-3.5 Z-10.
G03 I-3.5 Z-13.
G03 I-3.5 Z-16.
G03 I-3.5 Z-19.
G03 I-3.5 Z-22.
G03 I-3.5 Z-25.
G03 I-3.5 F500.
G01 X0. Y0.
G00 G90 Z5. M09
G00 G90 Z30. M05
G28 G91 Z0.

2 Programming a step hole

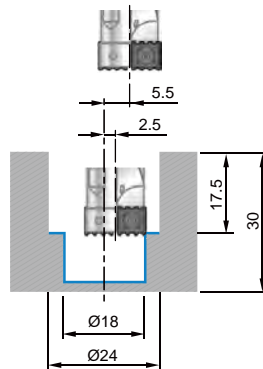

Material	P SCM440
Tool holder	00-99323-012-1525
Insert	01-N9MTX05T103-NC5072
Dc	ø13 mm
Vc	100 m/min.
For D1	ø24 mm
f1	0.07 mm/tooth
I1	$(24-13)/2 = 5.5$ mm
P1	2.4 mm
For D2	ø18 mm
f2	0.05 mm/tooth
I2	$(18-13)/2 = 2.5$ mm
P2	1.5 mm

G00 G90 X5.5 Y0. G03 I-2.5 Z-22.
S2450 M03 G03 I-2.5 Z-23.5
G43 H02 Z10. M08 G03 I-2.5 Z-25.
G01 Z1.7 F200. G03 I-2.5 Z-26.5
Z5. G03 I-2.5 Z-28.
G03 I-5.5 Z-0.7 F343. G03 I-2.5 Z29.5
G03 I-5.5 Z-3.1 G03 I-2.5 Z31.
G03 I-5.5 Z-5.5 G03 I-2.5 F150.
G03 I-5.5 Z-7.9 G01 X0. Y0.
G03 I-5.5 Z-10.3 G00 G90 Z5. M09
G03 I-5.5 Z-12.7 G00 G90 Z30. M05
G03 I-5.5 Z-15.1 G28 G91 Z0.
G03 I-5.5 Z-17.5
G03 I-5.5 F200.
G01 X2.5 Y0.
G03 I-2.5 Z-19. F245.
G03 I-2.5 Z-20.5

3 Programming a pre-bore hole

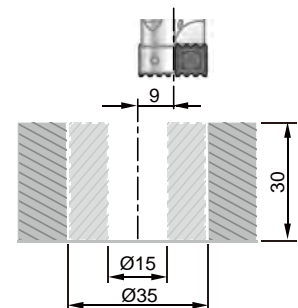

Material	K FCD400
Tool holder	00-99321-016-2030
Insert	01-N9MTX070204-NC5072
Prebore	15 mm
Dc	17 mm
Vc	90 m/min.
Pre-bored	ø15 mm
D	ø35 mm
f	0.1 mm/tooth
I	$(35-17)/2 = 9.0$ mm
P	4.0 mm

G00 G90 X9. Y0.
S1685 M03
G43 H03 Z30. M08
Z5.
G01 Z2. F200.
G03 I-9. Z-4. F337.
G03 I-9. Z-8.
G03 I-9. Z-12.
G03 I-9. Z-16.
G03 I-9. Z-20.
G03 I-9. Z-24.
G03 I-9. Z-28.
G03 I-9. Z-32.
G03 I-9. F200.
G01 X0. Y0.
G00 G90 Z5. M09
G00 G90 Z30. M05
G28 G91 Z0.

Cutting Data

Pitch Suggestion Table			
Spindle Power	< 12 KW	12-20 KW	> 20 KW
Pitch Pick Up	Lower Pitch	Medium Pitch	Higher Pitch

▶ 00-99321-010-1320 / 00-99323-010-1320 >>

Workpiece material	Vc m/min.		Ø13				Ø16				Ø20			
	99321	99323	fz mm/tooth	Pitch mm			fz mm/tooth	Pitch mm			fz mm/tooth	Pitch mm		
P Carbon steel 0.25%C 0.45% C 0.60%C Low alloy steel High alloy steel	120	200	0.025	0.60	0.80	1.00	0.055	0.90	1.20	1.50	0.08	1.20	1.60	2.00
	120	200	0.025	0.60	0.80	1.00	0.055	0.90	1.20	1.50	0.08	1.20	1.60	2.00
	100	150	0.025	0.60	0.75	0.90	0.05	0.80	1.10	1.35	0.07	1.00	1.40	1.80
	70	120	0.02	0.50	0.65	0.80	0.05	0.70	0.95	1.20	0.06	1.00	1.30	1.60
	60	90	0.02	0.50	0.65	0.80	0.05	0.70	0.95	1.20	0.06	1.00	1.30	1.60
M Stainless steel	60	90	0.02	0.50	0.65	0.80	0.05	0.70	0.95	1.20	0.06	1.00	1.30	1.60
K Cast iron	70	120	0.025	0.60	0.80	1.00	0.055	0.90	1.20	1.50	0.08	1.20	1.60	2.00
N Al Cu	345	500	0.025	0.90	1.20	1.50	0.055	1.30	1.80	2.25	0.08	1.80	2.40	3.00
	200	400	0.025	0.70	0.95	1.20	0.055	1.00	1.40	1.80	0.08	1.40	1.90	2.40
S Ni- alloy Titanium	20	28	0.01	0.50	0.65	0.80	0.015	0.70	0.95	1.20	0.03	0.90	1.30	1.60
	40	60	0.01	0.50	0.65	0.80	0.015	0.70	0.95	1.20	0.03	0.90	1.30	1.60
H Hardened	60	90	0.02	0.50	0.65	0.80	0.05	0.70	0.95	1.20	0.06	1.00	1.30	1.60

▶ 00-99321-012-1525 / 00-99323-012-1525 >>

Workpiece material	Vc m/min.		Ø15				Ø20				Ø25			
	99321	99323	fz mm/tooth	Pitch mm			fz mm/tooth	Pitch mm			fz mm/tooth	Pitch mm		
P Carbon steel 0.25%C 0.45% C 0.60%C Low alloy steel High alloy steel	120	200	0.035	1.20	1.60	2.00	0.065	1.50	2.00	2.50	0.09	1.80	2.40	3.00
	120	200	0.035	1.20	1.60	2.00	0.065	1.50	2.00	2.50	0.09	1.80	2.40	3.00
	100	150	0.03	1.10	1.50	1.80	0.06	1.30	1.78	2.25	0.08	1.60	2.15	2.70
	70	120	0.025	1.00	1.30	1.60	0.05	1.20	1.60	2.00	0.07	1.40	1.90	2.40
	60	90	0.025	1.00	1.30	1.60	0.05	1.20	1.60	2.00	0.07	1.40	1.90	2.40
M Stainless steel	60	90	0.025	1.00	1.30	1.60	0.05	1.20	1.60	2.00	0.07	1.40	1.90	2.40
K Cast iron	70	120	0.035	1.20	1.60	2.00	0.065	1.30	1.90	2.50	0.09	1.80	2.40	3.00
N Al Cu	345	500	0.035	1.80	2.00	2.20	0.065	2.20	2.98	3.75	0.09	2.70	3.60	4.30
	200	400	0.035	1.40	1.90	2.20	0.065	1.80	2.40	3.00	0.09	2.10	2.85	3.60
S Ni- alloy Titanium	20	28	0.0125	1.00	1.30	1.60	0.0225	1.20	1.60	2.00	0.03	1.40	1.90	2.40
	40	60	0.0125	1.00	1.30	1.60	0.0225	1.20	1.60	2.00	0.03	1.40	1.90	2.40
H Hardened	60	90	0.025	1.00	1.30	1.60	0.05	1.20	1.60	2.00	0.07	1.40	1.90	2.40

6

NC Helix Drill

Cutting Data

Pitch Suggestion Table			
Spindle Power	< 12 KW	12-20 KW	> 20 KW
Pitch Pick Up	Lower Pitch	Medium Pitch	Higher Pitch

▶ 00-99321-016-2030 / 00-99323-016-2030 >>

Workpiece material	Vc m/min.		Ø20			Ø25			Ø30					
	99321	99323	fz mm/tooth	Pitch mm		fz mm/tooth	Pitch mm		fz mm/tooth	Pitch mm				
P Carbon steel 0.25%C Carbon steel 0.45% C Carbon steel 0.60%C Low alloy steel High alloy steel	120	200	0.04	1.80	2.40	3.00	0.08	2.10	2.80	3.50	0.105	2.40	3.20	4.00
	120	200	0.04	1.80	2.40	3.00	0.08	2.10	2.80	3.50	0.105	2.40	3.20	4.00
	100	150	0.035	1.60	2.15	2.70	0.07	1.90	2.55	3.20	0.09	2.10	2.85	3.60
	70	120	0.03	1.40	1.90	2.40	0.065	1.60	2.20	2.80	0.08	1.90	2.55	3.20
	60	90	0.03	1.40	1.90	2.40	0.065	1.60	2.20	2.80	0.08	1.90	2.55	3.20
M Stainless steel	60	90	0.03	1.40	1.90	2.40	0.065	1.60	2.20	2.80	0.08	1.90	2.55	3.20
K Cast iron	70	120	0.04	1.80	2.40	3.00	0.08	2.10	2.80	3.50	0.105	2.40	3.20	4.00
N Al Cu	345	500	0.04	2.70	3.00	3.40	0.08	3.10	4.05	5.00	0.105	3.60	4.80	5.60
	200	400	0.04	2.10	2.85	3.40	0.08	2.50	3.35	4.20	0.105	2.80	3.80	4.80
S Ni- alloy Titanium	20	28	0.015	1.40	1.90	2.40	0.03	1.60	2.20	2.80	0.04	1.90	2.55	3.20
	40	60	0.015	1.40	1.90	2.40	0.03	1.60	2.20	2.80	0.04	1.90	2.55	3.20
H Hardened	60	90	0.03	1.40	1.90	2.40	0.065	1.60	2.20	2.80	0.08	1.90	2.55	3.20

▶ 00-99321-020-2540 / 00-99323-020-2540 >>

Workpiece material	Vc m/min.		Ø25			Ø32			Ø40					
	99321	99323	fz mm/tooth	Pitch mm		fz mm/tooth	Pitch mm		fz mm/tooth	Pitch mm				
P Carbon steel 0.25%C Carbon steel 0.45% C Carbon steel 0.60%C Low alloy steel High alloy steel	120	200	0.05	1.80	2.40	3.00	0.095	2.40	3.20	4.00	0.12	3.00	4.00	5.00
	120	200	0.05	1.80	2.40	3.00	0.095	2.40	3.20	4.00	0.12	3.00	4.00	5.00
	100	150	0.04	1.60	2.15	2.70	0.08	2.20	2.90	3.60	0.11	2.70	3.60	4.50
	70	120	0.035	1.40	1.90	2.40	0.07	1.90	2.55	3.20	0.095	2.40	3.20	4.00
	60	90	0.035	1.40	1.90	2.40	0.07	1.90	2.55	3.20	0.095	2.40	3.20	4.00
M Stainless steel	80	90	0.035	1.40	1.90	2.40	0.07	1.90	2.55	3.20	0.095	2.40	3.20	4.00
K Cast iron	70	120	0.05	1.80	2.40	3.00	0.095	2.40	3.20	4.00	0.12	3.00	4.00	5.00
N Al Cu	345	500	0.05	2.70	3.00	3.40	0.095	3.60	4.80	6.00	0.12	4.50	6.00	7.50
	200	400	0.05	2.10	2.85	3.40	0.095	2.90	3.85	4.80	0.12	3.60	4.80	6.00
S Ni- alloy Titanium	40	50	0.02	1.40	1.90	2.40	0.035	1.90	2.55	3.20	0.045	2.40	3.20	4.00
	80	90	0.02	1.40	1.90	2.40	0.035	1.90	2.55	3.20	0.045	2.40	3.20	4.00
H Hardened	80	90	0.035	1.40	1.90	2.40	0.07	1.90	2.55	3.20	0.095	2.40	3.20	4.00

Cutting Data

Pitch Suggestion Table			
Spindle Power	< 12 KW	12-20 KW	> 20 KW
Pitch Pick Up	Lower Pitch	Medium Pitch	Higher Pitch

▶ 00-99321-025-3050 / 00-99323-025-3050 >>

Workpiece material	Vc m/min.		Ø30			Ø40			Ø50						
	99321	99323	fz mm/tooth	Pitch mm		fz mm/tooth	Pitch mm		fz mm/tooth	Pitch mm					
P Carbon steel	0.25%C	120	200	0.055	2.40	3.00	3.40	0.12	3.00	4.00	5.00	0.135	3.60	4.80	6.00
	0.45% C	120	200	0.055	2.40	3.00	3.40	0.12	3.00	4.00	5.00	0.135	3.60	4.80	6.00
	0.60%C	100	150	0.05	2.20	2.90	3.40	0.10	2.70	3.60	4.50	0.12	3.20	4.30	5.40
	Low alloy steel	70	120	0.04	1.90	2.55	3.20	0.09	2.40	3.20	4.00	0.11	2.90	3.85	4.80
	High alloy steel	60	90	0.04	1.90	2.55	3.20	0.09	2.40	3.20	4.00	0.11	2.90	3.85	4.80
M Stainless steel	60	90	0.04	1.90	2.55	3.20	0.09	2.40	3.20	4.00	0.11	2.90	3.85	4.80	
K Cast iron	70	120	0.055	2.40	3.00	3.40	0.115	3.00	4.00	5.00	0.135	3.60	4.80	6.00	
N Al	345	500	0.055	2.50	3.00	3.40	0.115	4.50	6.00	7.50	0.135	5.40	7.20	9.00	
	Cu	200	400	0.055	2.50	3.00	3.40	0.115	3.60	4.80	6.00	0.135	4.30	5.75	7.20
S Ni- alloy	20	28	0.02	1.90	2.55	3.20	0.045	2.40	3.20	4.00	0.055	2.90	3.85	4.80	
	Titanium	40	60	0.02	1.90	2.55	3.20	0.045	2.40	3.20	4.00	0.055	2.90	3.85	4.80
H Hardened	60	90	0.04	1.90	2.55	3.20	0.09	2.40	3.20	4.00	0.11	2.90	3.85	4.80	

▶ 00-99321-025-4265 >>

Workpiece material	Vc m/min.		Ø42			Ø55			Ø65					
	99321		fz mm/tooth	Pitch mm		fz mm/tooth	Pitch mm		fz mm/tooth	Pitch mm				
P Carbon steel	0.25%C	200	0.08	3.00	3.60	4.40	0.12	3.30	4.40	5.50	0.135	3.60	4.80	6.00
	0.45% C	150	0.08	3.00	3.60	4.40	0.12	3.30	4.40	5.50	0.135	3.60	4.80	6.00
	0.60%C	130	0.075	2.70	3.60	4.40	0.11	3.00	4.00	5.00	0.12	3.20	4.30	5.40
	Low alloy steel	120	0.065	2.40	3.20	4.00	0.095	2.60	3.50	4.40	0.11	2.90	3.85	4.80
	High alloy steel	90	0.065	2.40	3.20	4.00	0.095	2.60	3.50	4.40	0.11	2.90	3.85	4.80
M Stainless steel	90	0.065	2.40	3.20	4.00	0.095	2.60	3.50	4.40	0.11	2.90	3.85	4.80	
K Cast iron	120	0.08	3.00	3.60	4.40	0.12	3.30	4.40	5.50	0.135	3.60	4.80	6.00	
N Al	500	0.08	4.00	4.20	4.40	0.12	4.90	6.55	8.20	0.135	5.40	7.20	9.00	
	Cu	200	0.08	3.60	4.00	4.40	0.12	4.00	5.30	6.60	0.135	4.30	5.75	7.20
S Ni- alloy	28	0.03	2.40	3.20	4.00	0.045	2.60	3.50	4.40	0.055	2.90	3.85	4.80	
	Titanium	90	0.03	2.40	3.20	4.00	0.045	2.60	3.50	4.40	0.055	2.90	3.85	4.80
H Hardened	90	0.065	2.40	3.20	4.00	0.095	2.60	3.50	4.40	0.11	2.90	3.85	4.80	

6

NC Helix Drill

Application Example

► Special insert geometry is able to cut different materials >>

- Serrated cutting edge makes the chips short and small, and easier to evacuate.
- Recommended for almost all material types, good for drilling material that generates long, soft chips.



Material: SAE8620		Load 25% P
Vc	= 120 m/min.	
S	= 2250 r.p.m.	
fz	= 0.08 mm/tooth	
F	= 360 mm/min	
P	= 5.6 mm	
T	= 40 sec.	

Material: SUS304 (Stainless steel 304)		Load 25% M
Vc	= 80 m/min.	
S	= 1500 r.p.m.	
fz	= 0.04 mm/tooth	
F	= 120 mm/min	
P	= 5.6 mm	
T	= 118 sec.	

Material: C1100		Load 25% N
Vc	= 200 m/min.	
S	= 3750 r.p.m.	
fz	= 0.08 mm/tooth	
F	= 600 mm/min	
P	= 5.6 mm	
T	= 23 sec.	

Material: AL6061T6		Load 20% N
Vc	= 345 m/min.	
S	= 6500 r.p.m.	
fz	= 0.10 mm/tooth	
F	= 1300 mm/min	
P	= 5.6 mm	
T	= 11 sec.	

Material: TiAl6V4		Load 24% S
Vc	= 80 m/min.	
S	= 1500 r.p.m.	
fz	= 0.04 mm/tooth	
F	= 120 mm/min	
P	= 5.6 mm	
T	= 118 sec.	

Material: Inconel 718 (Drill with internal coolant)		Load 24% S
Vc	= 40 m/min.	
S	= 750 r.p.m.	
fz	= 0.15 mm/tooth	
F	= 225 mm/min	
P	= 2.0 mm	
T	= 177 sec.	

► Suggested insert grades for best result >>

Diameter (mm)	25		
Depth (mm)	50		
Tool (Dc=17mm)	00-99321-016-2030 (external coolant)		
Material	P Carbon Steel	M Stainless Steel	H Tool Steel
	DIN C45E	X5CrNi18-10	X40CrMoV5 1
	SAE 1045	304	H13
	JIS S45C	SUS304	SKD61 (HRC50°)
Insert Grade	NC5072 (P40, TiAlN)	NC5072 (P40, TiAlN)	NC2032 (K20F, TiAlN)
No. of Edges	2	2	2
Vc = (m/min.)	120	60	80
S = r.p.m.	2250	1120	1500
fz = (mm/tooth)	0.1	0.065	0.05
F = (mm/min.)	450	146	150
Pitch = (mm)	5.6	3	3
Machine Load = % (BT40, 22.5KW)	35%	20%	20%
Tool Life (hole)	150	108	18
Chip Removal Volume (cm ³ /min.)	52.66	8.55	8.77

► To produce step hole Ø53.5 & Ø45 by one tool >>



Application

- Hydraulic port for plug-in valve cylinders, counterbore for bolt, and more!

Material	S50C (JIS). High carbon steel									
Tool	99323-LS32-HD40 (Non-standard size)									
Insert	N9MX12T308-NC2032									
Machine	BT40, 22.5 KW									
Coolant	Internal									
Hole	Dc mm	D mm	L mm	Vc m/min.	S r.p.m.	fz mm/tooth	F mm/min.	I mm	P mm	T sec.
A	Ø40	Ø53.5	10	300	2400	0.08	380	6.75	5.0	13.3
B		Ø45.0	32	300	2400	0.08	380	2.5	2.0	39.48

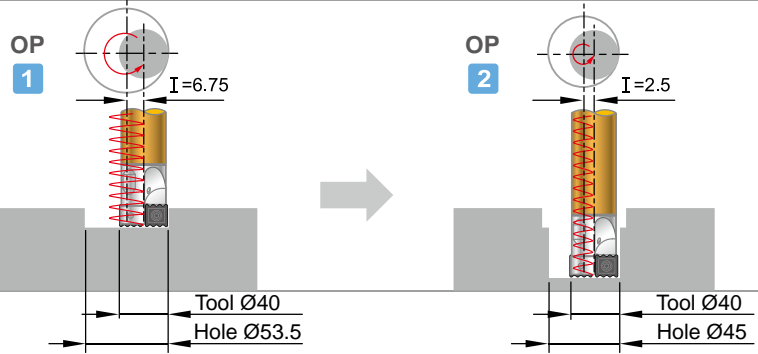

► Just one “NC Helix Drill” can machine different diameters and hole depths.

► Just one tool to drill different diameters and hole depth, possible up to 6xDc >>

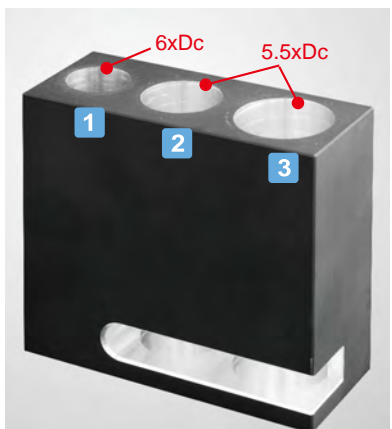

Material	AL6061T6										
Tool	00-99323-016-2030										
Insert	N9MX070204-NC5072										
Machine	HAAS VM-3, BT40, 22.5KW										
Coolant	Internal coolant										
Fig.	Dc mm	D mm	I mm	L mm	Vc m/min.	S r.p.m.	fz mm/tooth	fcut mm/tooth	F mm/min.	P mm	α deg
1	Ø17	20	1.5	100	500	9360	0.04	0.058	1090	3	17.67
2		25	4	95	500	9360	0.08	0.103	1930	4.5	10.16
3		30	6.5	95	500	9360	0.105	0.131	2450	5.6	7.81

► One tool performs multiple patterns >>



Material	AL6061T6						
Tool	00-99323-016-2030 M08-HD17-2030						
Insert	N9MX070204-NC5072						
Machine	HAAS VM-3, BT40, 22.5KW						
Coolant	Internal						
Fig.	Dc mm	Vc m/min.	S r.p.m.	fz mm/tooth	F mm/min.	P mm	T sec.
1	Ø17	200	3800	0.075	570	4	67
2		200	3800	0.075	570	4	95
3		200	3800	0.075	570	4	80

► **Widening a deep hole (6xD) in stainless steel by NC Helix Drill.**
Predrilled 15mm enlarge to 29mm. >>

	Material	Stainless steel					
	Tool	00-99323-016-2030 with 0-398016-150M08 Extension Bar					
	Insert	N9MX070204-NC5072					
	Machine	VMC m/c.					
	Coolant	Internal coolant					
	Dc mm	D mm	L mm	S r.p.m.	fz mm/tooth	F mm/min.	P mm
	Ø17	Ø29	105	1685	0.05	168	1.5

► **Low spindle power is not a problem!**
BT30 machine, Ø30 hole diameter, 3.3xDc drill depth >>

The main purpose of this example is to improve machining efficiency.

Maximum drilling capacity of the 5.5 kw spindle is Ø16 mm

	Material	S50C (JIS), High carbon steel									
	Tool	00-99321-020-2540 / BC20-HD22-2540									
	Insert	N9MX100306-NC2032									
	Machine	BT30, 5.5 KW									
	Coolant	External coolant									
	Dc mm	D mm	L mm	Vc m/min.	S r.p.m.	fz mm/tooth	fcut mm/tooth	F mm/min.	I mm	P mm	T sec.
	Ø22	Ø30	60	200	* 2893	0.12	0.1	600	4	2.8	62

* 3000 r.p.m. is used.

► **NC Helix Drill reduces the spindle load and increases spindle life. >>**

Maximum drilling capacity of the 18 kw spindle is Ø50 mm

	Material	SS400 Low carbon steel									
	Tool	00-99323-025-3050									
	Insert	N9MX12T308-NC5072									
	Machine	Toshiba MPE-2140, CAT-50, 25HP / 18KW									
	Coolant	Internal coolant									
	Dc mm	D mm	L mm	Vc m/min.	S r.p.m.	fz mm/tooth	fcut mm/tooth	F mm/min.	I mm	P mm	T sec.
	Ø27	Ø50	80	119	1400	0.15	0.165	420	11.5	3	275

15% Spindle load only!



Super Power Drill >>>

Deep Hole Drilling Up To 12xD!

5xD & 10xD Ø19mm ~ Ø40mm

It is no doubt that deep hole drilling by indexable drill is always a challenge of the drill makers.

Nine9 "Super Power Drill", featuring by patented indexable center pilot insert design, which is the first time in the world, helping to achieve the cost-effective and good performance, making deep hole drilling up to 12xD possible.

P M K N H



Features >>>



▶ Indexable Drills With Carbide Center Pilot Insert

- Better surface finish.
- Better straightness.
- Better roundness.



▶ Patented Pocket Design

- Lateral cutting forces can be absorbed by center insert due to a patented pocket design.
- The unique design of insert pocket provides the best accuracy and rigidity of center insert.
- The center and peripheral inserts are positioned in order to divide the cutting chips into smaller spiral shape.
- It designed for optimum chip breaking and good edge preparation for longer tool life.





Applications

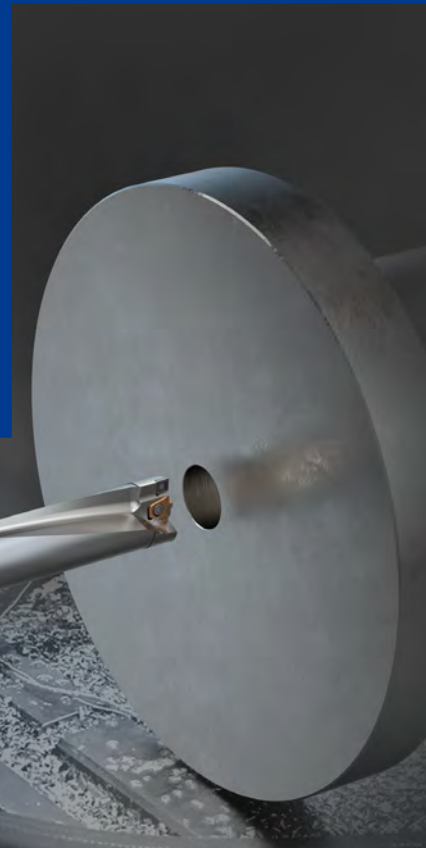
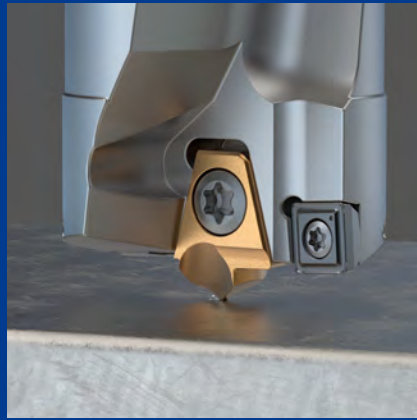

“

- With patented center pilot insert which aids accurate and steady deep hole drilling.
- Better finished surface, potentially reducing boring time.

”

Performance

Heat-Exchanger



Semi-Finished Product



Continuous Track



7

Super Power Drill

Holder 19mm~40mm

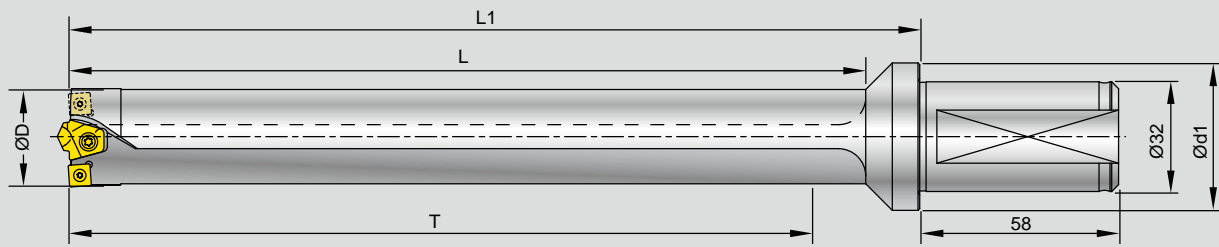

Parts No.	ØD mm (inch)	T	L	L1	Ød1	Insert / Screw / Key	
						Center	Periphery
00-99307-19100	19 (0.748")	100	119	134	39		N9GX04T002 x 1 pc. *NS-18037 / 0.6Nm NK-T6
00-99307-19150		150	169	184			
00-99307-19200		200	219	239			
00-99307-20100	20 (0.787")	100	120	134	39		N9GX05T103 x 1 pc. *NS-20045 / 0.6Nm NK-T6
00-99307-20150		150	170	184			
00-99307-20200		200	220	239			
00-99307-21100	21 (0.827")	100	120	134	39		NK-T6
00-99307-21150		150	170	184			
00-99307-21200		200	220	239			
00-99307-22100	22 (0.866")	100	125	139	39	99307-CD6 x 1 pc.	
00-99307-22150		150	175	189			
00-99307-22200		200	225	239			
00-99307-23100	23 (0.905")	100	125	139	39	NS-35080 2.5Nm	NK-T15
00-99307-23150		150	175	189			
00-99307-23200		200	225	239			
00-99307-24100	24 (0.945")	100	126	139	39		N9GX060204 x 1 pc. *NS-22062 / 0.9Nm NK-T7
00-99307-24150		150	176	189			
00-99307-24200		200	226	239			
00-99307-24250		250	276	289			
00-99307-25100	25 (0.984")	100	126	139	39		
00-99307-25150		150	176	189			
00-99307-25200		200	226	239			
00-99307-25250		250	276	289			
00-99307-26150	26 (1.024")	150	176	189	39		
00-99307-26200		200	226	239			
00-99307-26250		250	276	289			
00-99307-27150	27 (1.630")	150	181	198	43	99307-CD8 x 1 pc.	N9GX060204 x 2 pcs. *NS-22062 / 0.9Nm NK-T7
00-99307-27200		200	231	248			
00-99307-27250		250	281	298			
00-99307-28150	28 (1.102")	150	181	198	43	NS-35120 2.5Nm	NK-T7
00-99307-28200		200	231	248			
00-99307-28250		250	281	298			
00-99307-29150	29 (1.142")	150	182	198	43	NK-T15	
00-99307-29200		200	232	248			
00-99307-29250		250	282	298			
00-99307-29300		300	332	348			

*Torque screwdriver is recommended.

7

Super Power Drill



Parts No.	ØD mm (inch)	T	L	L1	Ød1	Insert / Screw / Key	
						Center	Periphery
00-99307-30150		150	182	198			
00-99307-30200	30 (1.181")	200	232	248	43		
00-99307-30250		250	282	298			
00-99307-30300		300	332	348			
00-99307-31150	31 (1.220")	150	188	198	43		
00-99307-31200		200	238	248			
00-99307-31250		250	288	298			
00-99307-31300		300	338	348			
00-99307-32150	32 (1.260")	150	188	203	43		
00-99307-32200		200	238	253			
00-99307-32250		250	288	303			
00-99307-32300		300	338	353			
00-99307-33150	33 (1.300")	150	189	203	43		
00-99307-33200		200	239	253			
00-99307-33250		250	289	303			
00-99307-33300		300	339	353			
00-99307-34150	34 (1.339")	150	189	203	43		
00-99307-34200		200	239	253			
00-99307-34250		250	289	303			
00-99307-34300		300	339	353			
00-99307-34350		350	389	403			
00-99307-35200	35 (1.378")	200	245	258	43		
00-99307-35250		250	295	308			
00-99307-35300		300	345	358			
00-99307-35350		350	395	408			
00-99307-36200	36 (1.417")	200	245	258	43		
00-99307-36250		250	295	308			
00-99307-36300		300	345	358			
00-99307-36350		350	395	408			
00-99307-37200	37 (1.457")	200	246	258	43		
00-99307-37250		250	296	308			
00-99307-37300		300	346	358			
00-99307-37350		350	396	408			
00-99307-38200	38 (1.496")	200	246	258	43		
00-99307-38250		250	296	308			
00-99307-38300		300	346	358			
00-99307-38350		350	396	408			
00-99307-39200	39 (1.535")	200	247	258	43		
00-99307-39250		250	297	308			
00-99307-39300		300	346	358			
00-99307-39350		350	397	408			
00-99307-40200	40 (1.575")	200	247	258	43		
00-99307-40250		250	297	308			
00-99307-40300		300	347	358			
00-99307-40350		350	397	408			

N9GX060204 x 2 pcs.
*NS-22055 / 0.9Nm
NK-T7

99307-CD8 x 1 pc.

NS-35120
2.5Nm
NK-T15

N9GX090308 x 2 pcs.
NS-30072 / 2.0Nm
NK-T9



Super Power Drill

Insert

► Featuring by patented indexable center pilot insert design

- High precision fully ground and edge honing to increase tool life and surface finish.
- Special geometry design delivers the benefits of the center drill in guiding position and eliminates the defects caused by the chip flow from the gap between the center drill and insert.

► Center Pilot Insert >>

- NC2032** : • K20F grade, AlTiN coated, fully ground, honed cutting edge.
 • For carbon steel & alloy steel C<0.3% and stainless steel.
- NC40** : • P35 grade, TiN coated, fully ground, honed cutting edge.
 • For carbon steel & alloy steel C>0.3% and stainless steel.



Parts No.	Coating	Grade		Dimensions		Screw	Key	
				Ød	S			
99307-CD6	NC2032	AlTiN	K20F		6	4	NS-35080 2.5Nm	NK-T15
	NC40	TiN	P35					
99307-CD8	NC2032	AlTiN	K20F		8	6	NS-35120 2.5Nm	NK-T15
	NC40	TiN	P35					

► Periphery Insert >>

- Fully ground carbide insert
- Each insert has 4 cutting edges.
- Patented Dual-relief angle insert are designed for optimum chip breaking and good edge preparation for longer tool life.



- NC2032** : • K20F grade, AlTiN coated, honed cutting edge for carbon steel, alloy steel, casting iron, stainless steel and hardened steel up to HRC 50.
- NC40** : • P35 grade, tougher insert with special chip breaker, TiN coated, for low carbon steel and stainless steel.
 • Only available for insert N9GX06020431 and N9GX09030831.

Parts No.	Coating	Grade		Dimensions			Screw	Key	
				L	S	re			
N9GX04T002	NC2032	AlTiN	K20F		4.07	1.8	0.2	*NS-18037 0.6Nm	NK-T6
N9GX05T103	NC2032	AlTiN	K20F		5.07	2.0	0.3	*NS-20045 0.6Nm	
N9GX060204	NC2032	AlTiN	K20F		6.35	2.38	0.4	*NS-22062 0.9Nm	NK-T7
N9GX06020431	NC40	TiN	P35		6.35	2.38	0.4		
N9GX090308	NC2032	AlTiN	K20F		9.52	3.18	0.8	NS-30072 2.0Nm	NK-T9
N9GX09030831	NC40	TiN	P35		9.52	3.18	0.8		

*Torque screwdriver is recommended.





7

Super Power Drill

Performance

▶ NC Spot Drill + Super Power Drill Apply on Stationary Machine Tool >>

To get better position accuracy and diameter tolerance first, and make sure the size of the spot according to following.

Step 1	Tool: 99616-14-12-02S to make a spot.		Pilot Insert	99307-CD6	99307-CD8
			Spotting Diameter	ø5 mm	ø7 mm
			Spotting Depth	2.8 mm	3.8 mm
Step 2	Tool: 99307-20200 to make a 10xD deep hole.		Then the spot hole will guide the pilot insert at the beginning and stabilized the drill to get the perfect drilling operation.		
Result	Cutting Speed	Feed rate	Surface		
Without spotting	Vc= 80 m/min.	f = 0.1 mm/rev.			
With spotting	Vc= 120 m/min. ↑	f = 0.1 mm/rev.	 Finished surface is better and accurate. 		

▶ Good surface finish >>

Center Pilot Insert	Material: Carbon steel (S45C)		
99307-CD8-NC40 N9GX060204-NC2032	Vc	80	m/min.
	S	880	r.p.m.
	f	0.10	mm/rev.
	F	88.0	mm/min.
	Ra	2.139	μm
	Rmax	11.8	μm



```

Perthometer M1
bject
lame
t 5.600 mm
s Standard 2.5 μm
c 0.800 mm
a 2.139 μm
z 10.6 μm
max 11.8 μm
Pc(0.5,-0.5) 103 /c
Profile
c 0.800 mm
ER 5.00 μm
    
```

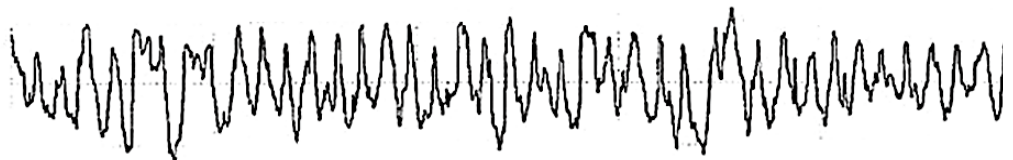

7

Super Power Drill

Technical Guide

Machining Power Requirement for Drilling

Material Classification for Calculation

There are an extremely wide range of materials and different machining operations in the metal cutting industry. We follow the ISO material group and color to make brief information for calculation of the required power for super power drill, the main effective parameter is “specified cutting force”, please use following table and formula.

	Material Group	Material Type and description	Hardness (HB)	Strength (N/mm ²)	Specified cutting force Kc (N/mm ²)
P	1.10	Carbon steel C<0.3%, free cutting steels	~125	500-850	1900
	1.20	Carbon steel C>0.3%	~150	850-1000	2100
	1.30	Low alloy steel C<0.3%	180	Up to 750	2100
	1.40	Low alloy steel C>0.3%	200	750-1200	2600
	1.50	High alloy steel	200	800-1200	2600
	1.60	Tool steel, harder steels for toughening. Martensitic stainless steels.	<230	850-1100	2200
	1.70	Casting steel			2900
M	2.10	Free cutting Stainless steel Austenitic stainless steels	200	490-700	2300
	2.20	Difficult Stainless steel Austenitic stainless steels and duplex	175	650-850	2450
K	3.10	Grey casting iron	180	250-350	1100
	3.20	Malleable casting iron	230	Up to 600	1200
	3.30	Nodular casting iron	250	Up to 800	1800
N	4.10	Al- alloys(Si<12%)	60	230-310	500
	4.20	Al-alloys(Si>12%)	75	150-200	750
	4.30	Non-ferrous materials, Zirconium, Magnesium, Copper alloys, etc.	100	150-200	800
	4.40	Carbon and graphite composites, plastics, wood, rubbers, etc.	—	—	—
S	5.10	Nickel-based heat-resistant alloys	250		3500
	5.20	Cobalt-based heat resistant alloys	350		4150
	5.30	Iron-based heat resistant alloys	250		3050
H	6.10	Tool steels and hardened steels	55HRC		4500
	6.20	Hardened cast iron	—	—	—

Formulas for Calculation

feed force(KN) Ff $Ff = \frac{ap \times f \times Kc}{2000}$	Drilling torque (Md) torque=(Nm) $Md = \frac{f \times \pi \times D^2 \times Kc}{4000} \text{ Nm}$	f = feed rate	mm/rev.
		Vc = cutting speed	m/min.
		D = drill diameter	mm
		Kc = specified cutting force	N/mm ²

7

Super Power Drill

Technical Guide

► Please pay attention to following conditions before you start.

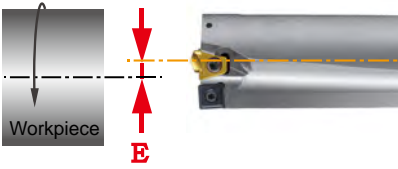
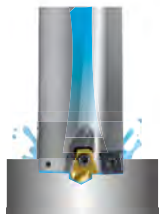
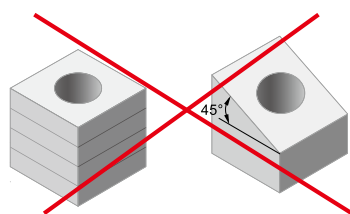
Center misalignment	Internal coolant	Application of drilling
<p>E must be < 0.05mm.</p> 	<p>High volume is recommended. Minimum coolant pressure is 10 bar. (150 psi)</p> 	<p>Not apply for stack drilling and angled surface drilling.</p> 

- Recommend to make a spot hole first by spot drill. See page 7-127 for detail.
- The cutting speed relates to the periphery inserts, The feed rate depends on the load of the center pilot insert.
- The best condition will create short cutting chips. The feed rate can be applied $\pm 25\%$ of the recommended value depended on the shape of the cutting chips.
- Be careful to monitor the spindle power consumption !
When the spindle load is 15% higher than starting power consumption, please change the periphery insert to next new cutting edge and change a new center pilot insert.
- Increase 20% of the cutting speed and the feed rate for horizontal spindle machine.

Cutting Data

Work piece material	T= Length/ Dia.	Vc (m/min.)	f (mm/rev.)				Grade of Insert	
			N9GX04T002	N9GX05T103	N9GX060204	N9GX090308	Center	Periphery
			Dia.19	Dia.20-21	Dia.22-34	Dia.35-40		
P Carbon steel C<0.3% Ex.:S25C, SS41 Carbon steel C>0.3% Ex.:S50C, P5 Low alloy steel C<0.3% Ex.:SCM415 Low alloy steel C>0.3% Ex.:SCM440 High alloy steel Ex.:SKD11 Casting steel	T<7D	80~150	0.03~0.07	0.04~0.08	0.06~0.10	0.08~0.12	NC2032	NC2032
	T>7D	60~120	0.03~0.07	0.04~0.08	0.06~0.10	0.08~0.12		
	T<7D	80~130	—	—	0.06~0.10	0.08~0.12	NC40	NC40
	T>7D	60~100	—	—	0.06~0.10	0.08~0.12		
	T<7D	80~150	0.04~0.08	0.04~0.10	0.06~0.12	0.08~0.15	NC40	NC2032
	T>7D	60~120	0.04~0.08	0.04~0.10	0.06~0.12	0.08~0.15		
	T<7D	60~150	0.04~0.08	0.04~0.10	0.06~0.10	0.08~0.12	NC2032	NC2032
	T>7D	40~120	0.04~0.08	0.04~0.10	0.06~0.10	0.08~0.12		
	T<7D	60~150	0.04~0.08	0.04~0.10	0.06~0.12	0.08~0.15	NC40	NC2032
	T>7D	40~120	0.04~0.08	0.04~0.10	0.06~0.12	0.08~0.15		
T<7D	60~120	0.03~0.07	0.04~0.08	0.06~0.10	0.08~0.12	NC40	NC2032	
T>7D	40~100	0.03~0.07	0.04~0.08	0.06~0.10	0.08~0.12			
T<7D	60~120	0.03~0.07	0.04~0.08	0.06~0.10	0.08~0.12	NC40	NC2032	
T>7D	40~100	0.03~0.07	0.04~0.08	0.06~0.10	0.08~0.12			
M Stainless steel Ex.:SUS304	T<7D	60~120	0.03~0.06	0.04~0.07	0.05~0.08	0.06~0.10	NC2032	NC2032
	T>7D	40~100	0.03~0.06	0.04~0.07	0.05~0.08	0.06~0.10		
	T<7D	60~120	—	—	0.05~0.08	0.06~0.10	NC40	NC40
T>7D	40~100	—	—	0.05~0.08	0.06~0.10			
K Casting Iron Ex.:FC25	T<7D	60~120	0.04~0.08	0.04~0.10	0.06~0.10	0.08~0.12	NC40	NC2032
	T>7D	40~100	0.04~0.08	0.04~0.10	0.06~0.10	0.08~0.12		
N Al, and non-ferrous metal Ex.:A6061	—	—	—	—	—	—	—	—
	—	—	—	—	—	—	—	—
H Hardened steel <HRC 50° Ex.:SKD61	T<7D	50~80	0.03~0.06	0.04~0.07	0.05~0.08	0.06~0.10	NC40	NC2032
	T>7D	40~60	0.03~0.06	0.04~0.07	0.05~0.08	0.06~0.10		



Super Drill >>>

3xD & 4xD

Ø10mm ~ Ø30mm



▶ **Diameter Range**

3xD : Ø10 ~ Ø30mm

4xD : Ø16 ~ Ø30mm

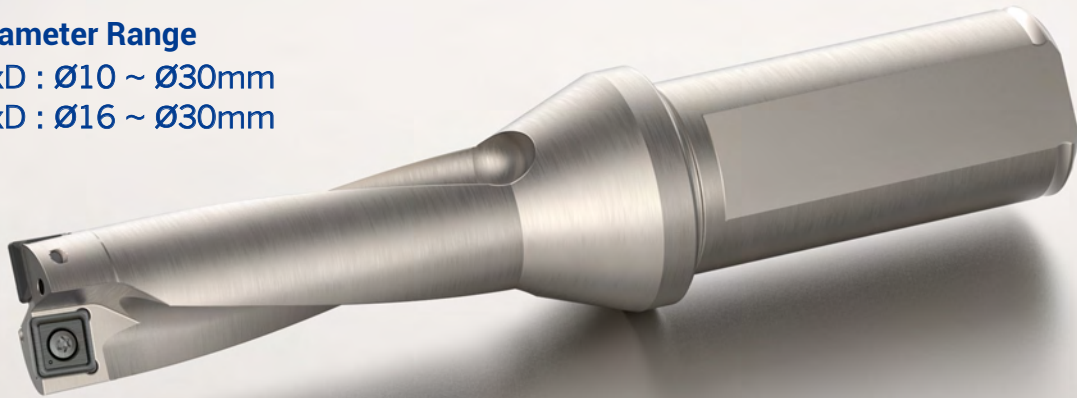

Features >>>

▶ **Smaller Cutting Chip**

- The center and peripheral inserts are positioned in order to divide the cutting chips into smaller spiral shape. It helps the cutting chip to be removed faster and easier.
- Designed for high productivity, high speed cutting.
- With internal coolant.

▶ **Better Surface Finish And Better Diameter Accuracy**

- Special insert positioning to balance the cutting forces, better surface finish and diameter accuracy are achievable.



▶ **4 Cutting Edges Insert, AlTiN Coated**

- Chip breaker of SD insert provides excellent chip control property due to its engineered design.
- Easy and simple change of cutting edge without inconvenience.



Applications

▶ Angled Surfaces

- Possible to drill into angled surfaces without pre-drilling

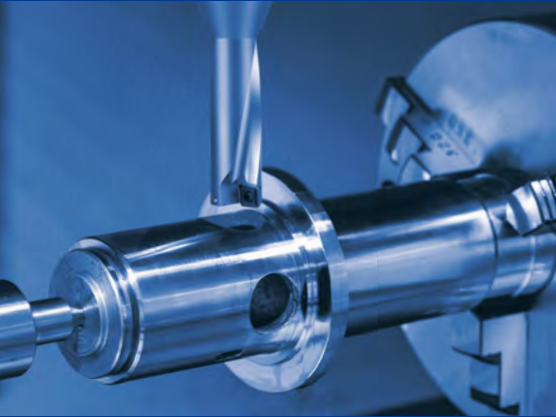
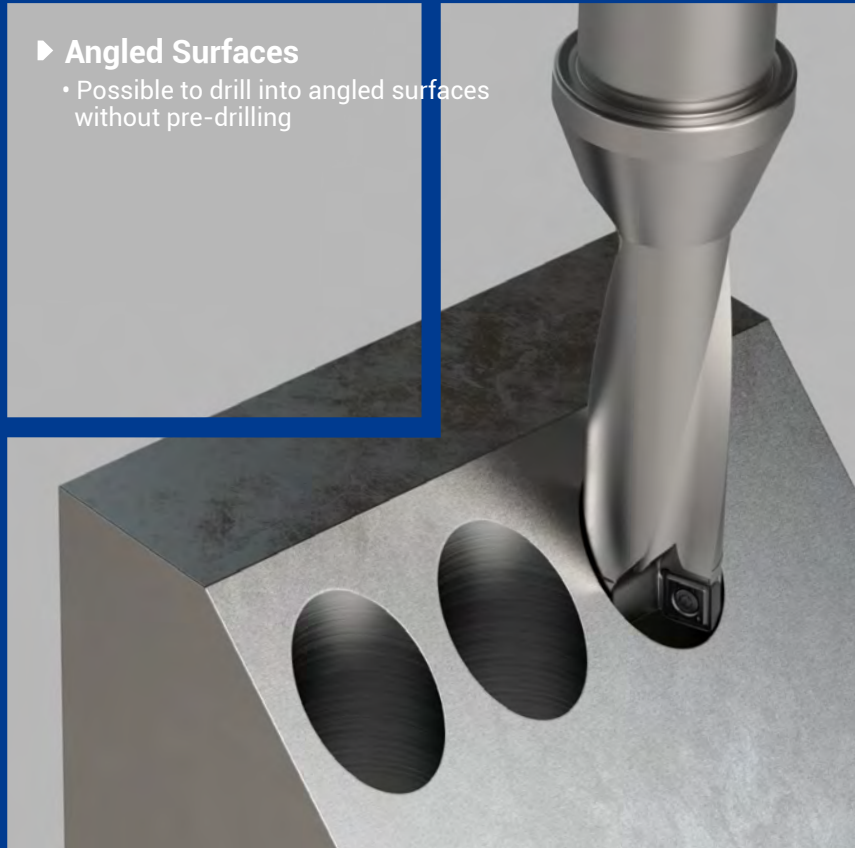

“

- Smallest indexable drill from 10mm.
- 4 cutting edges per insert,
- Same insert for outer and inner insert.

”

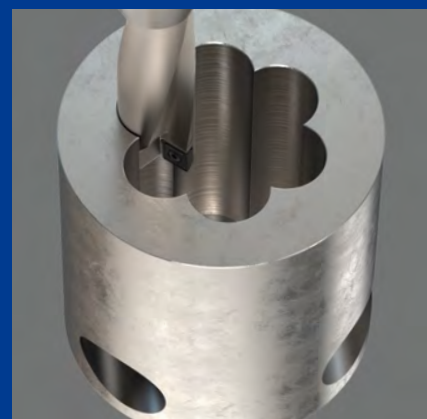

7

Super Drill

Holder 3xD 10mm~30mm

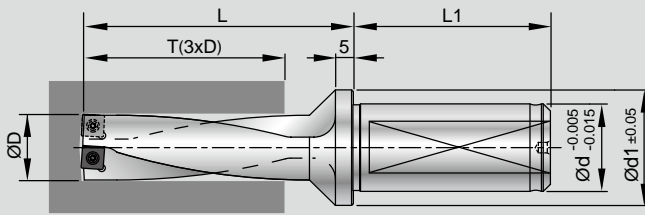

Parts No.	ØD	T	L	L1	Ød	Ød1	Insert Screw / Key	Radial Adjustment	D max
00-99313-10	10.0	30.0	49					0.25	10.5
00-99313-10.3	10.3	30.9	52					0.25	10.8
00-99313-10.5	10.5	31.5	52					0.25	11.0
00-99313-11	11.0	33.0	52	49	20	27	N9GX04T002	0.20	11.4
00-99313-11.5	11.5	34.5	55				*NS-18037 / 0.6Nm NK-T6	0.20	11.9
00-99313-12	12.0	36.0	55					0.15	12.3
00-99313-12.5	12.5	37.5	58					0.15	12.8
00-99313-13	13.0	39.0	58					0.30	13.6
00-99313-13.5	13.5	40.5	61					0.30	14.1
00-99313-14	14.0	42.0	61	49	20	27	N9GX05T103	0.25	14.5
00-99313-14.5	14.5	43.5	64				*NS-20045 / 0.6Nm NK-T6	0.25	15.0
00-99313-15	15.0	45.0	64					0.20	15.4
00-99313-15.5	15.5	46.5	67					0.20	15.9
00-99313-16	16.0	48.0	74					0.40	16.8
00-99313-16.5	16.5	49.5	76					0.40	17.3
00-99313-17	17.0	51.0	76					0.35	17.7
00-99313-17.5	17.5	52.5	78	55	25	31	N9GX060204	0.35	18.2
00-99313-18	18.0	54.0	78				*NS-22055 / 0.9Nm NK-T7	0.30	18.6
00-99313-18.5	18.5	55.5	80					0.30	19.1
00-99313-19	19.0	57.0	80					0.25	19.5
00-99313-19.5	19.5	58.5	85					0.25	20.0
00-99313-20	20.0	60.0	85					0.50	21.0
00-99313-20.5	20.5	61.5	87					0.50	21.5
00-99313-21	21.0	63.0	87					0.45	21.9
00-99313-21.5	21.5	64.5	88					0.45	22.4
00-99313-22	22.0	66.0	88	55	25	31	N9GX070304	0.40	22.8
00-99313-22.5	22.5	67.5	90				*NS-25060 / 0.9Nm NK-T7	0.40	23.3
00-99313-23	23.0	69.0	90					0.35	23.7
00-99313-23.5	23.5	70.5	92					0.35	24.2
00-99313-24	24.0	72.0	92					0.30	24.6
00-99313-25	25.0	75.0	114					0.50	26.0
00-99313-26	26.0	78.0	115					0.50	27.0
00-99313-27	27.0	81.0	117	58	32	43	N9GX090308	0.40	27.8
00-99313-28	28.0	84.0	126				NS-30072 / 2.0Nm NK-T9	0.40	28.8
00-99313-29	29.0	87.0	127					0.30	29.6
00-99313-30	30.0	90.0	130					0.30	30.6

*Torque screwdriver is recommended.

7

Super Drill

Holder 4xD 16mm~30mm

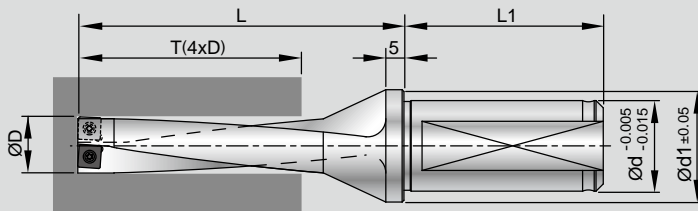

Parts No.	ØD	T	L	L1	Ød	Ød1	Insert Screw / Key	Radial Adjustment	D max
00-99314-16	16	64	90				☐ N9GX060204	0.40	16.8
00-99314-17	17	68	93				*NS-22055	0.35	17.7
00-99314-18	18	72	96	55	25	31	0.9Nm	0.30	18.6
00-99314-19	19	76	99				NK-T7	0.25	19.5
00-99314-20	20	80	105				☐ N9GX070304	0.50	21.0
00-99314-21	21	84	108				*NS-25060	0.45	21.9
00-99314-22	22	88	110	55	25	31	0.9Nm	0.40	22.8
00-99314-23	23	92	113				NK-T7	0.35	23.7
00-99314-24	24	96	116					0.30	24.6
00-99314-25	25	100	139					0.50	26.0
00-99314-26	26	104	141				☐ N9GX090308	0.50	27.0
00-99314-27	27	108	144				NS-30072	0.40	27.8
00-99314-28	28	112	154	58	32	43	2.0Nm	0.40	28.8
00-99314-29	29	116	156				NK-T9	0.30	29.6
00-99314-30	30	120	160					0.30	30.6

*Torque screwdriver is recommended.

Nine9 SD

Other makers

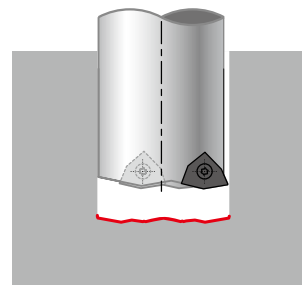

7

Super Drill

Insert

► Features >>

- Fully ground dual-relief insert, for improved surface finish and higher feed rate.
- Primary relief angle is to increase the toughness of the insert, secondary relief angle is to strengthen the axial feed rate.

► Inserts >>

NC2032: • K20F grade, AlTiN coated, for carbon steel, alloy steel, casting iron, stainless steel and hardened steel up to HRC 50.



NC2032

Parts No.	Coating	Grade	Dimensions	Screw	Key			
						L	S	Re
N9GX04T002	NC2032	AlTiN	K20F	4.07	1.8	0.2	*NS-18037 0.6Nm	NK-T6
N9GX05T103	NC2032	AlTiN	K20F	5.07	2.0	0.3	*NS-20045 0.6Nm	NK-T6
N9GX060204	NC2032	AlTiN	K20F	6.35	2.38	0.4	*NS-22055 0.9Nm	NK-T7
N9GX070304	NC2032	AlTiN	K20F	7.94	3.18	0.4	*NS-25060 0.9Nm	NK-T7
N9GX090308	NC2032	AlTiN	K20F	9.52	3.18	0.8	NS-30072 2.0Nm	NK-T9

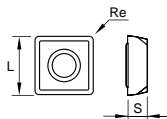

*Torque screwdriver is recommended.

► Functions in various conditions >>

Material classification for calculation of cutting speed & feed rate

Application	* Regular Surface	Cross Holes	Stack Drilling	Round Work Piece Offset Drilling
Work Piece Shape				
Cutting Speed Vc (m/min.)	100%	80%	80%~70%	80%~60%
Feed Rate (mm/rev.)	100%	80%	80%~70%	80%~60%
Application	Plunge Drilling	Concave Surfaces	Angled Surfaces	Cone Work Piece Offset Drilling
Work Piece Shape				
Cutting Speed Vc (m/min.)	80%	80%	80%~70%	80%~70%
Feed Rate (mm/rev.)	80%	80%	80%~70%	80%~70%

* SPD, SD both are suitable.

Cutting Data

Work piece material	T= Length/ Dia.	Vc (m/min.)	f (mm/rev.)					Grade of Insert		
			N9GX 04T002	N9GX 05T103	N9GX 060204	N9GX 070304	N9GX 090308			
			Dia. 10~12.5	Dia. 13~15.5	Dia. 16~19.5	Dia. 20~24	Dia. 25~30			
P	Carbon steel C<0.3% Ex.:S25C, SS41	T=3D	80~250	0.03~0.06	0.04~0.08	0.06~0.10	0.06~0.10	0.08~0.12	NC2032	
		T=4D	60~180	—	—	0.06~0.10	0.06~0.10	0.08~0.12		
	Carbon steel C>0.3% Ex.:S50C, P5	T=3D	80~300	0.04~0.08	0.06~0.10	0.06~0.12	0.08~0.12	0.08~0.15	NC2032	
		T=4D	60~150	—	—	0.06~0.12	0.08~0.12	0.08~0.15		
	Low alloy steel C<0.3% Ex.:SCM415	T=3D	80~250	0.04~0.08	0.04~0.08	0.06~0.10	0.06~0.10	0.08~0.12	NC2032	
		T=4D	60~150	—	—	0.06~0.10	0.06~0.10	0.08~0.12		
	Low alloy steel C>0.3% Ex.:SCM440	T=3D	80~250	0.04~0.08	0.04~0.10	0.06~0.12	0.06~0.12	0.08~0.15	NC2032	
		T=4D	60~150	—	—	0.06~0.12	0.06~0.12	0.08~0.15		
	High alloy steel Ex.:SKD11	T=3D	60~150	0.03~0.06	0.04~0.08	0.06~0.10	0.06~0.10	0.08~0.12	NC2032	
		T=4D	50~100	—	—	0.06~0.10	0.06~0.10	0.08~0.12		
	Casting steel	T=3D	80~180	0.03~0.06	0.04~0.08	0.06~0.10	0.06~0.10	0.08~0.12	NC2032	
		T=4D	60~120	—	—	0.06~0.10	0.06~0.10	0.08~0.12		
	M	Stainless steel Ex.:SUS304	T=3D	60~150	0.03~0.06	0.04~0.08	0.04~0.10	0.06~0.10	0.06~0.12	NC2032
			T=4D	50~100	—	—	0.04~0.10	0.06~0.10	0.06~0.12	
K	Casting Iron Ex.:FC25	T=3D	80~120	0.04~0.08	0.06~0.08	0.06~0.08	0.06~0.10	0.08~0.12	NC2032	
		T=4D	60~100	—	—	0.06~0.08	0.06~0.10	0.08~0.12		
H	Hardened steel <HRC 50° Ex.:SKD61	T=3D	60~100	0.03~0.06	0.04~0.08	0.05~0.08	0.06~0.08	0.06~0.10	NC2032	
		T=4D	40~80	—	—	0.05~0.08	0.06~0.08	0.06~0.10		

* The maximum misalignment of the drill center is +0.2 mm/-0.5 mm on the CNC lathe.

Metric	
$S = \frac{Vc \times 1000}{\pi \times d}$	d = diameter -mm S = Spindle Speed -r.p.m.
$F = S \times f$	Vc = Cutting Speed -m/min. f = mm/rev. F = mm/min.

Inch	
$S = \frac{(3.82 \times SFM)}{d}$	d = diameter-inch S = Spindle Speed-r.p.m.
$F = f \times S$	SFM = Surface Speed-ft./min. f = IPR = inch/rev. F = IPM=RPM x f / 25.4

7

Super Drill



Power Mill >>>

Indexable Milling Cutter 10mm

Patented dual relief angle insert!

P **K**

- ▶ Higher Feed Rate.
- ▶ Higher Wearing Resistance!
- ▶ Fast Chip Removal!

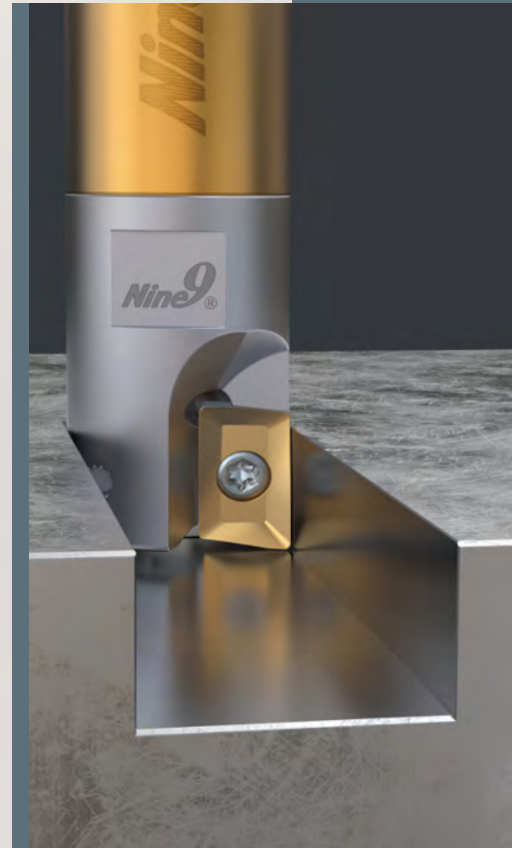

Features >

▶ Applications

A Series	Shoulder Face Mills
	Dia. range: $\varnothing 10 \sim \varnothing 25\text{mm}$
C Series	Torus Radius Mills
	Dia. range: $\varnothing 10 \sim \varnothing 26\text{mm}$

A Series Shoulder Face Mills

► Features

- Strong insert with high positive geometry and helical cutting edges.
- Shoulder mill with good cutting performance and cutting edge strength, which produce perfect 90° shoulders.

► Cylindrical Shank >>

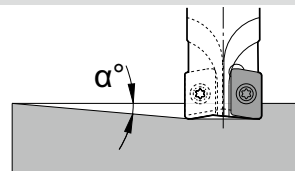
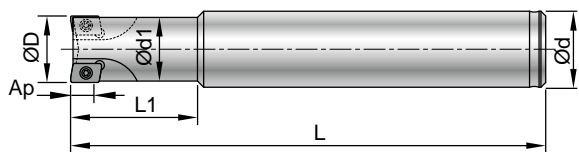

Part No.	Type	ØD	Ød h6	Ød1	α°	L1	L	⊕ Z	Ap	Insert type
00-99802-BC10-10A06	BC10-10A06-100	10	10	9.8	5.0	40	100	2	5	A9...0602...
00-99802-BC12-10A06	BC12-10A06-80	10	12	9.8	5.0	20	80	2		
00-99802-BC12-11A06	BC12-11A06-80	11	12	10.8	4.5	22	80	2		
00-99802-BC12-12A06	BC12-12A06-80	12	12	11.4	4.0	24	80	2		
00-99802-BC16-13A06	BC16-13A06-100	13	16	12.4	3.5	26	100	2		
00-99802-BC16-14A06	BC16-14A06-100	14	16	13.4	3.0	28	100	2		
00-99802-BC16-15A06	BC16-15A06-100	15	16	14.4	2.5	30	100	3		
00-99802-BC16-16A06	BC16-16A06-100	16	16	15.4	2.0	32	100	3	9	A9...1035...
00-99802-BC16-16A10	BC16-16A10-100	16	16	14.5	2.5	32	100	2		
00-99802-BC20-20A10	BC20-20A10-120	20	20	18.5	2.0	40	120	3		
00-99802-BC25-25A10	BC25-25A10-150	25	25	23.5	1.3	50	150	3		

► Screw-Fit Type >>

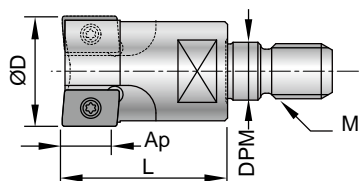

Part No.	Type	ØD	α°	L	M	DPM	⊕ Z	Ap	Insert type
00-99805-M05-10A06	M05-10A06	10	5.0	13	M5xP0.8	5.5	2	5	A9...0602...
00-99805-M05-11A06	M05-11A06	11	4.5	13	M5xP0.8	5.5	2		
00-99805-M06-12A06	M06-12A06	12	4.0	13	M6xP1.0	6.5	2		
00-99805-M06-13A06	M06-13A06	13	3.5	13	M6xP1.0	6.5	2		
00-99805-M08-14A06	M08-14A06	14	3.0	13	M8xP1.25	8.5	2		
00-99805-M08-15A06	M08-15A06	15	2.5	15	M8xP1.25	8.5	3		
00-99805-M08-16A06	M08-16A06	16	2.0	15	M8xP1.25	8.5	3		
00-99805-M08-17A06	M08-17A06	17	1.5	15	M8xP1.25	8.5	3	9	A9...1035...
00-99802-M08-16A10	M08-16A10	16	2.5	25	M8xP1.25	8.5	2		
00-99802-M10-20A10	M10-20A10	20	2.0	30	M10xP1.5	10.5	3		
00-99802-M12-25A10-3T	M12-25A10-3T	25	1.3	35	M12xP1.75	12.5	3		
00-99805-M12-25A10	M12-25A10	25	1.3	20	M12xP1.75	12.5	3		

* Refer to page 9-156 for extension bars.

A Series Shoulder Face Mills



NC5072



U-NC2023



H-NC2033



H-NC9031

Insert

- U type insert is fully ground for reducing the cutting resistance during the cutting, best choice for long shank cutter.
- H type with high positive rake angle, shape edge.

NC5072 :

- High rigidity, special edge honing, resistance of impact during milling operation.
- Special chip breaker design for high removal rate.
- P40 tougher grade for smooth cutting, good for all kinds of steel.

U-NC2032 :

- High rigidity, special edge honing, resistance of impact during milling operation.
- For all kinds of steel from < 50 HRC, carbon steel, alloy steel, cast iron, aluminum and non-ferrous metal.

H-NC2033 :

- Sharp cutting edge and high positive rake angle, good for finishing milling and surface roughness.
- Re 0.5 and Re1.0 for your option.
- Suitable for all kinds of steel.

H-NC9031 :

- Sharp cutting edge and high positive rake angle, low friction coefficient for non-ferrous metal.
- Good for Al, Al-alloy, Copper, Copper alloy and Non-Ferrous metal.

Insert Size	Parts No.		Coating	Grade		Dimensions					Screw / Key
						L	W	S	Re	Ap	
06	A9MT060205	NC5072	TiAlN	P40		6.5	4	2.45	0.5	5	*NS-18037 0.6Nm / NK-T6
	A9GT060201U	NC2032	TiAlN	K20F					0.1		
	A9GT060202U	NC2032	TiAlN	K20F					0.2		
	A9GT060205U	NC2032	TiAlN	K20F					0.5		
	A9GT060201H	NC2033	TiAlN	K20F					0.1		
		NC9031	TiN	K20F					0.2		
	A9GT060202H	NC2033	TiAlN	K20F					0.2		
		NC9031	TiN	K20F					0.5		
	A9GT060205H	NC2033	TiAlN	K20F					0.5		
		NC9031	TiN	K20F					1.0		

*Torque screwdriver is recommended.

NC2032 :

- High rigidity, special edge honing, resistance of impact during milling operation.
- Special chip breaker design for high removal rate.
- Good for hard cutting carbon steel and alloy steel.

H-NC9031 :

- Sharp cutting edge and high positive rake angle, low friction coefficient for non-ferrous metal.
- Good for Al, Al-alloy, Copper, Copper alloy and Non-Ferrous metal.

Insert Size	Parts No.		Coating	Grade		Dimensions					Screw / Key
						L	W	S	Re	Ap	
10	A9MT1035	NC2032	TiAlN	K20F		10	6.6	3.5	0.4	9	*NS-25060 0.9Nm NK-T7
	A9GT103505H	NC9031	TiN	K20F					0.5		

*Torque screwdriver is recommended.

Cutting Data

- Reduce the feed rate 30% from the below table for slotting operation.
- Ramping angle should be under α° . (Please refer to holder specifications)

▶ Insert Size: 6.5mm (Holder Ø10~Ø17mm) >>

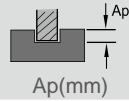
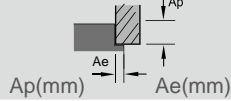
Work Material	Sample Code (JIS)	Vc (m/min)	fz (mm/tooth)			Grade of Insert	
P Carbon Steel	P5	80~150	0.03~0.07	1.5	4	1.5	NC5072 NC2033
	SCM440	80~150	0.03~0.07	1.5	4	1	NC5072 NC2033
	SKD11	60~120	0.03~0.07	1	2.5	1	NC5072 NC2033
M Stainless Steel	SUS304	60~120	0.01~0.05	0.5	2	1	NC5072 NC2033
K Casting Iron Malleable Cast Iron, Grey Cast Iron	FC25	60~120	0.03~0.07	1	2.5	1	NC5072 NC2033
		100~150	0.03~0.07	1.5	4	1.5	NC5072 NC2033
N Al, Al-alloy	A6061	200~500	0.03~0.07	2	4	2	NC9031

▶ Insert Size: 10mm (Holder Ø16~Ø25mm) >>

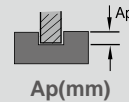
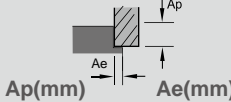
Work Material	Sample Code (JIS)	Vc (m/min)	fz (mm/tooth)			Grade of Insert	
P Carbon Steel	P5	150~250	0.08~0.15	3	8	3	NC2032
	SCM440	150~250	0.08~0.15	3	8	2	NC2032
	SKD11	120~200	0.08~0.15	2	4	2	NC2032
M Stainless Steel	SUS304	80~120	0.04~0.08	1	4	2	NC2032
K Casting Iron Malleable Cast Iron, Grey Cast Iron	FC25	120~200	0.08~0.12	2	5	2	NC2032
		100~150	0.06~0.10	3	8	3	NC2032
N Al, Al-alloy	A6061	200~500	0.03~0.07	5	8	3	NC9031

▶ Surface Roughness Comparison

- Nine9 A series shoulder face mill insert receive a better result of surface finish.

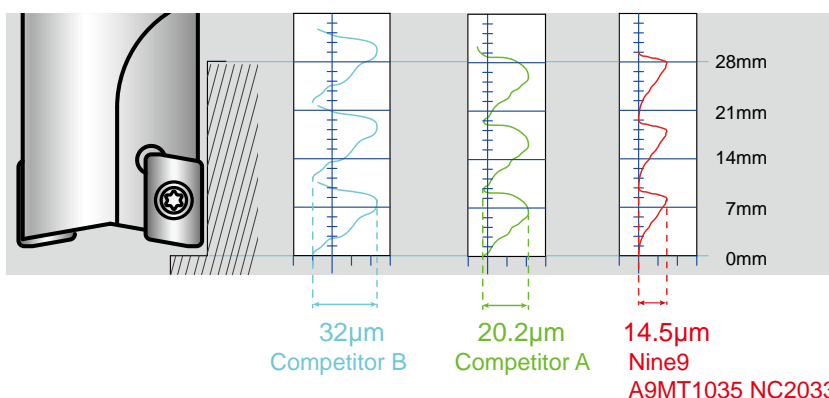

C Series Torus Radius Mills

► Features

- Good for corner finishing.
- Series C is developed for replacement of the other milling cutters with ram feed.

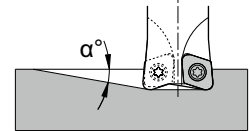

► Cylindrical Shank >>

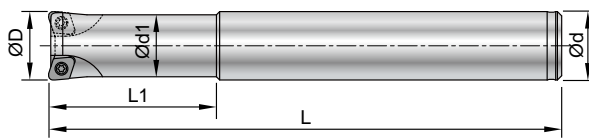

Part No.	Type	ØD	Ød h6	Ød1	α°	L1	L	⊕ Z	Insert type
00-99802-BC12-12C5	BC12-12C5	12	12	10.5	8.0	30	100	2	C9MT05T105 C9MT05T110H
00-99802-BC16-16C5	BC16-16C5	16	16	14.5	5.5	40	120	3	
00-99802-BC20-20C5	BC20-20C5	20	20	18	4.0	50	130	3	
00-99802-BC25-25C5	BC25-25C5	25	25	23	3.0	60	150	4	

► Screw-Fit Type >>

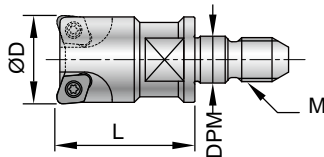

Part No.	Type	ØD	α°	L	M	DPM	⊕ Z	Insert type
00-99802-M05-10C4	M05-10C4	10	8	15	M5xP0.8	5.5	2	C9MT040105 C9MT040110
00-99802-M05-11C4	M05-11C4	11	6	15	M5xP0.8	5.5		
00-99802-M06-12C5	M06-12C5	12	8	25	M6xP1.0	6.5	2	C9MT05T105 C9MT05T110H
00-99802-M06-13C5	M06-13C5	13	7.5	25	M6xP1.0	6.5		
00-99802-M08-16C5	M08-16C5	16	5.5	25	M8xP1.25	8.5	3	
00-99802-M08-17C5	M08-17C5	17	5	25	M8xP1.25	8.5		
00-99802-M10-20C5	M10-20C5	20	4	30	M10xP1.5	10.5	4	
00-99802-M10-21C5	M10-21C5	21	3.5	30	M10xP1.5	10.5		
00-99802-M12-25C5	M12-25C5	25	3	35	M12xP1.75	12.5	4	
00-99802-M12-26C5	M12-26C5	26	2.5	35	M12xP1.75	12.5		
00-99805-M05-11C5	M05-11C5	11	10	13	M5xP0.8	5.5	2	C9MT05T105 C9MT05T110H
00-99805-M06-12C5	M06-12C5	12	8	13	M6xP1.0	6.5		
00-99805-M06-13C5	M06-13C5	13	7.5	13	M6xP1.0	6.5	3	
00-99805-M08-16C5	M08-16C5	16	5.5	15	M8xP1.25	8.5		
00-99805-M08-17C5	M08-17C5	17	5	15	M8xP1.25	8.5	3	
00-99805-M10-20C5	M10-20C5	20	4	15	M10xP1.5	10.5		
00-99805-M10-21C5	M10-21C5	21	3.5	15	M10xP1.5	10.5	4	
00-99805-M12-25C5	M12-25C5	25	3	20	M12xP1.75	12.5		
00-99805-M12-26C5	M12-26C5	26	2.5	20	M12xP1.75	12.5	4	

* Refer to page 9-156 for extension bars.

C Series Torus Radius Mills

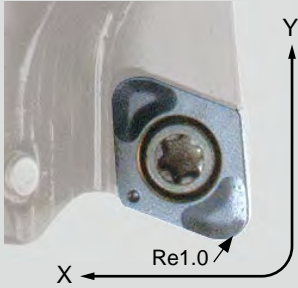

► Dual Relief Angle Insert

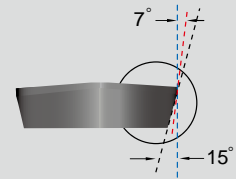

Higher feed rate!
Higher wearing resistance!

Insert

- Submicron carbide inserts are fully ground.
- Special design milling cutter and ground insert for semi-finishing 3D surface milling for mold industry.

NC30 : • Flat cutting edge design,
universal type for all kind of materials.

NC2032 : • High positive angle, special chip breaker design,
higher wearing resistance.
• Good for hardened material.

Parts No.	Coating	Grade		Dimensions			Screw	Key
				L	S	Re		
C9MT040105-NC30	AlTiN	K10F		4	1.59	0.5	*NS-18037 0.6Nm	NK-T6
C9MT040110-NC30	AlTiN	K10F		4	1.59	1.0		
C9MT05T105-NC30	AlTiN	K10F		5	2.0	0.5	*NS-20045 0.6Nm	NK-T6
C9MT05T110H-NC2032	AlTiN	K20F		5	2.0	1.0		

*Torque screwdriver is recommended.

Cutting Data

- Recommend Ae below 2.5mm.

Work Material	Sample Code (JIS)	Vc (m/min)	fz (mm/tooth)	 Ap(mm)	Grade of Insert
P Carbon Steel	P5	150~300	0.2~0.5	0.2~0.5	NC30
					NC2032
M Alloy Steel	SCM440	120~250	0.2~0.5	0.2~0.5	NC30
					NC2032
M Stainless Steel	SUS304	120~200	0.2~0.4	0.2~0.4	NC30
					NC2032
H Hardened Steel < HRC52	SKD61	100~150	0.1~0.3	0.1~0.3	NC2032



Cycle Time 

Roughness 

Position Accuracy 

True Roundness 

NineBore >>>

Nine9 offers a range of eccentrically mechanism boring tools which designed to provide stability, accuracy, and productivity in boring operations.

These tools are commonly used in industries such as automotive, aerospace, mold and die, and general machining.

99146 can complete rough and finish boring in one operation.

P M K N H

▶ **Easy Adjustment!**

▶ **No Backlash!**

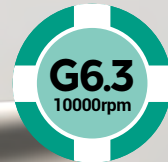

Features >>>

▶ **Easy Handling**

- Change the boring bar in just one minute.
- Dimensions are easy to read. They are indicated on the tools and are easily adjusted on a tool presetter or in machining center.
- Adjusting range : ± 0.1 mm

▶ **High Speed.**

- Good for fine boring operation on milling machines, machining centers and special purpose machines.
- Replace solid carbide reamers.

▶ **99146 Series Is Ideal For Casting Aluminum With Uncertain Pre-Hole Dimensions And Deviations In Hole Spacing.**



Applications

Rough and finish boring in one operation

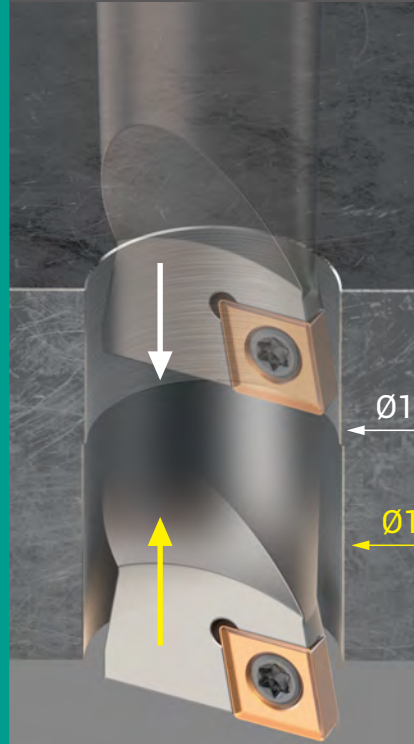
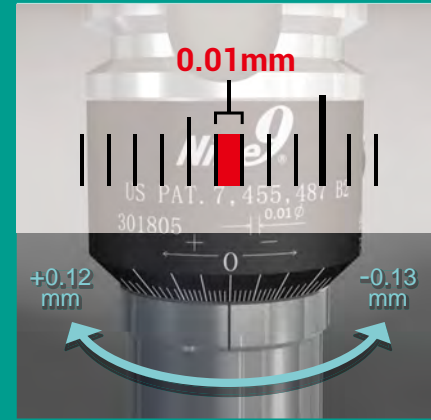

Ø14.9mm (Downward roughing)

Ø15.0mm (Upward finishing)

“ Ø5~Ø50mm boring bars are interchangeable, balanced grade is G6.3 10000 r.p.m., all sizes are guaranteed. ”

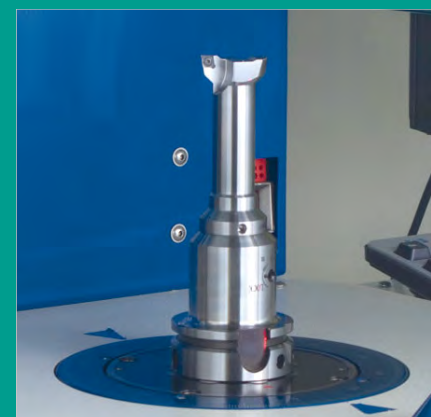

NineBore Boring Tool

9

NineBore Features

► Precisely pre-balanced the basic holder and the boring bar >>

- Balanced grade is maintained while adjusting boring dimension or change to different diameter boring bars.

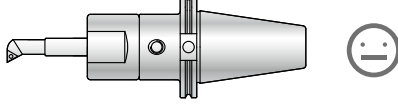
NineBore design	Other Boring Tool
	
<ul style="list-style-type: none"> • Pre-balanced 	<ul style="list-style-type: none"> • Without pre-balanced

► Application >>



- Ideal as small hole boring tool with excellent accuracy.
- For fine boring operation on milling machines, machining centres and special purpose machines.

► High Speed >>









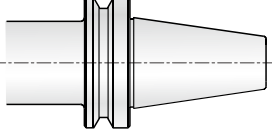

- Boring bar design ensures accurate high speed boring.
Balanced grade is G6.3 10000 r.p.m., all sizes are guaranteed.
- Combination bore / chamfer / facing / multi-task tools can be ordered on request.

► Economic >>

- Low cost micro adjustable boring heads.
- It can replace end mill and brazed tool bits.
- This simple boring tool has minimal components. In minutes, the boring bar can be changed and the boring dimension set on the tool presetter.

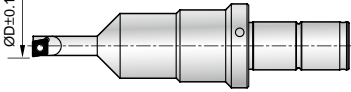
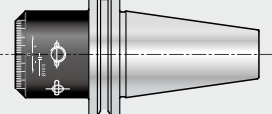
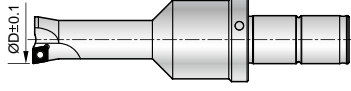
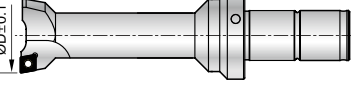
Work Task		
HoleØ : 10mm (H7 Tolerance) Hole Distance : 20mm		
Tool	NineBore 99146	Other Boring Tool
Workpiece material		N AL6061T6
CNC Code		G76
Spindle speed	r.p.m.	2500 r.p.m.
Feed rate f =	mm/rev.	0.07 mm/rev.
Feed rate F=	mm/min.	175mm/min.
RESULT		
Drilling time	sec.	10s 44
Hole 1 Ø	mm	Ø10.003 mm
Hole 2 Ø	mm	Ø9.990 mm
Hole Distance	mm	Ø19.98 mm
Comparison		

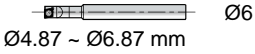
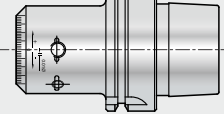
NineBore System

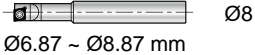
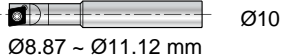
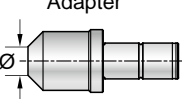
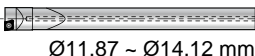
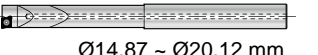
Series	Adjustment range	ØD range	Insert	Boring Bars	Head Shank
99101 Each Division 0.03 mm/div	±0.5mm	Ø 6.5 mm 25.5 mm	 CCGT030102 CCGT040102	 00-99101-07...25	Side lock holders Hydraulic chucks Spring collet chucks 
				 00-99121-05...25	
99121 Each Division 0.01 mm/div.	±0.1mm	Ø 4.9 mm 25.1 mm	CCGH060204	 00-99121-05...25	
G6.3 10000 r.p.m 99146 Each Division 0.01 mm/div.	+0.12mm -0.13mm	Ø 4.87 mm 50.12 mm	 CCGT030102 CCGT040102 CCGH060204	 Ø5 ~ Ø10 mm 00-99146-xxS	 00-99146-BT30H 00-99146-BT40H 00-99146-BT50H 00-99146-CAT40H
				 Ø11 ~ Ø25 mm 00-99146-xxS	
				 Ø26 ~ Ø39 mm 00-99146-xxA	
				 Ø40 ~ Ø50 mm 00-99146-xxA	
4-6XD 99151 Each Division 0.01 mm/div.	+0.12mm -0.13mm	Ø 4.87 mm 20.12 mm	 CCGT030102 CCGT040102 CCGH060204	 Ø6 Ø4.87 ~ Ø6.87 mm	 00-99146-HSK63AH  00-99146-SB32H
			 Ø8 Ø6.87 ~ Ø8.87 mm		
			 Ø10 Ø8.87 ~ Ø11.12 mm		
			Adapter  99151A-06...15.5		
			 Ø11 Ø11.87 ~ Ø14.12 mm		
			 Ø15.5 Ø14.87 ~ Ø20.12 mm		

99101 EMB Boring Bars 0.03 mm/div.

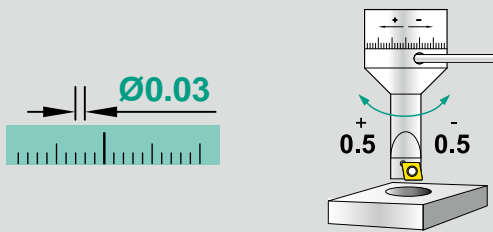

► Boring Bars >>

- Adjusted to required diameter by eccentric mechanism
- H type with internal coolant can be ordered on request from Dia. 7mm. Ordering example: 00-99101-07H.
- Other sizes are available on request.

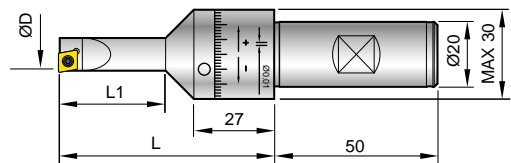

Part No.	Type		ØD	L1	L	Insert	Screw / Key		
00-99101-07	SB20-0721-03	Adjustment range:±0.5mm Each Division 0.03mm	6.5-7.5	21	60	CC...040102	*NS-20036 0.6Nm / NK-T6		
00-99101-08	SB20-0824-03		7.5-8.5	24	63				
00-99101-09	SB20-0927-03		8.5-9.5	27	65			CC...0602...	*NS-25045 0.9Nm / NK-T7
00-99101-10	SB20-1030-03		9.5-10.5	30	68				
00-99101-11	SB20-1133-03		10.5-11.5	33	70				
00-99101-12	SB20-1236-03		11.5-12.5	36	73				
00-99101-13	SB20-1339-03		12.5-13.5	39	75				
00-99101-14	SB20-1442-03		13.5-14.5	42	78				
00-99101-15	SB20-1545-03		14.5-15.5	45	80				
00-99101-16	SB20-1648-03		15.5-16.5	48	83	CC...0602...	*NS-25060 0.9Nm / NK-T7		
00-99101-17	SB20-1751-03		16.5-17.5	51	85				
00-99101-18	SB20-1850-03		17.5-18.5	50	82				
00-99101-19	SB20-1950-03		18.5-19.5	50	82				
00-99101-20	SB20-2050-03		19.5-20.5	50	82				
00-99101-21	SB20-2150-03		20.5-21.5	50	82				
00-99101-22	SB20-2250-03		21.5-22.5	50	82				
00-99101-23	SB20-2350-03		22.5-23.5	50	82				
00-99101-24	SB20-2450-03		23.5-24.5	50	82				
00-99101-25	SB20-2550-03		24.5-25.5	50	82				

*Torque screwdriver is recommended.

99121 EMB Boring Bars 0.01 mm/div.

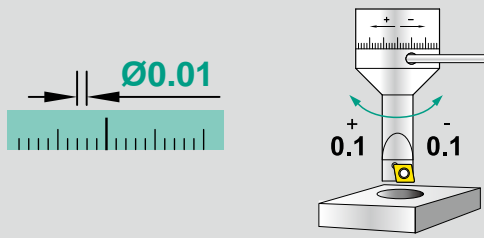

► Boring Bars >>

- Adjusted to required diameter by eccentric mechanism
- H type with internal coolant can be ordered on request from Dia. 7mm. Ordering example: 00-99121-07H.
- Other sizes are available on request.

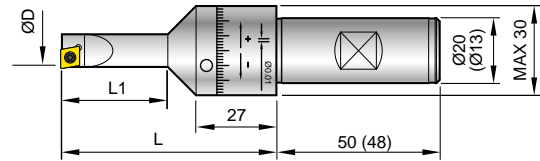

Part No.	Type		ØD	L1	L	Insert	Screw / Key		
00-99121-05	SB20-0515-01	Adjustment range: ±0.1mm Each Division 0.01mm	4.9-5.1	15	54	CC...030102	*NS-16030 0.4Nm / NK-T6		
00-99121-06	SB20-0618-01		5.9-6.1	18	57				
00-99121-07	SB20-0721-01		6.9-7.1	21	60	CC...040102	*NS-20036 0.6Nm / NK-T6		
00-99121-08	SB20-0824-01		7.9-8.1	24	63				
00-99121-09	SB20-0927-01		8.9-9.1	27	65	CC...0602...	*NS-25045 0.9Nm / NK-T7		
00-99121-10	SB20-1030-01		9.9-10.1	30	68				
00-99121-11	SB20-1133-01		10.9-11.1	33	70				
00-99121-12	SB20-1236-01		11.9-12.1	36	73				
00-99121-13	SB20-1339-01		12.9-13.1	39	75				
00-99121-14	SB20-1442-01		13.9-14.1	42	78				
00-99121-15	SB20-1545-01		14.9-15.1	45	80				
00-99121-16	SB20-1648-01		15.9-16.1	48	83			CC...0602...	*NS-25060 0.9Nm / NK-T7
00-99121-17	SB20-1751-01		16.9-17.1	51	85				
00-99121-18	SB20-1850-01		17.9-18.1	50	82				
00-99121-19	SB20-1950-01		18.9-19.1	50	82				
00-99121-20	SB20-2050-01		19.9-20.1	50	82				
00-99121-21	SB20-2150-01		20.9-21.1	50	82				
00-99121-22	SB20-2250-01		21.9-22.1	50	82				
00-99121-23	SB20-2350-01		22.9-23.1	50	82				
00-99121-24	SB20-2450-01		23.9-24.1	50	82				
00-99121-25	SB20-2550-01		24.9-25.1	50	82				

*Torque screwdriver is recommended.

99146 Quick Change High Speed EMB Boring Bar

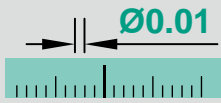

► Boring Head Shank >>

• HSK63

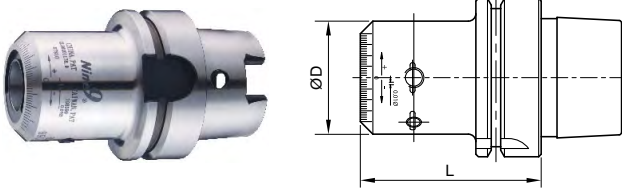

• CAT40

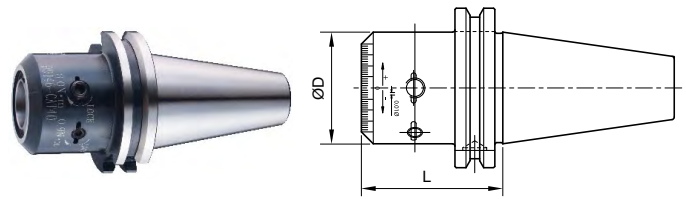

• BT

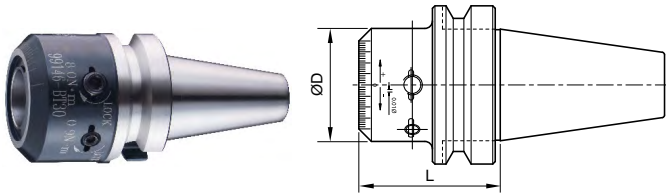

• SB32

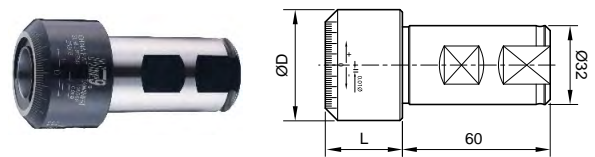

Part No.	Type	ØD	L	M8 Screw		M6 Screw	
				Spring Fingers	Locking Screw	Spring Fingers	Pre-load Screw
00-99146-HSK63AH	HSK63A-146-72	45	72.0	NP-F0002	NS-08060 8.0 Nm	NP-F0003	NS-06045 0.9 Nm
00-99146-CAT40H	CAT40-146-56	45	56.3				
00-99146-BT30H	BT30-146-51	45	51.3				
00-99146-BT40H	BT40-146-56	45	56.3				
00-99146-BT50H	BT50-146-77	45	77.3				
00-99146-SB32H	SB32-146-31	45	31.3				

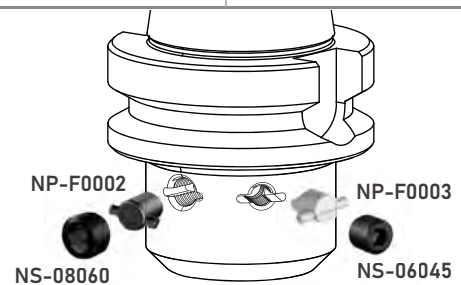

99146 Quick Change High Speed EMB Boring Bar

► Boring Bar Ø5~Ø25 >>

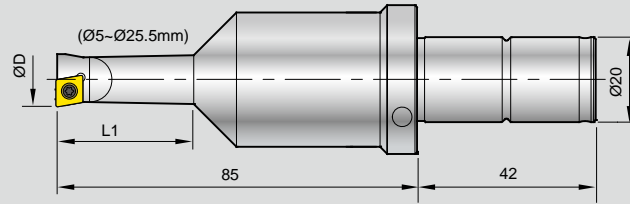

- Alloy Steel Shank. Boring Depth : L1, 2~3xD
- H type with internal coolant can be ordered on request from Dia. 10mm.
Ordering example: 00-99146-1000SH.
- Other sizes are available on request.

Part No.	Type	ØD	L1	Insert Screw / Key	Part No.	Type	ØD	L1	Insert Screw / Key
00-99146-0500S	C20-0500-10L	4.87~5.12	10.00	CC...030102 *NS-16030	00-99146-1725S	C20-1725-42L	17.12~17.37	42.50	CC...0602... *NS-25060 0.9Nm NK-T7
00-99146-0600S	C20-0600-12L	5.87~6.12	12.00	0.4Nm / NK-T6	00-99146-1750S	C20-1750-43L	17.37~17.62	43.75	
00-99146-0700S	C20-0700-14L	6.87~7.12	14.00	CC...040102 *NS-20036,	00-99146-1775S	C20-1775-43L	17.62~17.87	45.00	
00-99146-0800S	C20-0800-16L	7.87~8.12	16.00	0.6Nm / NK-T6	00-99146-1800S	C20-1800-45L	17.87~18.12		
00-99146-0900S	C20-0900-18L	8.87~9.12	18.00	25.00	00-99146-1825S	C20-1825-45L	18.12~18.37		
00-99146-1000S	C20-1000-25L	9.87~10.12	18.00		00-99146-1850S	C20-1850-46L	18.37~18.62	46.25	
00-99146-1025S	C20-1025-25L	10.12~10.37	26.25	00-99146-1875S	C20-1875-46L	18.62~18.87	47.50		
00-99146-1050S	C20-1050-26L	10.37~10.62	27.50	00-99146-1900S	C20-1900-47L	18.87~19.12		48.75	
00-99146-1075S	C20-1075-26L	10.62~10.87	28.75	00-99146-1925S	C20-1925-47L	19.12~19.37	50.00		
00-99146-1100S	C20-1100-27L	10.87~11.12	30.00	00-99146-1950S	C20-1950-48L	19.37~19.62		CC...0602... *NS-25060 0.9Nm NK-T7	
00-99146-1125S	C20-1125-27L	11.12~11.37	31.25	00-99146-1975S	C20-1975-48L	19.62~19.87			
00-99146-1150S	C20-1150-28L	11.37~11.62	32.50	00-99146-2000S	C20-2000-50L	19.87~20.12	CC...0602... *NS-25060 0.9Nm NK-T7		
00-99146-1175S	C20-1175-28L	11.62~11.87	33.75	00-99146-2025S	C20-2025-50L	20.12~20.37			
00-99146-1200S	C20-1200-30L	11.87~12.12	35.00	00-99146-2050S	C20-2050-50L	20.37~20.62			
00-99146-1225S	C20-1225-30L	12.12~12.37	36.25	00-99146-2075S	C20-2075-50L	20.62~20.87			
00-99146-1250S	C20-1250-31L	12.37~12.62	37.50	00-99146-2100S	C20-2100-50L	20.87~21.12			
00-99146-1275S	C20-1275-31L	12.62~12.87	38.75	00-99146-2125S	C20-2125-50L	21.12~21.37			
00-99146-1300S	C20-1300-32L	12.87~13.12	40.00	00-99146-2150S	C20-2150-50L	21.37~21.62			
00-99146-1325S	C20-1325-32L	13.12~13.37	41.25	00-99146-2175S	C20-2175-50L	21.62~21.87			
00-99146-1350S	C20-1350-33L	13.37~13.62	42.50	00-99146-2190S	C20-2190-50L	21.87~22.12			
00-99146-1375S	C20-1375-33L	13.62~13.87	44.00	00-99146-2200S	C20-2200-50L	21.87~22.12			
00-99146-1400S	C20-1400-35L	13.87~14.12	45.50	00-99146-2225S	C20-2225-50L	22.12~22.37			
00-99146-1425S	C20-1425-35L	14.12~14.37	47.00	00-99146-2250S	C20-2250-50L	22.37~22.62			
00-99146-1450S	C20-1450-36L	14.37~14.62	48.50	00-99146-2275S	C20-2275-50L	22.62~22.87			
00-99146-1475S	C20-1475-36L	14.62~14.87	50.00	00-99146-2300S	C20-2300-50L	22.87~23.12			
00-99146-1500S	C20-1500-37L	14.87~15.12	51.50	00-99146-2325S	C20-2325-50L	23.12~23.37			
00-99146-1525S	C20-1525-37L	15.12~15.37	53.00	00-99146-2350S	C20-2350-50L	23.37~23.62			
00-99146-1550S	C20-1550-38L	15.37~15.62	54.50	00-99146-2375S	C20-2375-50L	23.62~23.87			
00-99146-1575S	C20-1575-38L	15.62~15.87	56.00	00-99146-2400S	C20-2400-50L	23.87~24.12			
00-99146-1600S	C20-1600-40L	15.87~16.12	57.50	00-99146-2425S	C20-2425-50L	24.12~24.37			
00-99146-1625S	C20-1625-40L	16.12~16.37	59.00	00-99146-2450S	C20-2450-50L	24.37~24.62			
00-99146-1650S	C20-1650-41L	16.37~16.62	60.50	00-99146-2475S	C20-2475-50L	24.62~24.87			
00-99146-1675S	C20-1675-41L	16.62~16.87	62.00	00-99146-2500S	C20-2500-50L	24.87~25.12			
00-99146-1700S	C20-1700-42L	16.87~17.12	63.50	00-99146-2525S	C20-2525-50L	25.12~25.37			
				00-99146-2550S	C20-2550-50L	25.37~25.62			

*Torque screwdriver is recommended.

99146 Quick Change High Speed EMB Boring Bar

▶ Boring Bar Ø26~Ø39 >>

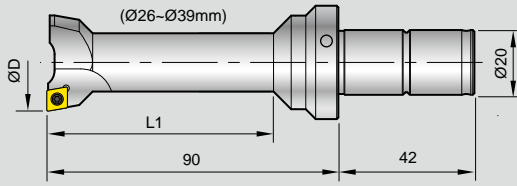

▶ Boring Bar Ø40~Ø50 >>

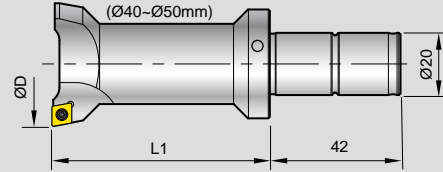

- Alloy Steel Shank. Boring Depth : L1, 2~3xD
- H type with internal coolant can be ordered on request from Dia. 10mm.
Ordering example: 00-99146-36AH.
- Other sizes are available on request.

Part No.	Type	ØD	L1	Insert Screw / Key	Part No.	Type	ØD	L1	Insert Screw / Key
00-99146-26A	C20-2600-50L	25.87~26.12	50	CC...0602... *NS-25060 0.9Nm NK-T7	00-99146-40A	C20-4000-70L	39.87-40.12	70	CC...0602... *NS-25060 0.9Nm NK-T7
00-99146-27A	C20-2700-50L	26.87~27.12			00-99146-41A	C20-4100-70L	40.87-41.12		
00-99146-28A	C20-2800-50L	27.87~28.12			00-99146-42A	C20-4200-70L	41.87-42.12		
00-99146-29A	C20-2900-50L	28.87~29.12			00-99146-43A	C20-4300-70L	42.87-43.12		
00-99146-30A	C20-3000-50L	29.87~30.12			00-99146-44A	C20-4400-70L	43.87-44.12		
00-99146-31A	C20-3100-70L	30.87~31.12			00-99146-45A	C20-4500-70L	44.87-45.12		
00-99146-32A	C20-3200-70L	31.87~32.12	00-99146-46A		C20-4600-70L	45.87-46.12			
00-99146-33A	C20-3300-70L	32.87~33.12	00-99146-47A		C20-4700-70L	46.87-47.12			
00-99146-34A	C20-3400-70L	33.87~34.12	00-99146-48A		C20-4800-70L	47.87-48.12			
00-99146-35A	C20-3500-70L	34.87~35.12	00-99146-49A		C20-4900-70L	48.87-49.12			
00-99146-36A	C20-3600-70L	35.87~36.12	00-99146-50A		C20-5000-70L	49.87-50.12			
00-99146-37A	C20-3700-70L	36.87~37.12							
00-99146-38A	C20-3800-70L	37.87~38.12							
00-99146-39A	C20-3900-70L	38.87~39.12							

*Torque screwdriver is recommended.

▶ High Speed Boring Bar Kit >>

Part No.	Contents
00-99146-SB32H-05SET	SB32-146-31 Weldon Shank
00-99146-BT30-05SET	BT30H Boring head shank
00-99146-BT40-05SET	BT40H Boring head shank
00-99146-BT50-05SET	BT50H Boring head shank
00-99146-CAT40-05SET	CAT40H Boring head shank
00-99146-HSK63A-05SET	HSK63A Boring head shank

Boring head shank: 1pc
Boring bar: any 5 pcs from Ø5~Ø50
Key: 3~5 pcs
Plastic box: 1pc



- (Insert is not included, please order separately)
- Note: BT50 boring head shank is packed in a separate box.

Application Example

► Machining a cover of scooter engine:

Workpiece material:
Die casting, Al-alloy, ADC-12(A383)
Spindle Size: BT40

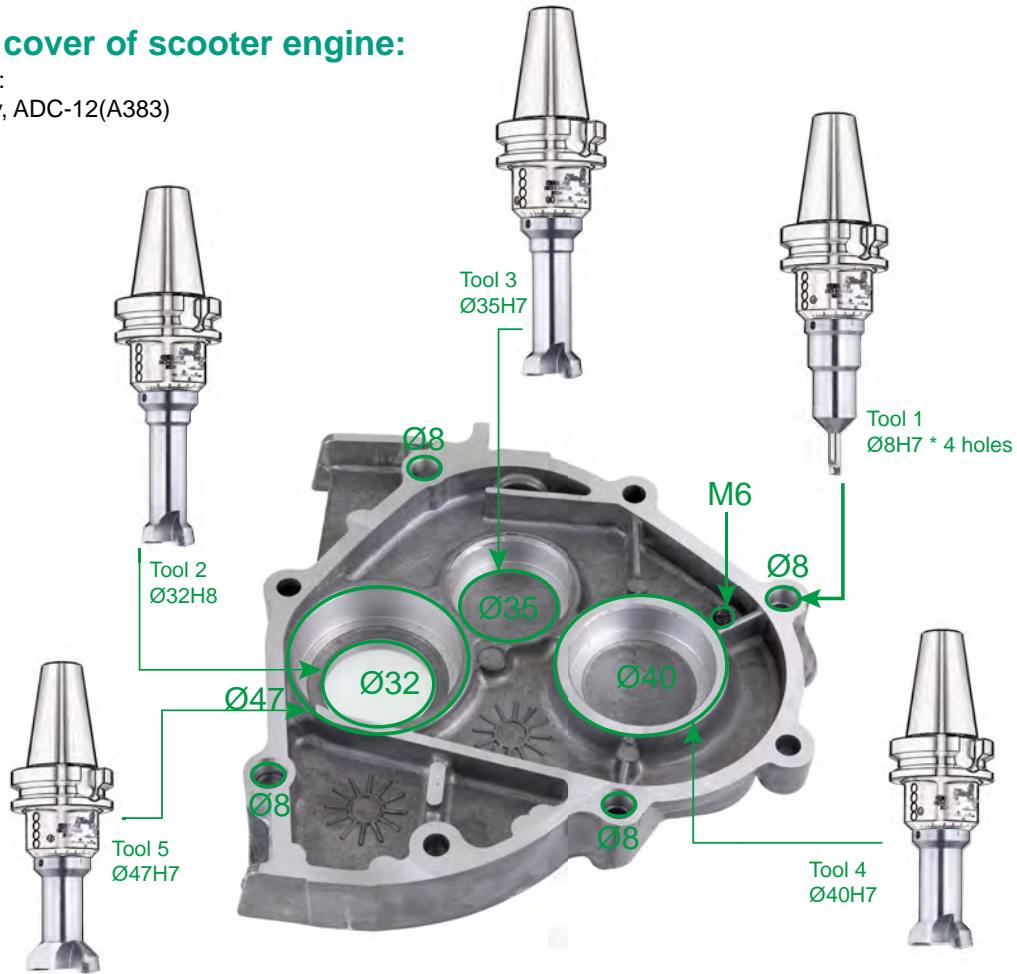

TOOL LIST by Nine9 Boring Bar 99146-series :

No.	Boring Bar	Grade of insert	Dia. mm	Depth	r.p.m.	F = mm/min.	Machining time
1	00-99146-08A	CCGT040102 NC30	Ø8H7	8 mm	8000	400	1.2 sec.
2	00-99146-32A	CCFT060204HP NC9031	Ø32H8	8 mm	2985	209	2.3 sec.
3	00-99146-35A		Ø35H7	12 mm	2730	191	3.8 sec.
4	00-99146-40A		Ø40H7	15 mm	2400	168	5.4 sec.
5	00-99146-47A		Ø47H7	15 mm	2030	142	6.4 sec.

► Example >>

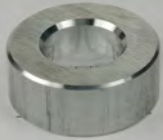
	Material	Vc m/min.	f mm/rev.	Roughness			Tool holder	Insert
				Ra	Rz	Rmax		
	Al alloy, 6061	150	0.2	0.076µm	0.50µm	0.6µm	99146-BT40-26A	CCGH0602U NC9036

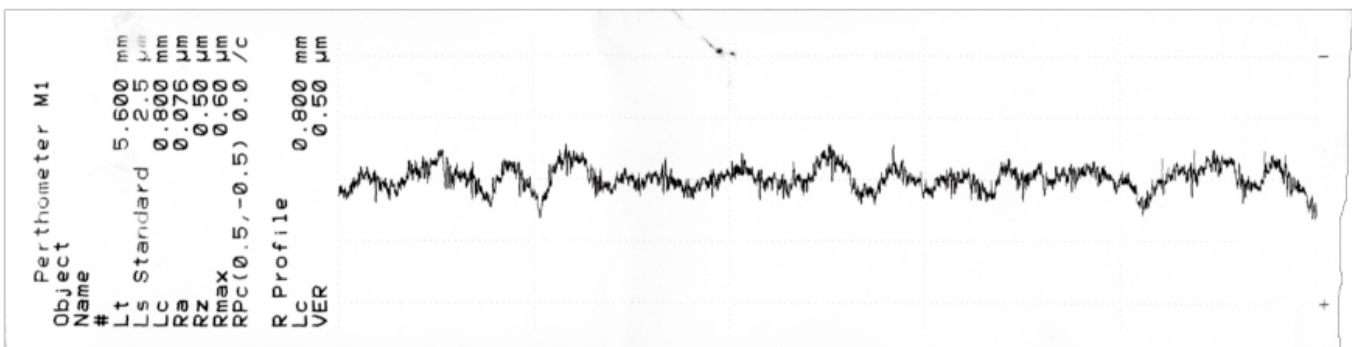

99151 Deep hole boring 4~6XD

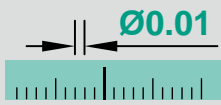

► 99151 System >>

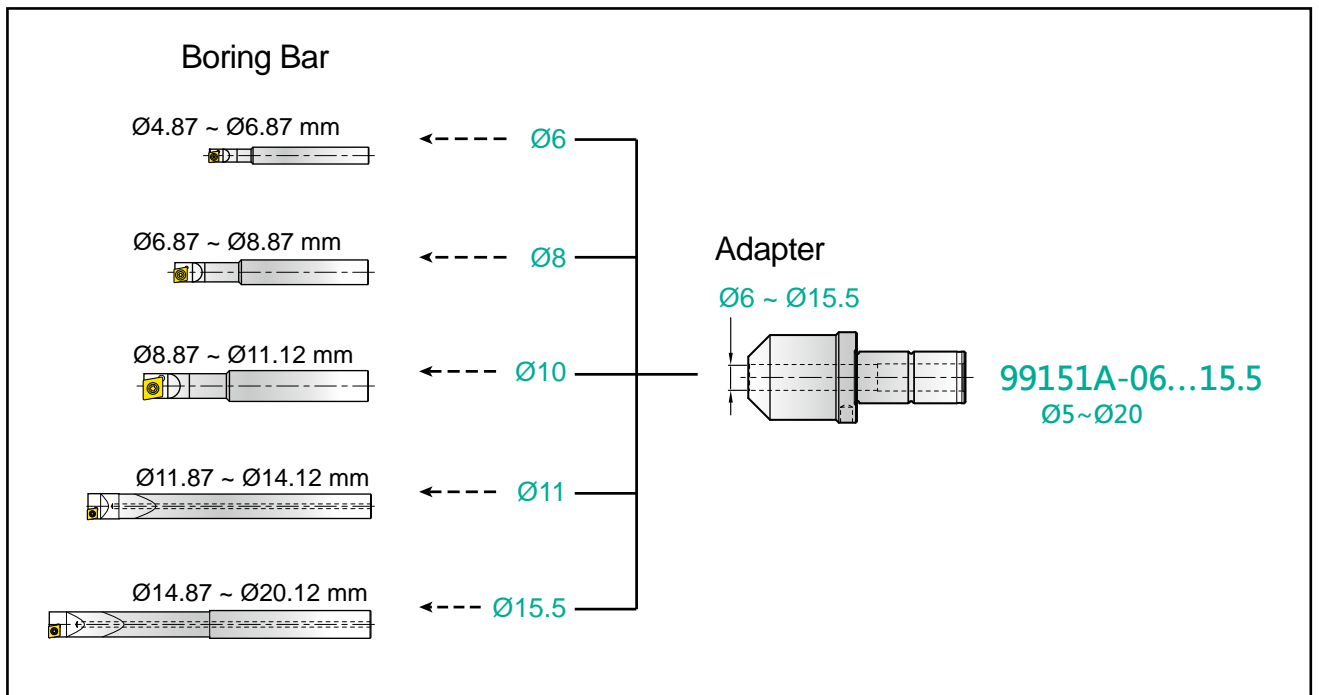

► Adapter >>

- Economical solution of small dia. boring bar.

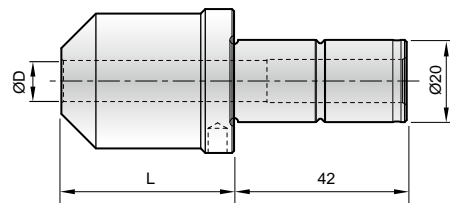

Part No.	Type	ØD	L
00-99151A-06	C20-ID06	6	52
00-99151A-08	C20-ID08	8	49
00-99151A-10	C20-ID10	10	42
00-99151A-11	C20-ID11	11	21.5
00-99151A-15.5	C20-ID15.5	15.5	21.5

99151 Deep hole boring 4~6XD

► Boring Bar Ø5~Ø20 >>

- Solid Carbide Shank
- Boring Depth : L1, 4~6xD

Part No.	Type	ØD	Ød	Ød1	L1	L	Insert Screw / Key	Fig.
00-99151-0500W	C06-0500-20L	4.87~5.12	6	-	20	70	CCGT030102 *NS-16030 / 0.4Nm NK-T6	
00-99151-0525W	C06-0525-20L	5.12~5.37		-				
00-99151-0550W	C06-0550-22L	5.37~5.62		-				
00-99151-0575W	C06-0575-22L	5.62~5.87		-				
00-99151-0600W	C06-0600-24L	5.87~6.12		-				
00-99151-0625W	C06-0625-24L	6.12~6.37		-				
00-99151-0650W	C06-0650-26L	6.37~6.62		-				
00-99151-0675W	C06-0675-26L	6.62~6.87		-				
00-99151-0700W	C08-0700-28L	6.87~7.12	8	-	28	85	CCGT040102 *NS-20036 / 0.6Nm NK-T6	
00-99151-0725W	C08-0725-28L	7.12~7.37		-				
00-99151-0750W	C08-0750-30L	7.37~7.62		-				
00-99151-0775W	C08-0775-30L	7.62~7.87		-				
00-99151-0800W	C08-0800-32L	7.87~8.12		-				
00-99151-0825W	C08-0825-32L	8.12~8.37		-				
00-99151-0850W	C08-0850-34L	8.37~8.62		-				
00-99151-0875W	C08-0875-34L	8.62~8.87		-				
00-99151-0900W	C10-0900-36L	8.87~9.12	10	-	36	110	CC...0602... *NS-25045 / 0.9Nm NK-T7	
00-99151-0925W	C10-0925-36L	9.12~9.37		-				
00-99151-0950W	C10-0950-38L	9.37~9.62		-				
00-99151-0975W	C10-0975-38L	9.62~9.87		-				
00-99151-1000W	C10-1000-40L	9.87~10.12		-				
00-99151-1025W	C10-1025-40L	10.12~10.37		-				
00-99151-1050W	C10-1050-42L	10.37~10.62		-				
00-99151-1075W	C10-1075-42L	10.62~10.87		-				
00-99151-1100W	C10-1100-44L	10.87~11.12	-					
00-99151-1200WS	C11-1200-120L	11.87~12.12	11	11	70	120	CC...0602... *NS-25045 / 0.9Nm NK-T7	
00-99151-1300WS	C11-1300-120L	12.87~13.12		-				
00-99151-1400WS	C11-1400-120L	13.87~14.12		-				
00-99151-1500W	C15.5-1500-180L	14.87~15.12	15.5	14	90	180	CC...0602... *NS-25060 / 0.9Nm NK-T7	
00-99151-1600W	C15.5-1600-180L	15.87~16.12	15.5	15	90	180		
00-99151-1700W	C15.5-1700-180L	16.87~17.12		-				
00-99151-1800W	C15.5-1800-180L	17.87~18.12		-				
00-99151-1900W	C15.5-1900-180L	18.87~19.12		-				
00-99151-2000W	C15.5-2000-180L	19.87~20.12		-				

*Torque screwdriver is recommended.

Procedures For Assembly

1. Use 4 mm allen-key to **loosen locking screw M8**, take care not to remove the screw.
2. Use 3 mm allen-key to **loosen pre-load screw M6**, take care not to remove the screw.
3. Remove the original boring bar and insert the new boring bar.
4. **Tighten the M6 pre-load screw**. Recommended torque = 0.9 ~ 1.0Nm.
5. Measure the boring diameter of the boring bar using tool presetter and adjust it to the required diameter.
6. **Tighten the M8 locking screw**. Recommended torque = 8 ~ 9Nm.

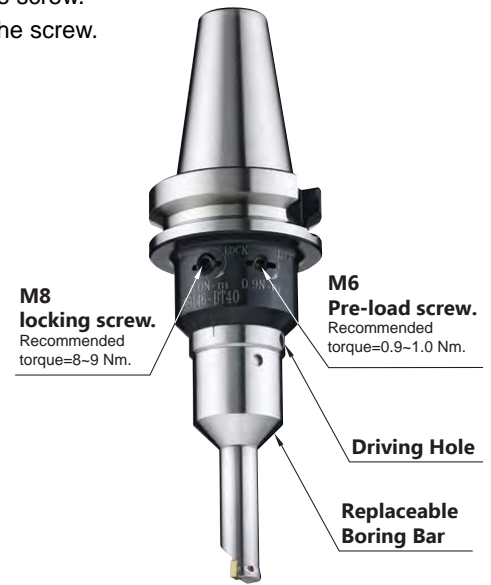
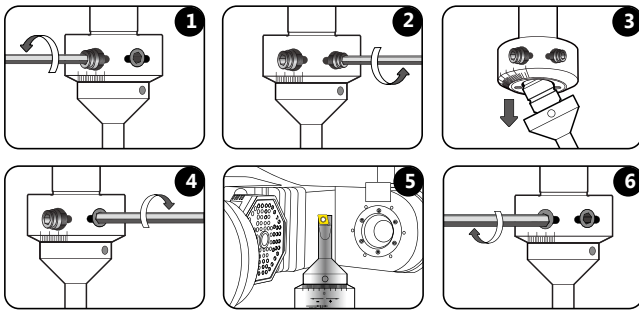

Procedures For Adjustment

On Tool Presetter

1. Loosen M8 locking screw.
2. Set the boring bar at the neutral position. (Step 1)
3. Measure the boring diameter using the tool presetter and compare with the required diameter. (Step 2)
4. If boring diameter is too big or too small, please put an allen-key into the adjusting driving hole. Turn to “ + ” to increase and turn to “ - ” to reduce boring diameter. (Step 3 and 4)
5. Tighten M8 locking screw.

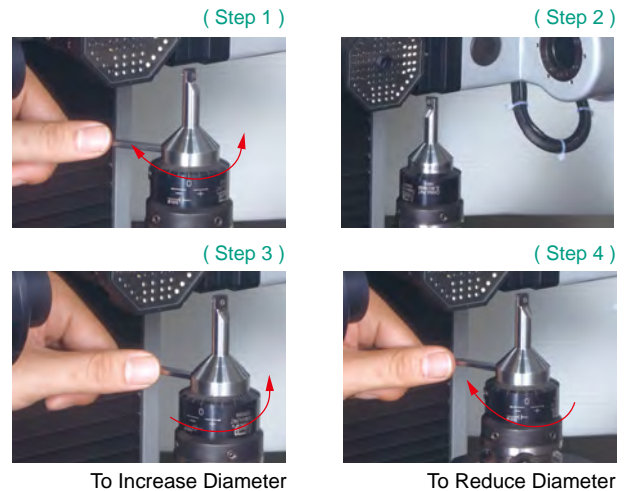

On Milling Machine and Machining Centers

1. Set the boring bar at the neutral position. (Step 1)
2. Tighten M8 locking screw.
3. Test cut on work piece, about 3-5mm depth on the machine.
4. Measuring boring diameter of workpiece and compare with required diameter.
5. If boring diameter is too big or too small, loosen M8 locking screw, please put an allen-key into the adjusting driving hole. Turn to “ + ” to increase and turn to “ - ” to reduce boring diameter. (Step 2 and 3)
6. Tighten M8 locking screw. (Step 4)

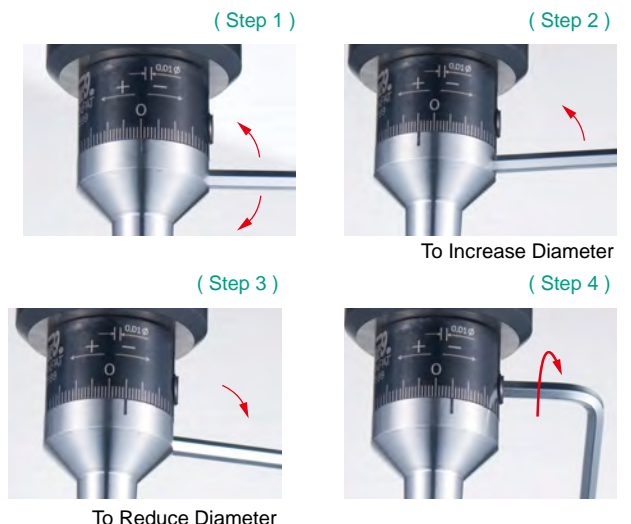

Precisely Ground Inserts

NC30 : • Universal grade for casting iron, carbon steel, alloy steel, stainless steel.

NC2032 : • For high speed cutting of casting iron.

NC2033 : • Good for carbon steel, alloy steel, stainless steel.

NC9036 : • long tool life.

• Good for Al, Al-alloy, Copper and non-ferrous metal.

U-XP9001 : • Super finishing insert with special specified cutting width 0.15mm radius for high feed rate.

• Good for Al, Al-alloy and non-ferrous metal.

Parts No.	Coating	Grade	Dimensions			Screw	Key	
			lc	S	Re			
CCGT030102	NC30	TiAlN	K20F	3.5	1.4	0.2	*NS-16030 0.4Nm	NK-T6
	NC9036	DLC						
CCGT040102	NC30	TiAlN	K20F	4.3	1.8	0.2	*NS-20036 0.6Nm	NK-T6
	NC9036	DLC						
CCGH0602U	U-XP9001	Uncoated	K20F			-		
CCFT060204	NC2033	TiAlN	K20F	6.35	2.38	0.4	*NS-25045 0.9Nm	NK-T7
	NC9036	DLC						
CCFW060204	NC2032	AlTiN	K20F			0.4		

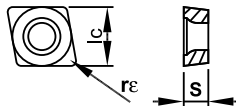

*Torque screwdriver is recommended.

Cutting Data

Spindle speed $S = \frac{V_c \times 1000}{\pi \times D}$ r.p.m. Feed rate: $f \times S$ mm/min.

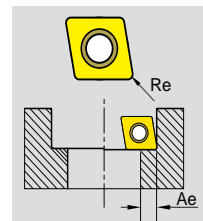

Workpiece Material	Cutting conditions or surface finishes	Cutting Speed Vc(m/min.)	feed rate f (mm/rev.)	Re0.2	Re0.4	Grade of Insert
				Ae (mm)		
P Carbon Steel	Regular cutting	120-150-200	0.05-0.07-0.10	0.05	0.1	NC2033
	Interrupted cutting	100-120-140	0.04-0.05-0.08	0.05	0.1	NC30
M Alloy Steel	Regular cutting	100-120-140	0.05-0.07-0.10	0.05	0.1	NC2033
	Interrupted cutting	80-100-120	0.04-0.05-0.08	0.05	0.1	NC30
K Stainless Steel	Regular cutting	80-100-120	0.05-0.07-0.10	0.05	0.1	NC2033
	Interrupted cutting	70-80-100	0.05-0.07-0.10	0.05	0.1	NC30
K Cast Iron	Regular cutting	80-100-120	0.05-0.07-0.10	0.05	0.1	NC2032 NC30
	Regular cutting	150-200-300	0.05-0.07-0.10	0.05	0.1	NC9036
N Brass, Bronze and Al-alloy Si >6%	Super mirror finish	150-200-300	0.15-0.2-0.25	0.15		U-XP9001
	Regular cutting	150-200-300	0.05-0.07-0.10	0.05	0.1	NC9036
N Al, Al-alloy, non-ferrous metal	Super mirror finish	150-200-300	0.15-0.20-0.25	0.15		U-XP9001
	Regular cutting	80-100-120	0.04-0.06-0.08	0.05	0.1	NC30
H Hardened Steel <HRC 50	Regular cutting	80-100-120	0.04-0.06-0.08	0.05	0.1	NC30

Extension Bar

For ACE Spot Drill, NC Spot Drill, Chamfer Mill, NC Helix Drill, Power Mill.

► Steel Type >>

- T is the maximum overhang length.
- With internal coolant hole.

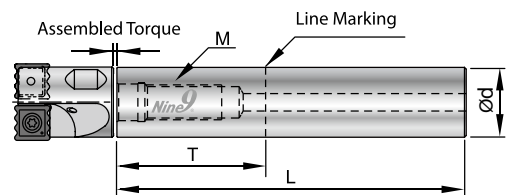

Part No.	Type	Ød	T	L	M	Assemble Torque
00-99801-08S	BC08-060M04S	8	10	60	M4xP0.7	3.5 Nm
00-99801-10S	BC10-075M05S	10	25	75	M5xP0.8	6.5 Nm
00-99801-12S	BC12-075M06S	12	25	75	M6xP1.0	11.0 Nm
00-99801-14S	BC14-090M08S	14	30	90	M8xP1.25	25.0 Nm
00-99801-16S	BC16-090M08S	16	35	90	M8xP1.25	25.0 Nm
00-99801-18S	BC18-100M10S	18	40	100	M10xP1.5	50.0 Nm
00-99801-20S	BC20-100M10S	20	40	100	M10xP1.5	50.0 Nm
00-99801-25S	BC25-120M12S	25	50	120	M12xP1.75	60.0 Nm

► Solid Carbide Type >>

- T is the maximum overhang length.
- With internal coolant hole.

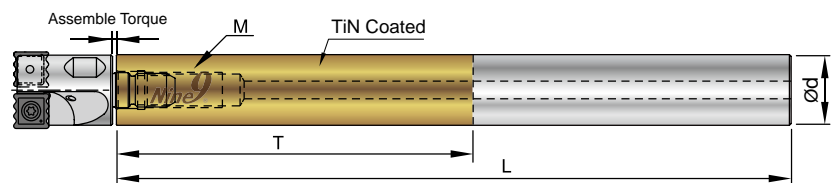

Part No.	Type	Ød	T	L	M	Assemble Torque
00-99801-08W	BC08-075M04W	8	25	75	M4xP0.7	3.5 Nm
00-99801-10W	BC10-100M05W	10	50	100	M5xP0.8	6.5 Nm
00-99801-12W	BC12-100M06W	12	60	100	M6xP1.0	11.0 Nm
00-99801-14W	BC14-120M08W	14	70	120	M8xP1.25	25.0 Nm
00-99801-16W	BC16-150M08W	16	80	150	M8xP1.25	25.0 Nm
00-99801-18W	BC18-150M10W	18	90	150	M10xP1.5	50.0 Nm
00-99801-20W	BC20-200M10W	20	100	200	M10xP1.5	50.0 Nm
00-99801-25W	BC25-200M12W	25	125	200	M12xP1.75	60.0 Nm

Notes

A large grid of dashed lines for taking notes, covering most of the page below the 'Notes' header.



No Need To Choose Nine9 Does It All



Always Better

JIMMORE
International Corp.

